

The
professional's
choice

Dive
Dacor
1974

DACOR



Dive Dacor 1974

There's a growing emphasis on the importance of professionalism in our industry. During the last 20 years that we have been manufacturing diving equipment, Dacor has helped pioneer this professional approach by producing the finest SCUBA products under the industry's most rigid quality standards.

We recognized the importance of making our products meet the exacting standards of the men who teach, work and explore the sea. Through our extensive research and development program, we have supplied innovative new products.

This all new, 48 page, full color catalog shows our line from beginning to end. There's a broad selection in many areas where a diver's personal preference is important—fins, masks, snorkels, spear guns, regulators, instruments, knives, safety devices, etc. The confidence that Dacor has built into these products is your assurance that they meet our demands of exacting professionalism.

Professionalism to us means that each step in production—research and development, engineering, manufacturing and product testing—is performed by professional people in the best facilities with the most modern equipment. Dacor's headquarters and manufacturing facilities in Northfield, Illinois, were designed to meet the needs of a growing sport and industry.

The key people in our company are divers who understand the needs of our customers and are dedicated to our role in the industry. This keen insight has made it possible for Dacor to develop revolutionary new products year after year.

Our long term and consistent commitment to the development of our industry and sport have made our products the "Professional's Choice."



Dacor equipment is used exclusively in a new recently released motion picture—SCUBA.

The professional's choice



Dacor People

At Dacor our people are our most valuable asset. Many are expert divers who have the drive, imagination and dedication to produce superior products for the diving industry.

Dacor recommends that a certified course of instruction be taken before using SCUBA equipment. Consult your local Dacor dealer.



Dive Dacor 1974



Dacor Quality

Our up-to-date manufacturing facilities include specially designed clean rooms with sophisticated testing facilities. Dacor's professional technicians make sure all our equipment meets the highest standards of excellence.



The professional's choice

Underwater Photography

We are interested and totally involved in all aspects of the SCUBA field, including underwater photography which has become a major interest in our sport. The underwater photographs in this catalog were taken by Dacor personnel.



TABLE OF CONTENTS

Olympic Regulators _____	6-10	Depth Gauges _____	24-25	Accessories _____	38-39
Aluminum Tanks _____	11	Watch and Compasses _____	26	Spearguns _____	40-41
Steel Tanks _____	12-13	Pressure Gauges _____	27	Pole Spears, Spear Tips, Game Bags _____	42-43
Full Foot Corda Fins _____	14	Wet Suits _____	28-29	Compressor & Air Station Supplies _____	44
Turbo Fins _____	15	Inflatable Vests _____	30-32	Instruction Text Books _____	45
Turbo II Quadavent Fins _____	16	Safety Flag, Floats _____	32	Decompression Tables _____	46
Masks _____	17-19	Knives and Diver's Tool _____	33	Instruction Aids on Mechanical Aspects _____	47
Snorkels _____	20-21	Lights _____	34-35		
Back Packs _____	22	Weight Belts & Lead Weights _____	36		
Tank Boots _____	22	Clothing & Equipment Bags _____	37		
Tank Valves _____	23				

Dacor Olympic Regulators

Balanced First Stage Models 400 and 800

Provides absolute minimum breathing effort and maximum air flow, regardless of tank pressure.

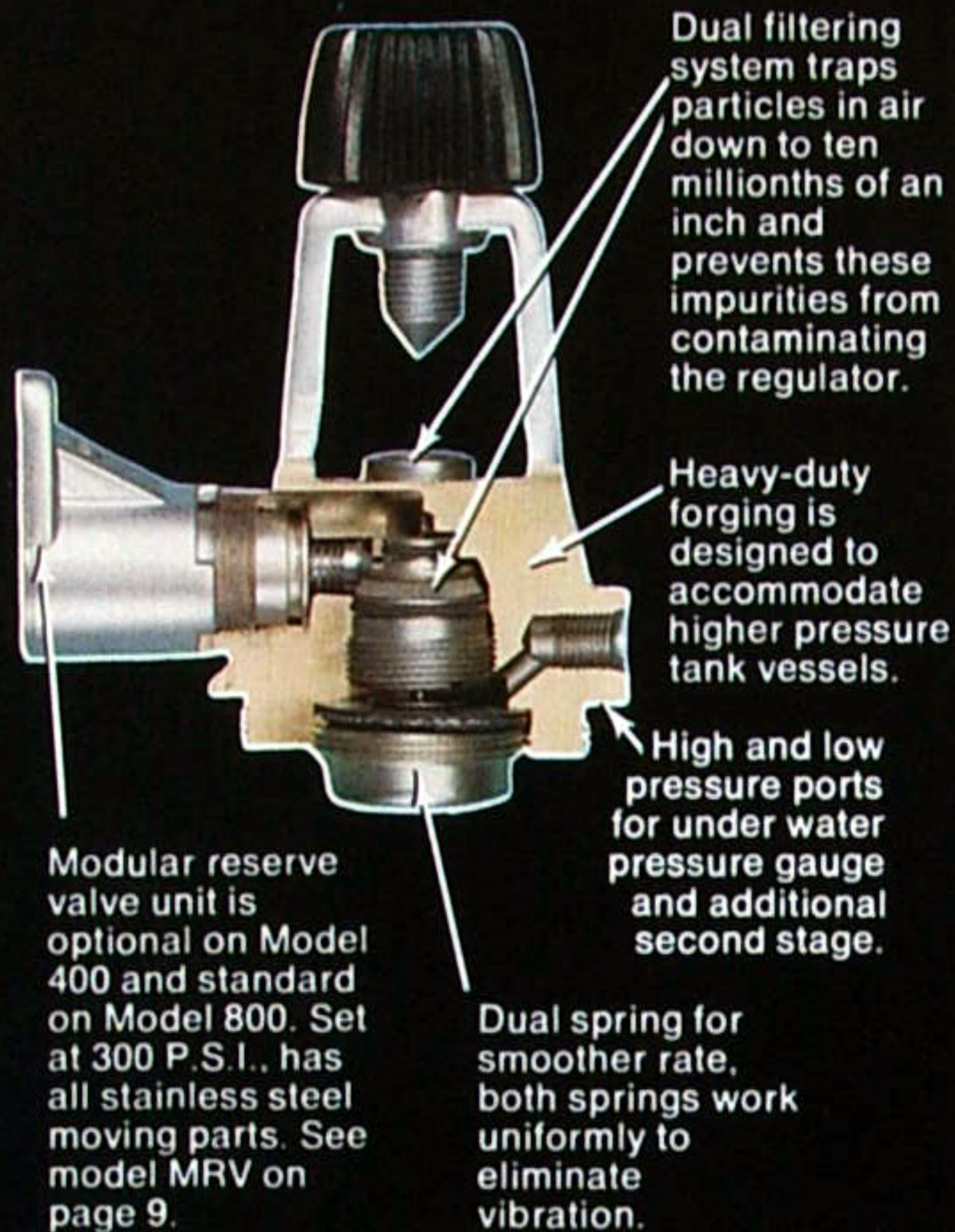

Dual filtering system traps particles in air down to ten millionths of an inch and prevents these impurities from contaminating the regulator.

Heavy-duty forging is designed to accommodate higher pressure tank vessels.

High and low pressure ports for under water pressure gauge and additional second stage.

Dual spring for smoother rate, both springs work uniformly to eliminate vibration.

Modular reserve valve unit is optional on Model 400 and standard on Model 800. Set at 300 P.S.I., has all stainless steel moving parts. See model MRV on page 9.

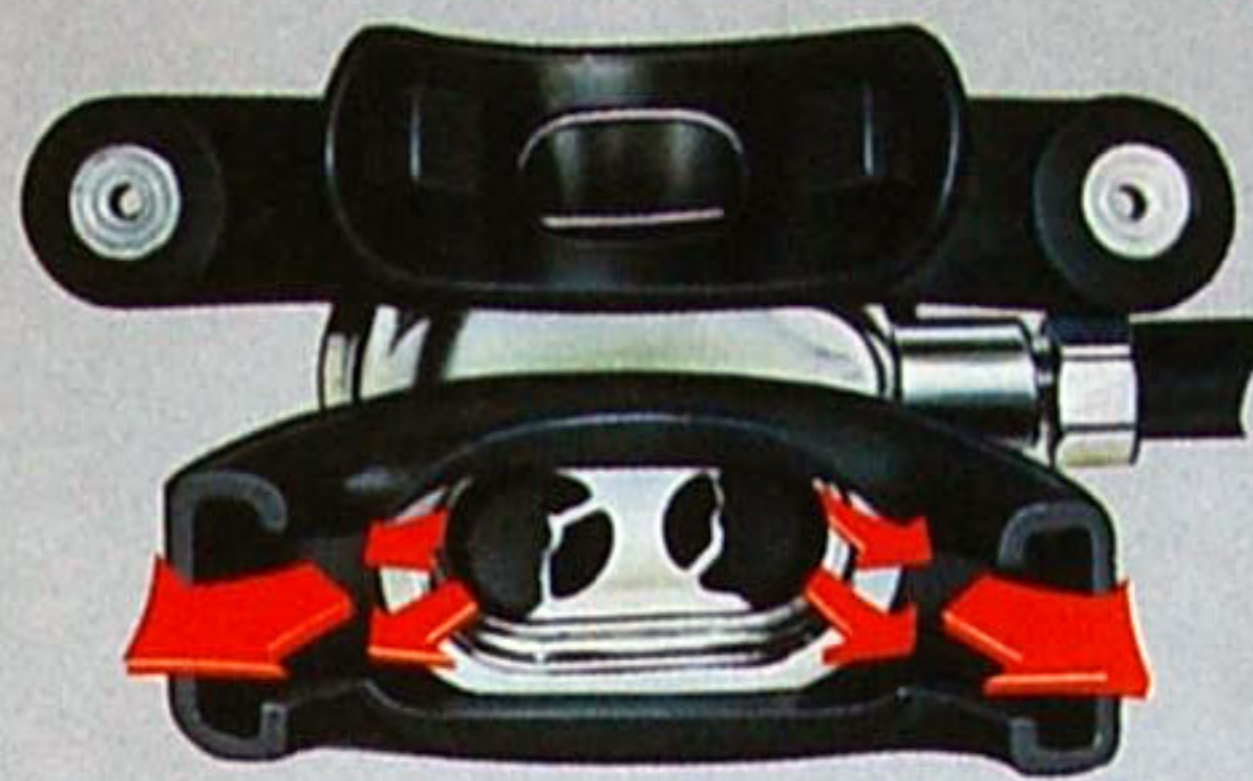

Unique Dual Exhaust Valve System

Dacor was the first manufacturer to recognize the importance of exhalation resistance as a major cause of divers' fatigue when we first introduced the Olympic line four years ago and featured our unique Dual Exhaust System (Patent Pending). This revolutionary system has been tested and proven to provide less effort in exhalation than any single exhaust valve system on the market today, regardless of size. In addition to easier exhaling, our dual system is 50% easier to purge.

The most advanced regulator system on the market today

The acceptance and popularity of this most advanced concept in regulators has been overwhelming. Since we introduced the Olympics four years ago, they have been put to every performance test that would be experienced by any diver, and they have always come out on top. Dacor Olympics were tested by instructors and professionals all over the world. They were used under normal and extreme diving conditions in the Atlantic, Pacific, Mediterranean, Caribbean, Black Sea and fresh water lakes and springs in twenty countries. The reports were unanimous—Dacor did it again by developing the "best" in the most important piece of SCUBA equipment of all—the regulator.

Olympic Second Stage

with NEW anti-free flow device (Patent Pending) with 3 second shut-off—

Developed through extensive research by our engineering department, this unique system eliminates free flow when the regulator is removed from the mouth and the second stage is underwater. Free flow occurs in all easy breathing high volume regulators except the new Olympics with this device.

Here's how it works—Free flow is caused by a differential in pressure which opens the second stage valve that allows a steady stream of air to flow from the regulator. Our revolutionary Anti-Free Flow Device prevents this by permitting water to enter the chamber (A) thus raising the diaphragm (B) and shutting off the second stage valve (C). This function is automatic and in actual testing takes a maximum of 3 seconds, thus minimizing wasted air.

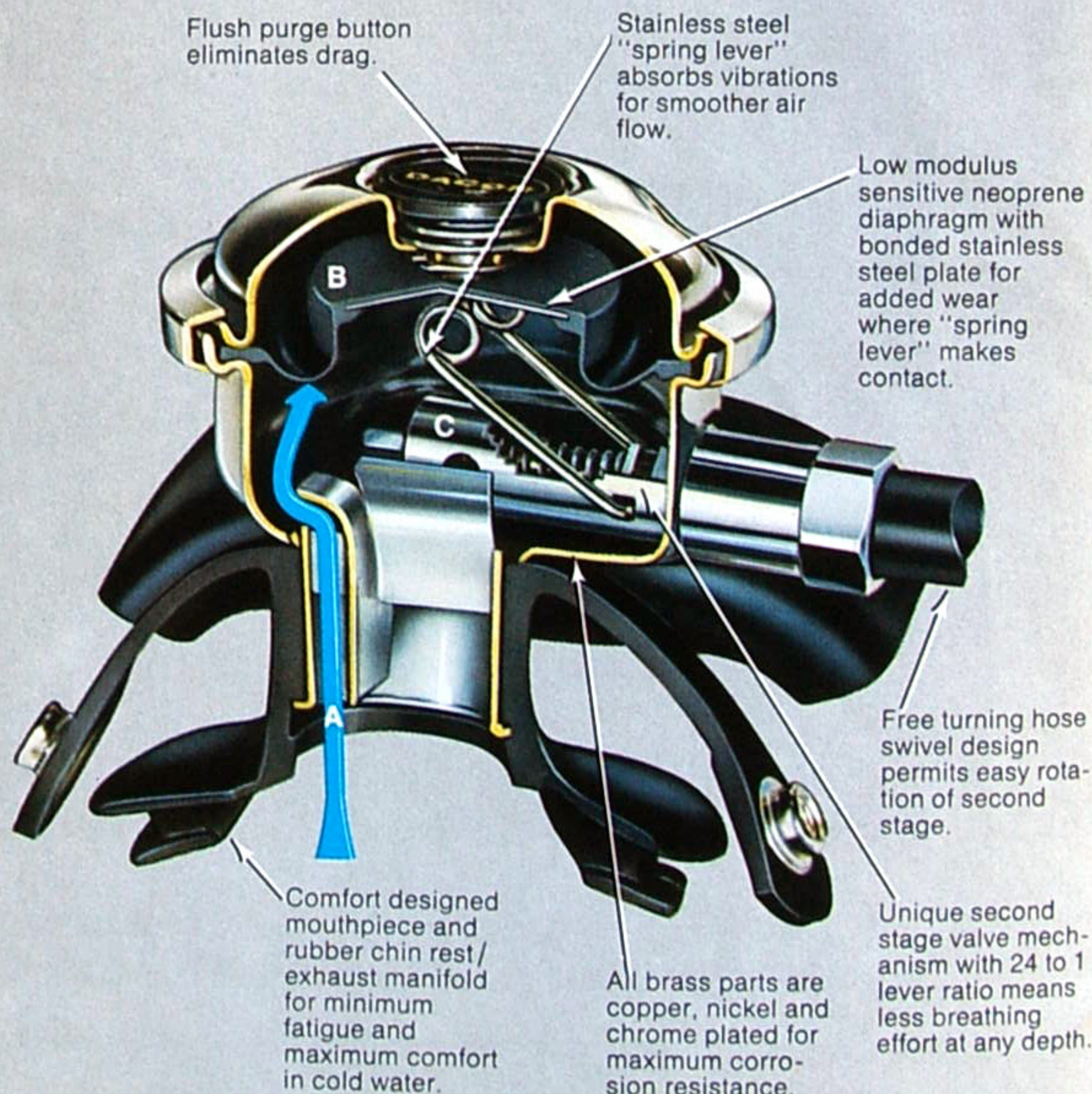

Flush purge button eliminates drag.

Stainless steel "spring lever" absorbs vibrations for smoother air flow.

Low modulus sensitive neoprene diaphragm with bonded stainless steel plate for added wear where "spring lever" makes contact.

Free turning hose swivel design permits easy rotation of second stage.

Unique second stage valve mechanism with 24 to 1 lever ratio means less breathing effort at any depth.

Comfort designed mouthpiece and rubber chin rest/exhaust manifold for minimum fatigue and maximum comfort in cold water.

All brass parts are copper, nickel and chrome plated for maximum corrosion resistance.



Dacor Olympic Regulators

Olympic Model 100

A high performance piston regulator designed for economy, without sacrificing reliability.

- Large piston first stage.
- Teflon seat and back-up rings for maximum sealing.
- High pressure port for underwater pressure gauge.
- Heavy brass chrome nickel plated body, yoke and yoke screw.
- Unique "Dual Exhaust" valve system for minimum exhalation resistance.
- New anti-free flow device with 3 second shut-off.

68.00

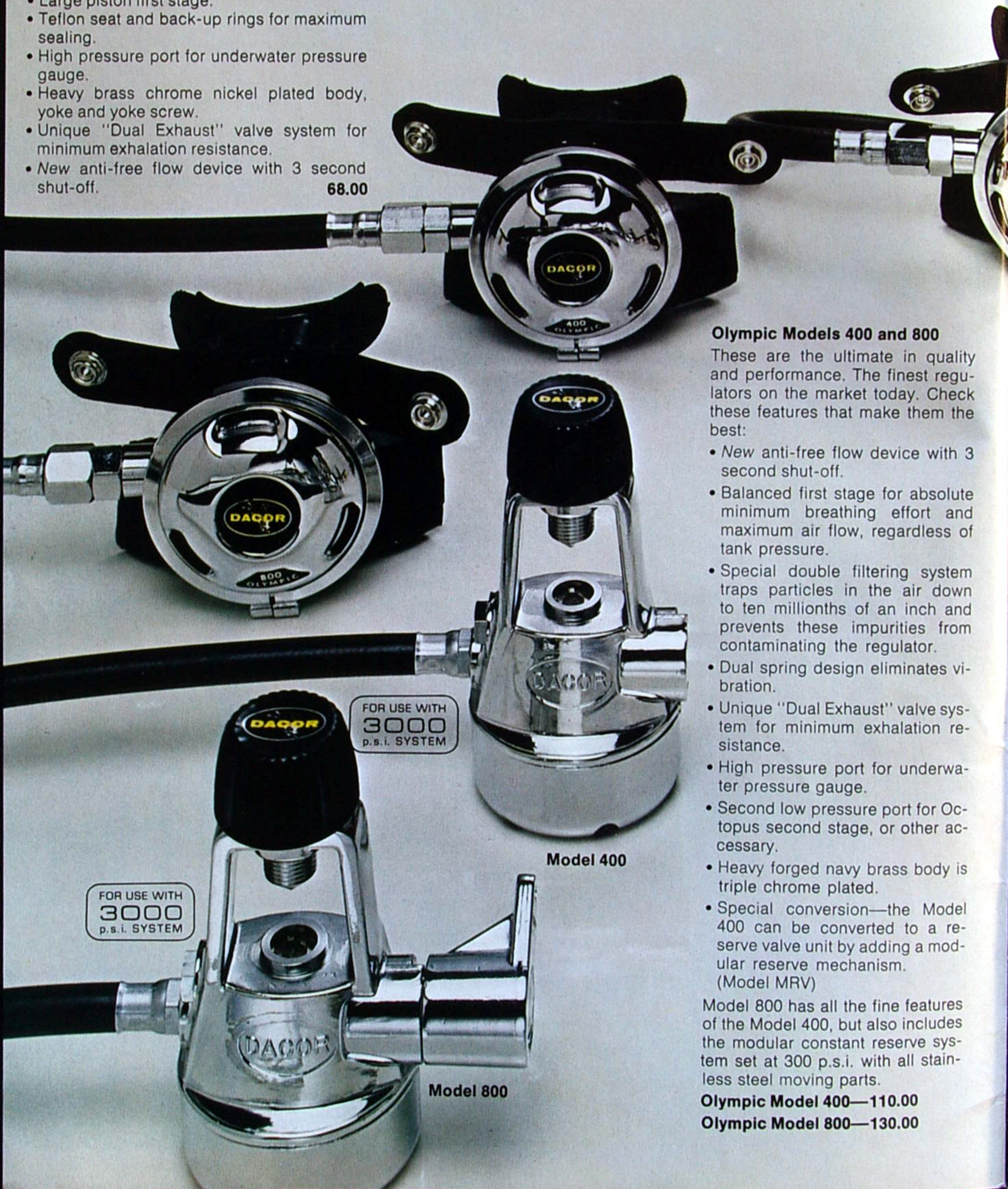

Olympic Models 400 and 800

These are the ultimate in quality and performance. The finest regulators on the market today. Check these features that make them the best:

- New anti-free flow device with 3 second shut-off.
- Balanced first stage for absolute minimum breathing effort and maximum air flow, regardless of tank pressure.
- Special double filtering system traps particles in the air down to ten millionths of an inch and prevents these impurities from contaminating the regulator.
- Dual spring design eliminates vibration.
- Unique "Dual Exhaust" valve system for minimum exhalation resistance.
- High pressure port for underwater pressure gauge.
- Second low pressure port for Octopus second stage, or other accessory.
- Heavy forged navy brass body is triple chrome plated.
- Special conversion—the Model 400 can be converted to a reserve valve unit by adding a modular reserve mechanism. (Model MRV)

Model 800 has all the fine features of the Model 400, but also includes the modular constant reserve system set at 300 p.s.i. with all stainless steel moving parts.

Olympic Model 400—110.00

Olympic Model 800—130.00

Olympic Model 200

This model features the revolutionary "Dual Exhaust" valve system and a machined first stage at a popular price.

- Specially designed first stage diaphragm for extremely fast response.
- Teflon coated high pressure seat for dynamic corrosion resistance and to reduce friction.
- Heavy chrome nickel plated body.
- Dual spring design eliminates vibration.
- High pressure port for underwater pressure gauge.
- Second low pressure port for Octopus second stage, or other accessory.
- New anti-free flow device with 3 second shut-off.

80.00



Model MRV Modular Constant Reserve System

For converting Model 400 into a reserve valve unit. Set at 300 p.s.i. with all stainless steel moving parts (not shown).

22.00

Model 2ST—Second Stage only with Hose

Use where an additional second stage is needed—instruction, cave, wreck and commercial diving. Can be used with Olympic 200, 400 and 800.

50.00



FOR USE WITH
3000
p.s.i. SYSTEM

Model 200

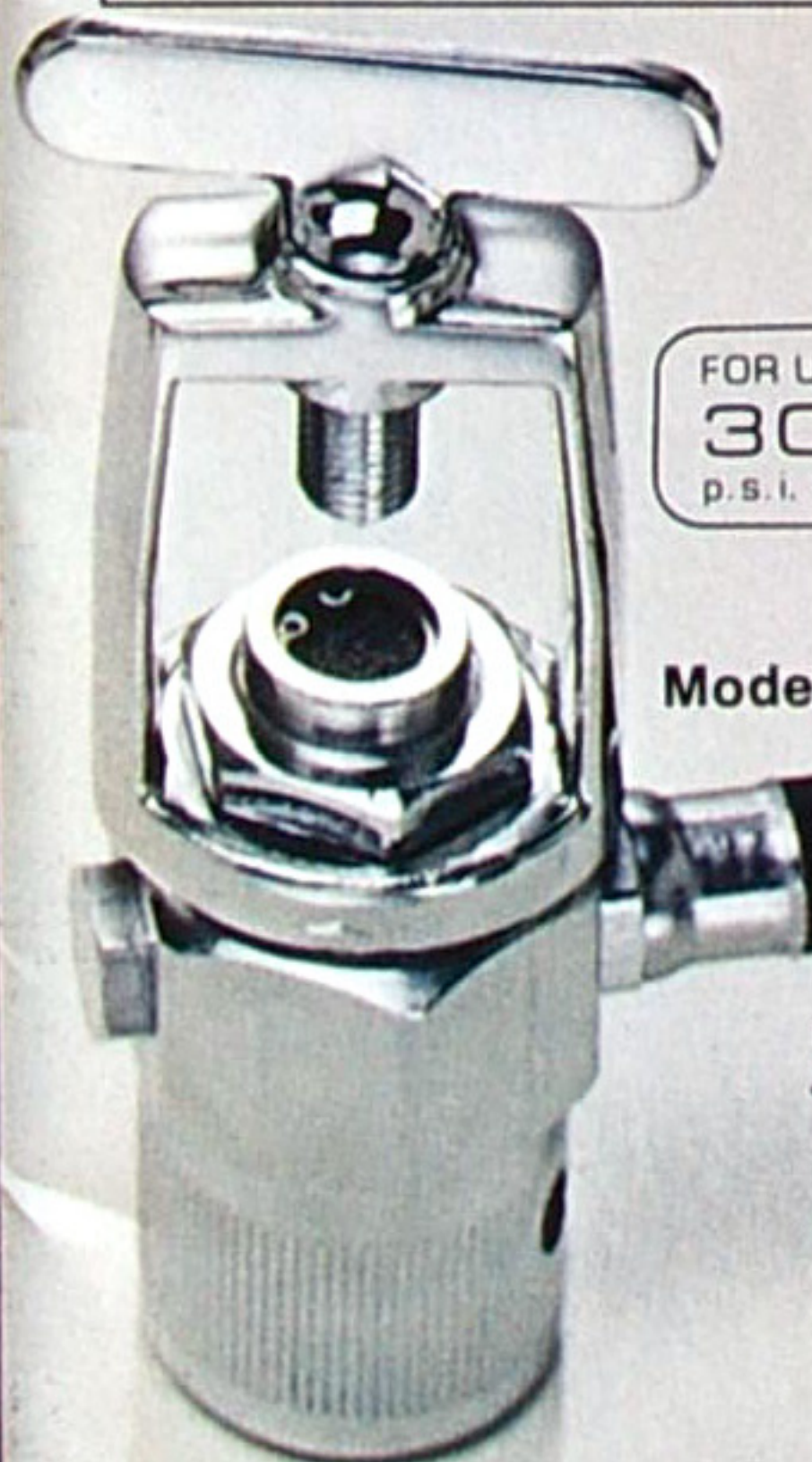

FOR USE WITH
3000
p.s.i. SYSTEM

Model 100

Only Dacor Olympic Regulators Have These Two Exclusive Features:

- Unique Dual Exhaust Valve System
- Anti-Free Flow Device

- Unique "Dual Exhaust" valve system offers 50% less exhalation resistance than single exhaust units. Tests prove that exhalation is more tiring than inhalation. "Dual Exhaust" valves also make it much easier to purge.
- Controlled Venturi for effortless intake at any depth.
- Comfort designed mouthpiece and chin rest to fit all face types.
- Exclusive design brass seat carrier and lever permanently lubricated for reduced friction and uniform air flow.
- Flush purge button.
- Free rotating hose swivel design permits easy rotation of second stage.

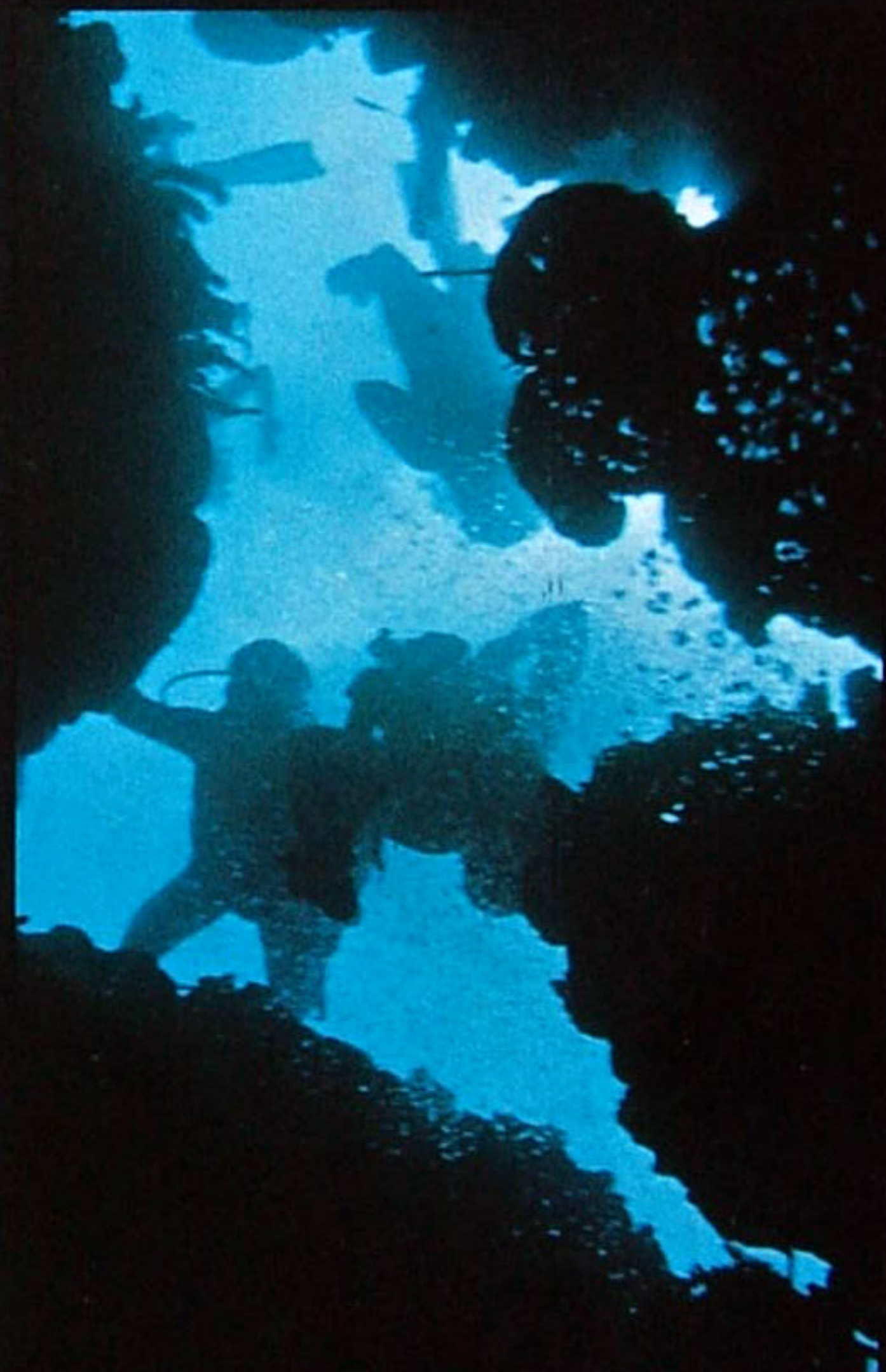

Olympic Octopus

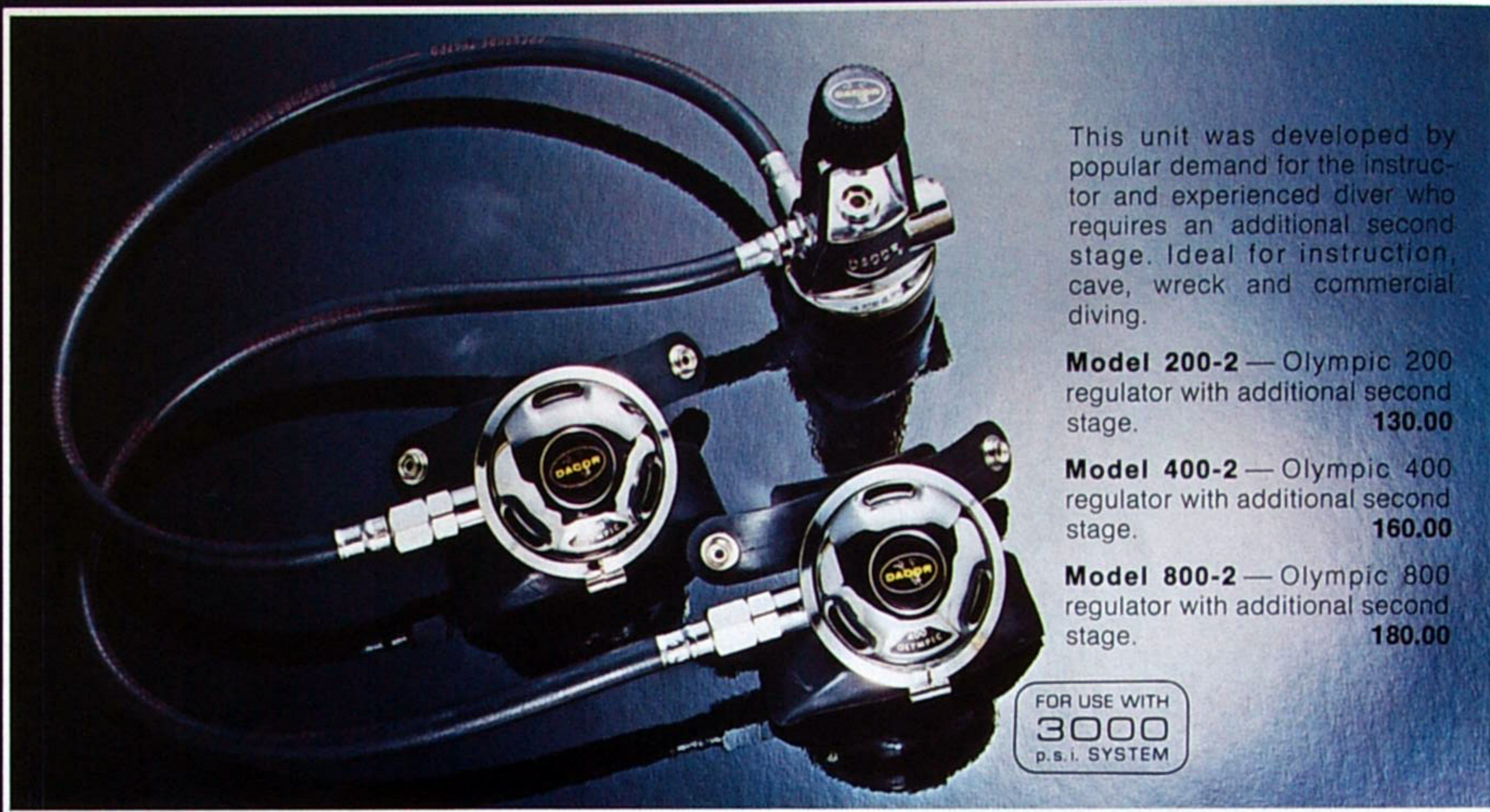

This unit was developed by popular demand for the instructor and experienced diver who requires an additional second stage. Ideal for instruction, cave, wreck and commercial diving.

Model 200-2 — Olympic 200 regulator with additional second stage. **130.00**

Model 400-2 — Olympic 400 regulator with additional second stage. **160.00**

Model 800-2 — Olympic 800 regulator with additional second stage. **180.00**

FOR USE WITH
3000
p.s.i. SYSTEM

Two Hose Regulator



Model C-3N Two Stage Regulator

This professional's choice two stage regulator is capable of delivering over 30 cubic feet of air per minute to the diver. All brass parts are triple-plated chrome, highly polished for lasting beauty and protection. Longer length true spiral hoses for smooth air flow and water purge. Off-set mouthpiece for

comfort and convenience in long working dives. Internal mechanism has teflon coated high pressure seat, free-floating second stage seat, and low modulus diaphragms for low inhalation and exhalation effort. The ultimate for cold water enthusiasts and military and commercial divers. **125.00**

FOR USE WITH
3000
p.s.i. SYSTEM

Dacor Aluminum Tanks



FOR USE WITH
3000
p.s.i. SYSTEM

RUST FREE-CARE FREE

New Dacor 3000 Aluminum Tanks

Rust-free, carefree aluminum (alloy 6351T6) in exciting exclusive metallic colors with durable multiple polyurethane coating. Multi-range filling from 2,250 p.s.i. to 3,000 p.s.i. with capacity to 80 cubic ft. Full 1/2" average wall thickness throughout. Completely new design with overall length and buoyancy characteristics similar to conventional steel cylinders. For use with models QEP, SEP, TEP, TQP, and A2P back packs. (page 22).

LK—Aluminum, Standard Valve. Available in gray, bronze, blue. **161.00**

LR—Aluminum, Reserve Valve. Available in gray, bronze, blue. **177.00**

LR-2—Aluminum Double Tank Block, Reserve Valve. Available in gray, bronze, blue. **354.00**

NEW 50 CUBIC FT. SIZE

Ideal for diver training, smaller divers, or in dual (100 cu. ft.) sets. For use with QEP, SEP, TEP, TQP, and S2P or CDP-2 back packs.

SK—Aluminum, Standard Valve. Available in gray, bronze, blue. **117.00**

SR—Aluminum, Reserve Valve. Available in gray, bronze, blue. **133.00**

SR-2—Aluminum Double Tank Block, Reserve Valve. Available in gray, bronze, blue. For use with S2P or CDP-2 back packs. **266.00**

Alum. tanks avail.
May 15, 1974.

TEN YEAR ALUMINUM CYLINDER WARRANTY

Dacor warrants that all aluminum tanks will pass each required D.O.T. hydrostatic test in the ten year period from the original test date. Replacement will be made at no charge for any tank which fails to pass the test. This warranty does not apply if failure to pass the test is the fault of the user through misuse, mechanical damage or improper care. This warranty is valid only when the registration card is sent to Dacor Corp. within ten (10) days from date of purchase. Tanks claimed to be defective are to be returned to factory, freight prepaid.

Dacor Tanks

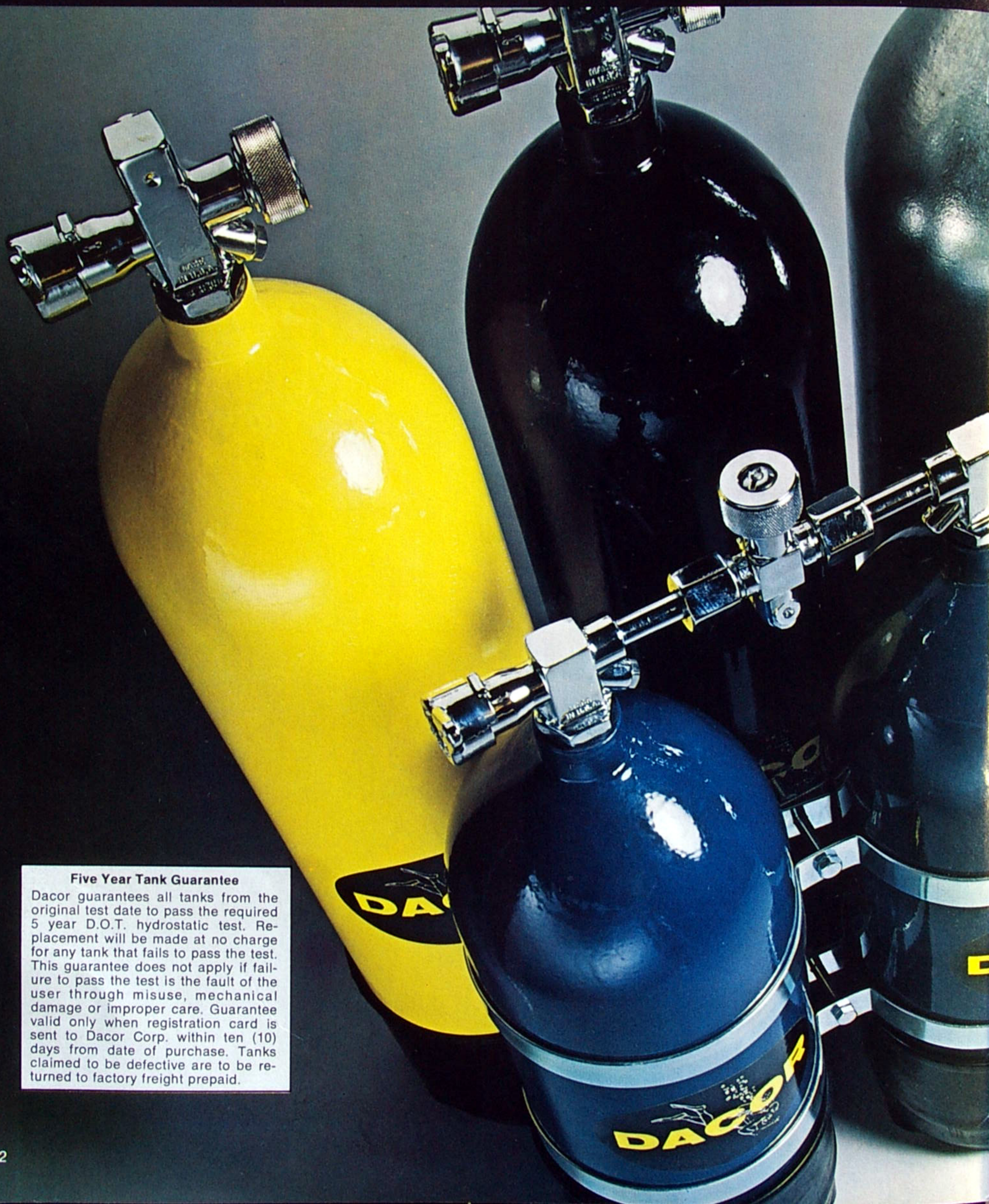

Five Year Tank Guarantee

Dacor guarantees all tanks from the original test date to pass the required 5 year D.O.T. hydrostatic test. Replacement will be made at no charge for any tank that fails to pass the test. This guarantee does not apply if failure to pass the test is the fault of the user through misuse, mechanical damage or improper care. Guarantee valid only when registration card is sent to Dacor Corp. within ten (10) days from date of purchase. Tanks claimed to be defective are to be returned to factory freight prepaid.



Steel 71.2 cu. ft. Tanks

Galvanized Models

UG—Bare	96.00
UKG—Standard Valve	117.00
URG—Reserve Valve	132.00
URG-2—Double Tank Block, Reserve Valve.	264.00

Colorful Thermo-Coat Models

UY—Bare, yellow	104.00
UU—Bare, blue	104.00
UK—Bare, black	104.00
UKY—Standard Valve, yellow	125.00
UKU—Standard Valve, blue	125.00
UKK—Standard Valve, black	125.00
URY—Reserve Valve, yellow	140.00
URU—Reserve Valve, blue	140.00
URK—Reserve Valve, black	140.00
URY-2—Double Tank Block, Reserve Valve, yellow.	280.00
URU-2—Double Tank Block, Reserve Valve, blue.	280.00
URK-2—Double Tank Block, Reserve Valve, black.	280.00

Steel 50 cu. ft. Tanks

Galvanized Models

MG—Bare	92.00
MKG—Standard Valve	113.00
MRG—Reserve Valve	128.00
MRG-2—Double Tank Block, Reserve Valve.	258.00

Colorful Thermo-Coat Models

MU—Bare, blue	100.00
MKU—Standard Valve, blue	121.00
MRU—Reserve Valve, blue.	136.00
MRU-2—Double Tank Block, Reserve Valve, blue.	274.00

Dacor recommends a yearly internal inspection of your diving cylinder. See your local Dacor dealer for this service.



These Chrome Molybdenum steel tanks are safety tested at over twice normal pressure. Designed to float when empty. All tanks have 3/4" "O" ring seal for positive air retention.

2 Way Protection

1. Galvanized Under-Coating

All Thermo-Coat tanks have the same layer of protection as the regular galvanized tanks; a triple dip of zinc galvanizing.

2. Colorful Thermo-Coat

Exclusive fluidized bed process fuses color coating to tank. Finish is bonded to tank at 450 degrees. Color up your diving... choose this special finish. Available in the following colors: (71.2 Cu. ft. size)—Blue, yellow, black. (50 Cu. ft. size)—Blue only.

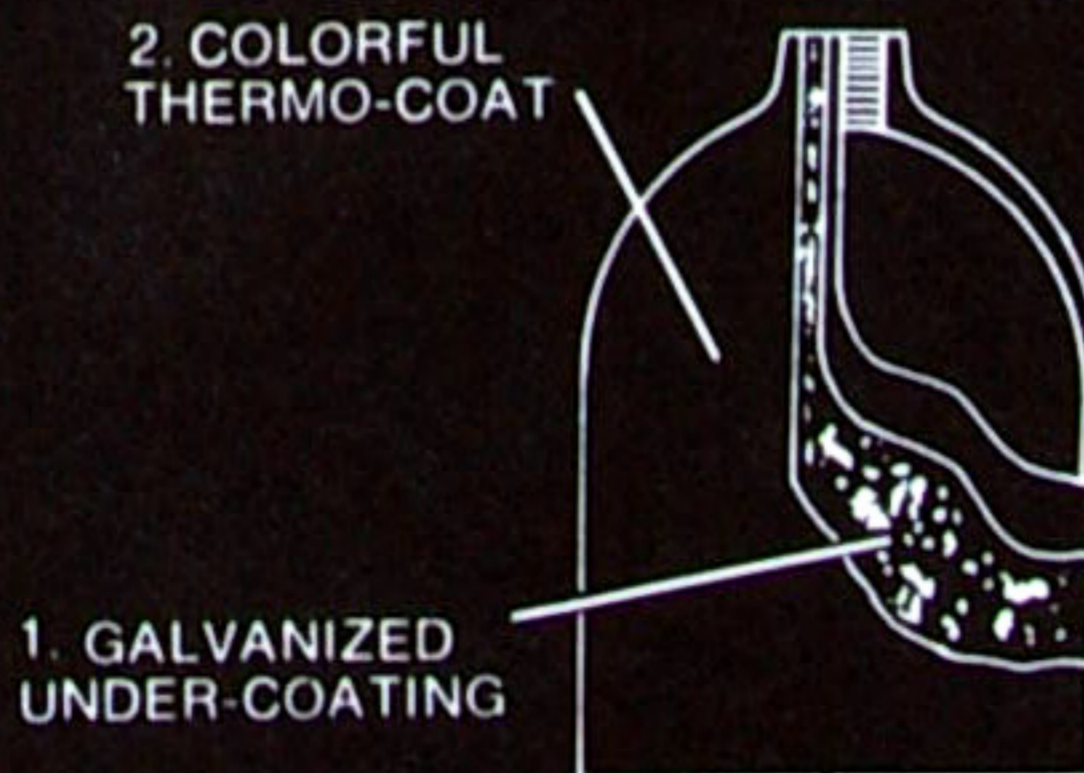

Dacor Corda Fins

... the only way to go

There are many kinds of fins on the market today ... all shapes and sizes, but none compare to the Dacor CORDA and TURBO Fins.

Dacor designed the CORDA Fin many years ago and it became the standard of the industry. The CORDA provides power, strength and superior propelling design. Because Dacor has an unrelenting research and development program, the people at Dacor recognized a more "active" diver coming on the scene. Instead of just diving and sightseeing, the new divers were interested in spearfishing, wreckdiving, salvaging and photography. These divers wanted more POWER with minimum exertion. For these advanced and active divers, Dacor developed the TURBO Fins. Whichever Dacor fin you choose, you can have confidence that it's the finest of its type available today.

Corda Fins

Longer blades and heavier side rails now deliver astonishing speed and power! Finest quality rubber, designed for untiring use, ideally balanced for maximum efficiency. Comfortable full foot design provides protection against rock and coral. Sizes 1-15 in Black (non floating) and Blue (floating).

Corda Fins (Black—Non-Floating)

C1-2K	Corda— Size 1-2	9.95
C2-3K	Corda— Size 2-3	10.95
C4-5K	Corda— Size 4-5	11.95
C6-7K	Corda— Size 6-7	12.95
C7-8K	Corda— Size 7-8	13.95
C9-10K	Corda— Size 9-10	14.95
C11-12K	Corda— Size 11-12	14.95
C13-15K	Corda— Size 13-15	15.95

Corda Fins (Blue—Floating)

C1-2U	Corda— Size 1-2	10.95	C7-8U	Corda— Size 7-8	14.95
C2-3U	Corda— Size 2-3	11.95	C9-10U	Corda— Size 9-10	15.95
C4-5U	Corda— Size 4-5	12.95	C11-12U	Corda— Size 11-12	15.95
C6-7U	Corda— Size 6-7	13.95	C13-15U	Corda— Size 13-15	16.95



Turbo Fins

Turbo Fins—Power When You Need It

At last, a scientific breakthrough in fin design that allows every square inch of the fin surface to propel you underwater. You control the propulsion with this fin. Kick easy and you glide; kick hard and you have POWER . . . WHEN YOU NEED IT. Turbo fins are a product of 20 years of research and experience in underwater design and manufacture. Available in large and medium in black (non floating) and blue (floating).

- DT-K**—Large Black, Sizes 8 and up. **22.00**
- MT-K**—Medium, Black, Sizes 4 to 8. **18.00**
- DT-U**—Large Blue, Sizes 8 and up. **23.00**
- MT-U**—Medium, Blue, Sizes 4 to 8. **19.00**

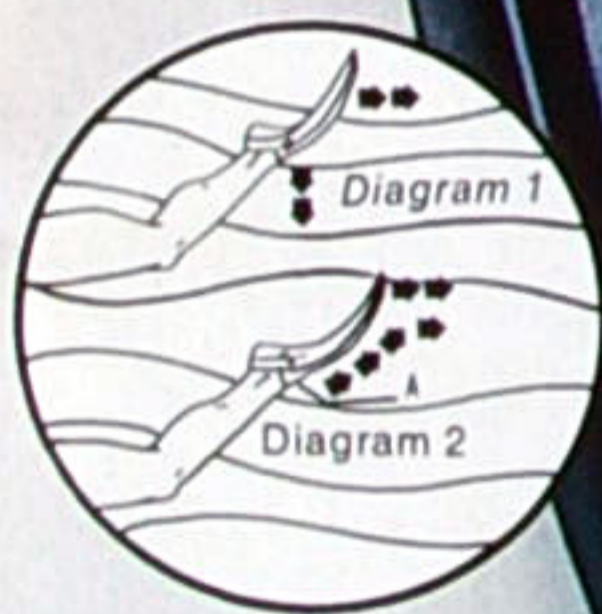

Turbo Action

Diagram 1—This area of the blade provides the pushing action in direction of the arrows. It was previously thought that area A was a negative dead area because of the downward thrust of the fin. However . . . due to slow motion film studies, it was found that the water at point A (*Diagram 2*) is channeled along the blade and out back of the fin, resulting in complete rearward thrust due to the forward motion of the diver.



Dive Shoes

The perfect solution for shore entries and exits. Hard non-slip sole protects and gives additional support. Perfect for use with larger fins.

DB Sizes 7, 8, 9, 10, 11
5.95

Dacor Turbo II Fins

New Quadra-Vent Design

A new vented fin featuring the proven design of the Turbo Fin combined with the easy action flow-through principal so popular today. The Turbo II with Quadra-Vent propulsion channels the water through and across the blade surface providing the lowest energy to propulsion ratio. The diver has greater vertical and lateral stability control because of the evenly distributed flow that the Quadra-Vent design provides. Available in black only.

TV-K—Large Black, Sizes 8 and up. **22.00**



Dacor Masks



DM18K Tenue (Black)

Our deluxe mask for the diver who wants the best. Maximum leakproof double feather edge is contoured to fit the face perfectly. Minimum air volume between diver's face and lens, easy to equalize. **14.95**



DM23K Nautilus (Black)

Our newest mask with the best combination of both peripheral and downward vision. Contoured double feather edge seal for comfortable good fit. **14.95**



DM27K Equinaut (Black)

Maximum panoramic field of vision. Specially designed to minimize air space. Double feather edge seal. **13.95**



DM28K Professional (Black)

This popular type professional mask has excellent peripheral vision and minimum air space. Heavy duty construction with extra large purge valve. **12.95**

Dacor is now manufacturing 16 masks of unequalled quality and design. Although each one has different features for equalizing, purging, sealing, peripheral vision and comfort, they were all developed to meet the highest standards and requirements of the most advanced divers. We found that the mask is one piece of gear for which the diver likes to express a very personal preference. That is why Dacor has developed such an extensive line—there is one mask shown on these pages that is "best" for you. We advise the beginning diver to consult a qualified instructor or pro dive shop to find out which Dacor mask is best for him. If you choose your mask from these pages, you'll know you have the "best."



Your Window To Another World

Dacor Masks All Have These Quality Features.

Rugged split mask strap prevents slipping and insures proper fit.

Feather edge face seal design for no-leak fit and long wearing comfort.

Tempered glass face plate.

Triple chrome plated brass buckles with locking slide bar for quick, easy and positive strap adjustment.

Stainless steel rim.

All rubber is specially compounded with inhibitors to resist sun, salt, chlorine and ozone for longer wear.



Model AG Olympic Goggles
 Latest racing design. Foam neoprene seals protect against chlorine. Flat acrylic lenses with non-glare smoke tint. Adjustable head and nose straps. **3.70**



A



B



E

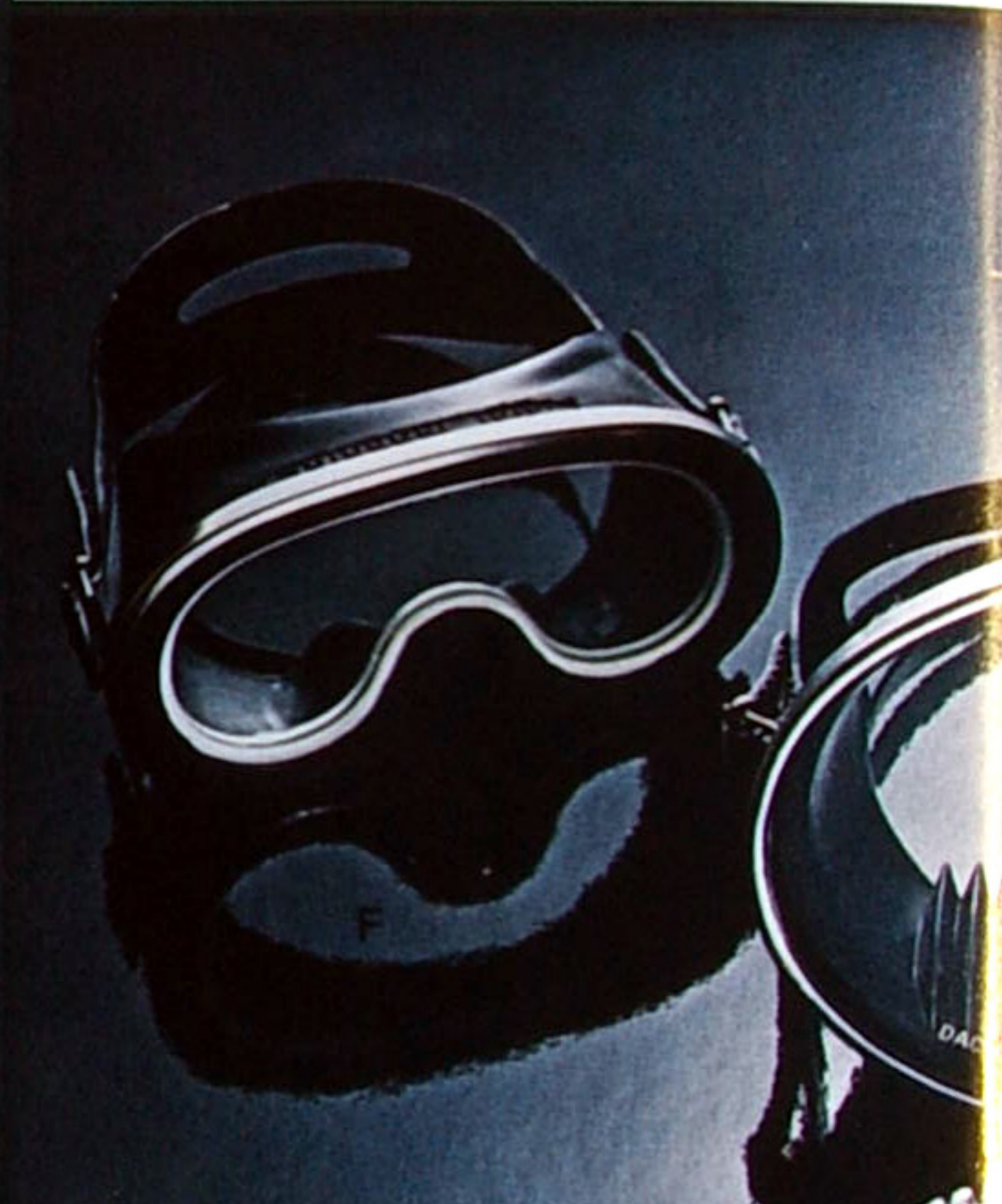

F



J



K



C



D



H

G



I



L



M

**A DM10K Universal (Black)
DM10U Universal (Blue)**

DACOR'S most popular mask features slanted design for greater visibility. The finest sealing mask in the world. **7.95**

B DM12K Triton (Black)

Straight upward movement makes for easier equalizing. Patented separated nostril pads close nostrils without interfering with web between nostrils. Features purge valve. **9.95**

C DM14K See Rite (Black)

20% more side visibility with this specially designed mask for wider faces. Purge valve. **8.95**

D DM15K See Rite (Black)

Same as DM-14 but without purge valve. **7.95**

E DM19K New Vedo (Black)

Mask is specifically designed for your own prescription lenses. Rubber inserts hold lenses and insure water tight seal. **14.95**

F DM22K Mini-Mondial (Black)

Same as Tenue DM-18 but 20% smaller in size. **9.95**

G DM24K Mini-Pro (Black)

At last, a mask for the smaller face. All of DACOR'S finest features including easy equalization finger wells. Ideal for women and younger divers. **9.95**

DM25K Mini-Pro (Black)

Same as Model DM-24 but without purge. (not shown) **8.95**

H DM26K Mini-Universal (Black)

DM26U Mini-Universal (Blue)

For smaller faces. Modeled exactly after our famous DM-10 UNIVERSAL, but 20% smaller. **6.50**

I DM29K Mini-Equalizer (Black)

For smaller faces. Modeled exactly after our famous DM-31 equalizer, but 20% smaller. **6.95**

J DM30K Equalizer (Black)

DM30U Equalizer (Blue)

Features the soft, excellent sealing qualities and comfort of our famous DM-10, but has finger wells for easy equalization. Purge valve. **9.95**

K DM31K Equalizer (Black)

Same as DM-30 but without purge valve. **8.95**

L DG Swim Goggles

Championship type. Soft double feather edge for leak-proof seal. Tempered lens. Close to face design to eliminate drag. **5.00**

M SG Round "Ocuplane" Goggles

New design provides comfortable fit and conforms to facial contour for positive seal. Flat visual plane with tempered glass for distortion-free vision. **6.00**

Dacor Snorkels

Dacor—First with the "Glo Top,"®
First with the Big Barrel Wrap Around,
First with the professionals

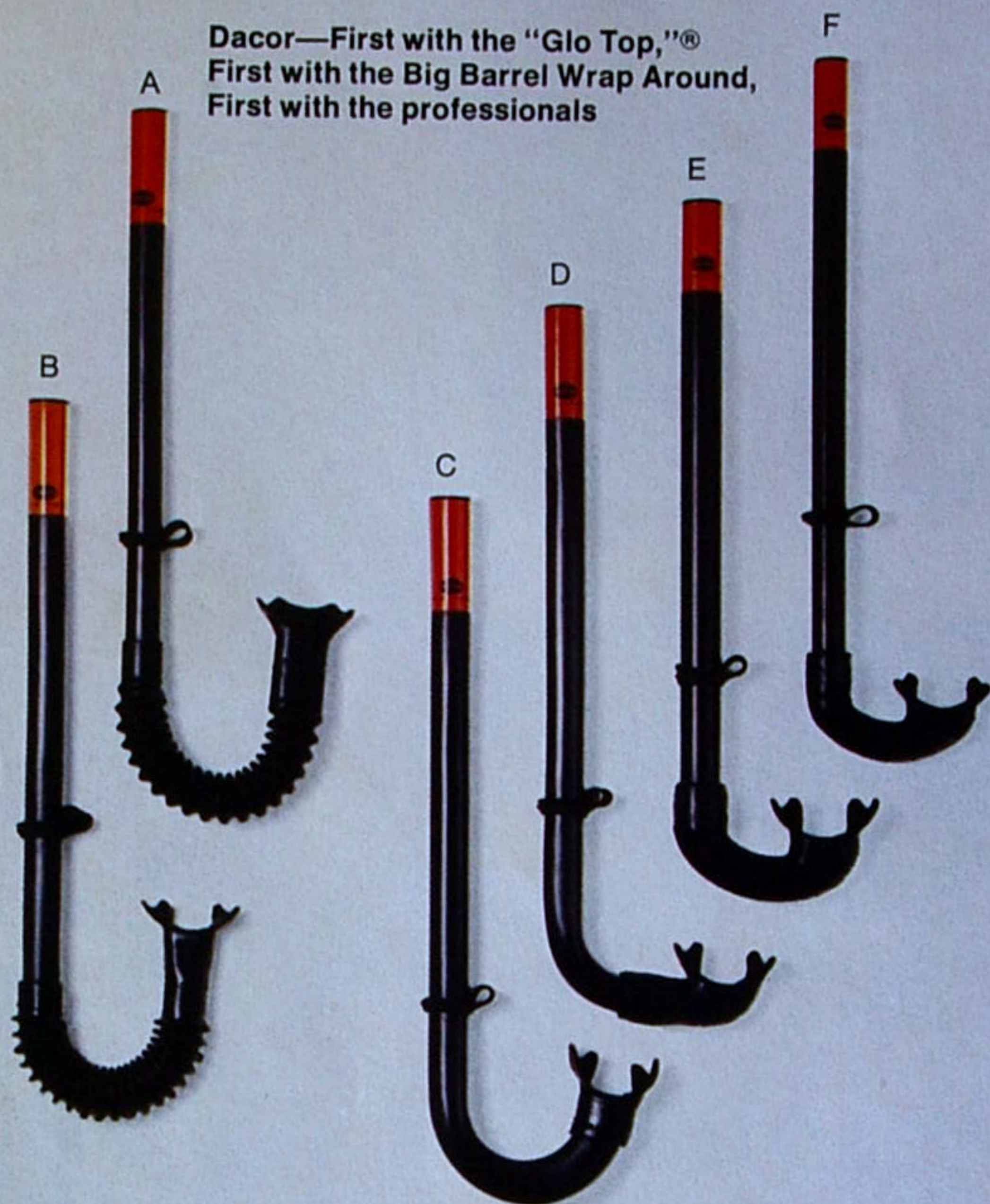

Scientifically Designed for Maximum Performance

Dacor All Rubber Snorkels—

Long wearing black rubber compounded to resist sun, salt and ozone. Comfortable, odorless and tasteless mouthpiece. Original orange "Glo-Top"®—not a paper decal—but a special flexible plastic that actually reflects light. It's iridescent!

A FST—Spiral-Flex "Glo-Top"® Snorkel—

Flexible spiral hose bends to any shape or angle, spins water out, won't crimp or shut off air. **3.95**

B RST—Flexible "Glo-Top"® Snorkel—

Comfortable lug type mouthpiece with non-crimping hose molded as one part. **3.95**

C UST—Universal "Glo-Top"® Snorkel—

This most popular type snorkel delivers maximum air volume under all conditions. The universal favorite of divers the world over. Comfortable lug type mouthpiece. **3.25**

D LST—"L" Shaped "Glo-Top"® Snorkel

New design minimizes drag by reducing tubing below head level. Comfortable lug type mouthpiece. **3.25**

E EST—Standard "Glo-Top"® Snorkel—

A standard size snorkel with lug type rubber mouthpiece and plastic barrel. **2.75**

F PSTK—Lightweight (Black) PSTY—Lightweight (Yellow) "Glo-Top"® Snorkel—

Here's an economical snorkel designed for easier breathing with a lug type rubber mouthpiece and plastic tube. **1.95**

Turbo "Glo-Top"® Snorkels—
New, professional, all rubber snorkels for the diver who demands these high performance benefits — greater air volume, easier exhalation and maximum comfort. Large diameter, flexible barrel that is easier to clear. Specially designed custom contoured mouthpiece means less mouth fatigue even for extended periods of free diving. Ideally suited for new displacement clearing method.

**Model TBT—Turbo
Contour Tube** **5.00**

**Model TST—Turbo
Standard Tube** **5.00**



TBT

There Is A Difference in Snorkels— These Three “Pro” models Prove It



GST—The Original Big-Barrel Wrap-Around “Glo-Top”® Snorkel—

This major improvement in snorkel concept and design has been often copied but never equalled. Only Dacor's Big-Barrel is the one for you—the one with a little different twist that makes the difference. Made especially for the expert skin diver who needs that extra volume for deeper dives. “WrapAround” design fits contour of head and minimizes water resistance while diving. Extra large diameter barrel allows easier volume intake, yet it is exceptionally easy to clear. Short length minimizes CO₂ build up and eliminates drag in water. High impact clear plastic construction, molded rubber lug-type mouthpiece.

5.00

The diver depends on the snorkel as a basic piece of equipment. He uses it for skin diving and spear fishing. With SCUBA, the diver uses it to swim on the surface and observe as he conserves air, or he may use it as a safety device to prevent exhaustion when swimming for the boat if he's out of air.

While many manufacturers have treated it merely as a hollow tube, Dacor has developed its snorkel line from years of experience and scientific research.

There's the important comfort feature for which Dacor has designed different mouthpieces to give the diver a choice. Dacor has developed snorkels with different air volumes that directly affect ease of breathing. Of course, the “Glo Top” feature was another safety “first” for Dacor.

Our company has traditionally been the leader in snorkels, which was proven when Dacor led the industry by developing the first Big Barrel Wrap – Around model. Others have tried to duplicate these Dacor snorkels, but they have not improved or even equalled them. You can use your Dacor snorkel with confidence that it is the “best.”



Back Packs

**A Model TQP—
Deluxe Plastic Pak**

A strong new compact back pak with rubber lined stainless steel band, quick release cam, three molded-in handles with finger grip design, and nylon harness with stainless steel Quick-ditch buckles on waist and left shoulder. Fits steel and aluminum tanks. Dealer installed conversion kits allow use with double tanks. Black only. **28.50**

**Model TEP—
Standard Plastic Pak**

Same as TQP but without quick release cam. Black only. (not shown) **22.00**

**B Model QEP—
Deluxe Aluminum Pak**

Adjustable two inch rubber lined stainless steel band allows use on both steel and aluminum tanks. New "flip-over" ring adjusting screw for fit and comfort. Self locking over center cam for quick tank change. Large handle for easy carrying. Quick-Ditch buckle at waist and on left shoulder. Harness is 2" high tensile strength nylon webbing. Plate is formed of heavy gauge marine aluminum with exclusive Thermo-Coat finish. Black only. **30.00**

**Model SEP—
Standard Aluminum Pak**

Same as QEP but without handle and quick release cam. Black only. (not shown) **23.00**

**C Model S2P—
Plastic Double Tank Pak**

Similar to TEP but with heavy gauge dual bands of zinc plated steel with black Thermo-Coat. Fits steel tanks and 6.9" diam. 50 cu. ft. alum. tanks. **36.00**

**Model A2P—
Plastic Double Tank Pak**

Same as S2P but bands designed to fit 7.25" diam. aluminum tanks. (not shown) **36.00**

**Model CDP-2
Aluminum Double Tank Pak**

Similar to SEP but with heavy gauge dual bands of zinc plated steel and triple snaps on left shoulder harness. Fits steel tanks and 6.9" diam. 50 cu. ft. alum. tanks. (not shown) **33.00**



New Feature

Stainless Steel adjusting screw with convenient "flip over" ring for flush fit and maximum comfort.



D

D Model PTB—Plastic Tank Boot

New economical all plastic boot supports tank in upright position, protects tank and prevents damage to pool tile and other surfaces. Available in black and yellow. **3.95**

E Model TB—Rubber Tank Boot

Supports tank in upright position, protects tank and eliminates damage to pool tile and other surfaces. Made of sun and salt resistant non-marking rubber. Black only. **7.00**

F Model ATB—Vinyl Tank Boot

Soft Plastisol vinyl fits 7.25" diam. 3,000 p.s.i. aluminum tanks. Boot will not get hard in cold water or weather, is non-marking and has self-draining bottom portion. Excellent for pool use. Black only. **6.50**



Tank Boots

Dacor Valves

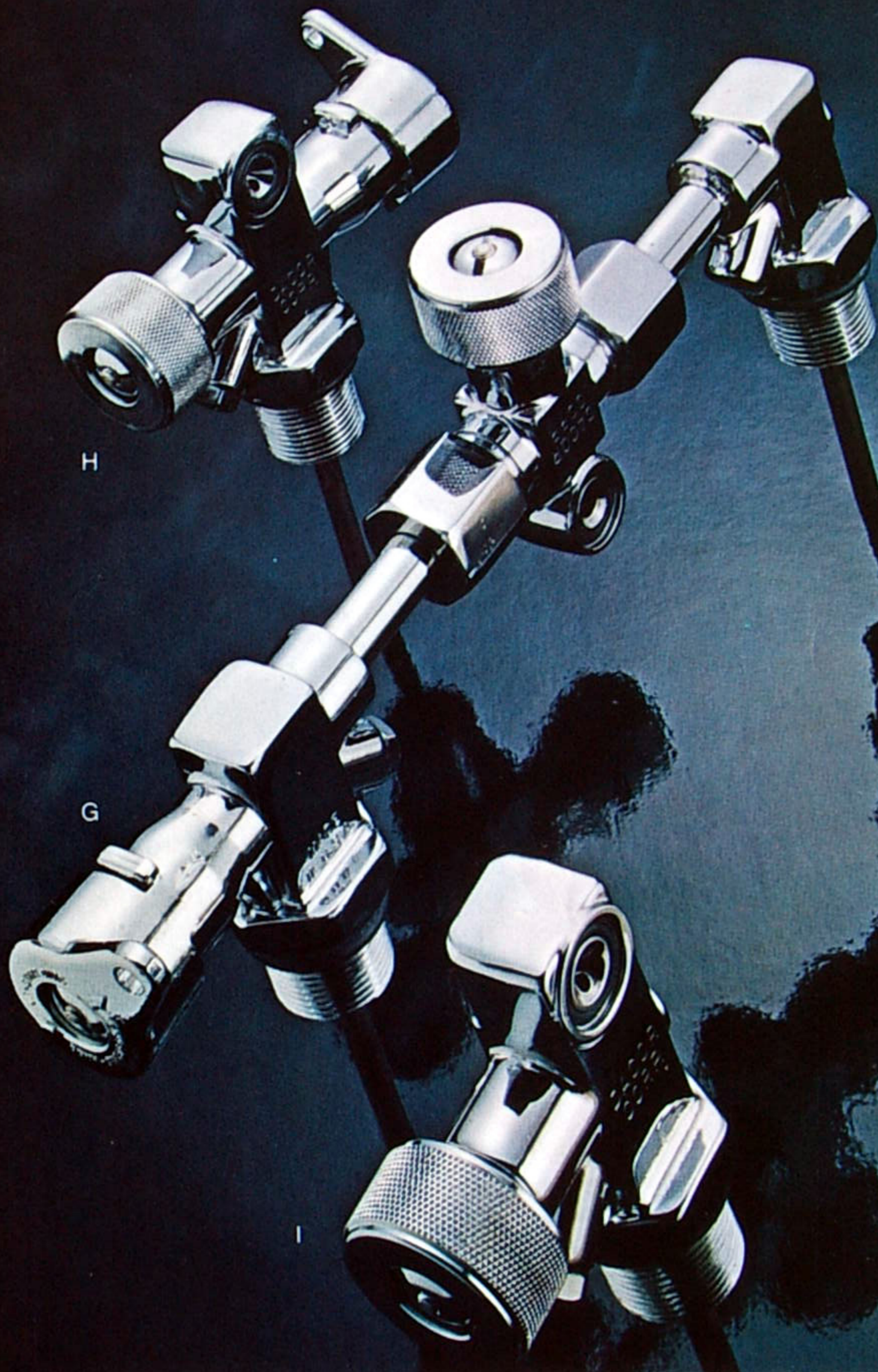

All Dacor Tank Valves Have These Quality Features

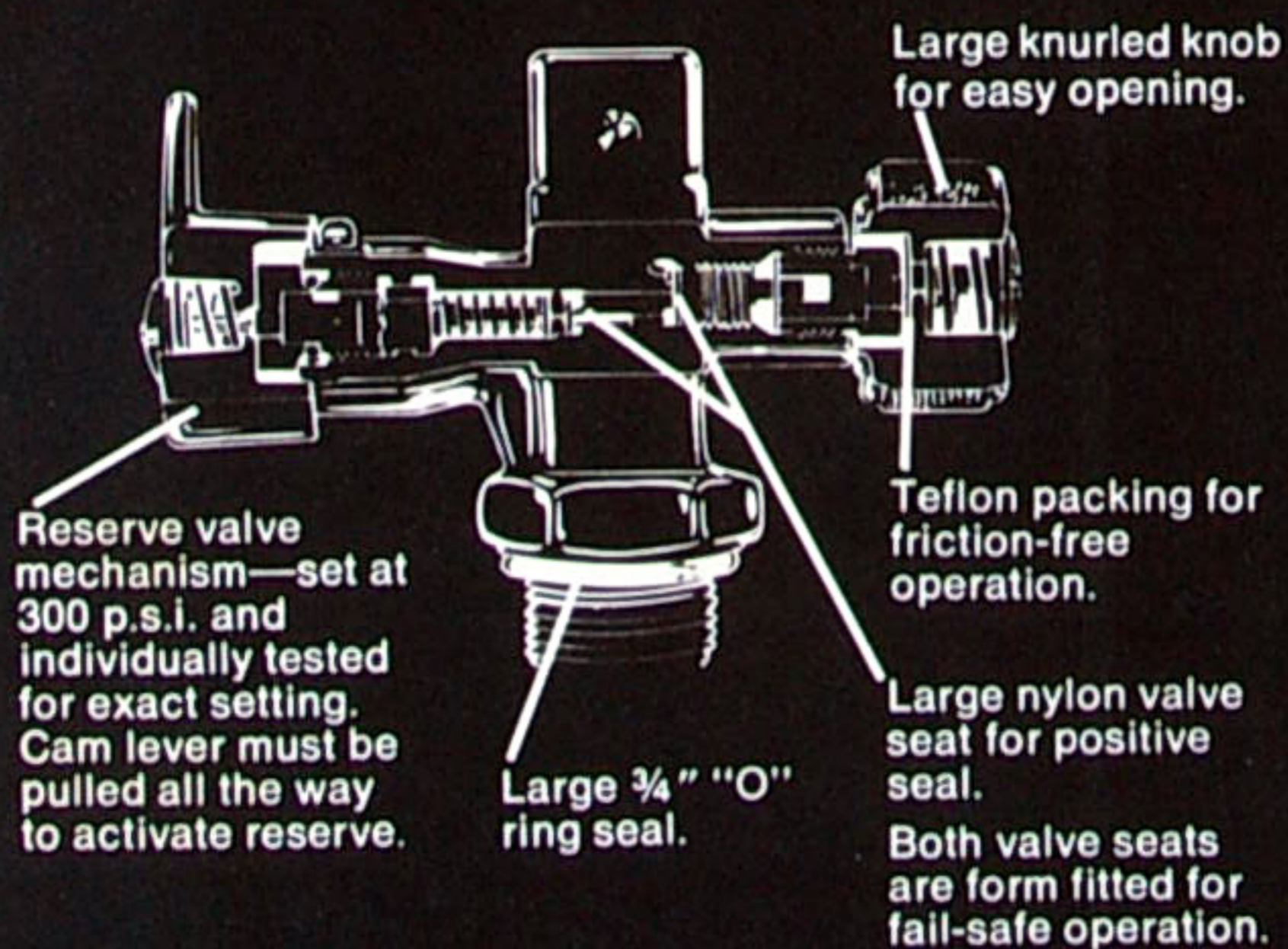

G Model JV-2 Double Tank Valve

Connects two tanks for twin operation. Spring-loaded reserve type, of heavy brass, chrome plated for longer life. Rugged center section withstands severe stresses; large knurled knob for easy opening. 3/4" "O" ring seal. Reserve set for 500 p.s.i. **79.00**

I Model KV 3/4 Valve

3/4" "O" ring seal standard "K" valve made of heavy forged brass with copper, nickel and bright chrome finish. Large knurled knob is easy to open with gloved hands. **29.00**

H Model JV 3/4 Valve

3/4" "O" ring seal, spring-loaded reserve valve in bright chrome finish.

Easy-to-use large knurled on-off knob. 300 p.s.i. reserve is fool-proof and reliable; design is simplified for accuracy and service free operation. **47.50**

Model JV 1/2 Valve

For 1/2" pipe thread tanks. Spring-loaded reserve valve in bright chrome finish. 300 p.s.i. reserve. (not shown) **48.50**

FOR 3,000 P.S.I. SYSTEM:

Model K3V Standard Valve **29.00**

Model J3V Reserve Valve **47.50**

Model J3V-2 Double Tank Reserve Valve **79.00**

All above have 4800 p.s.i. safety disc.

Dacor Depth Gauges

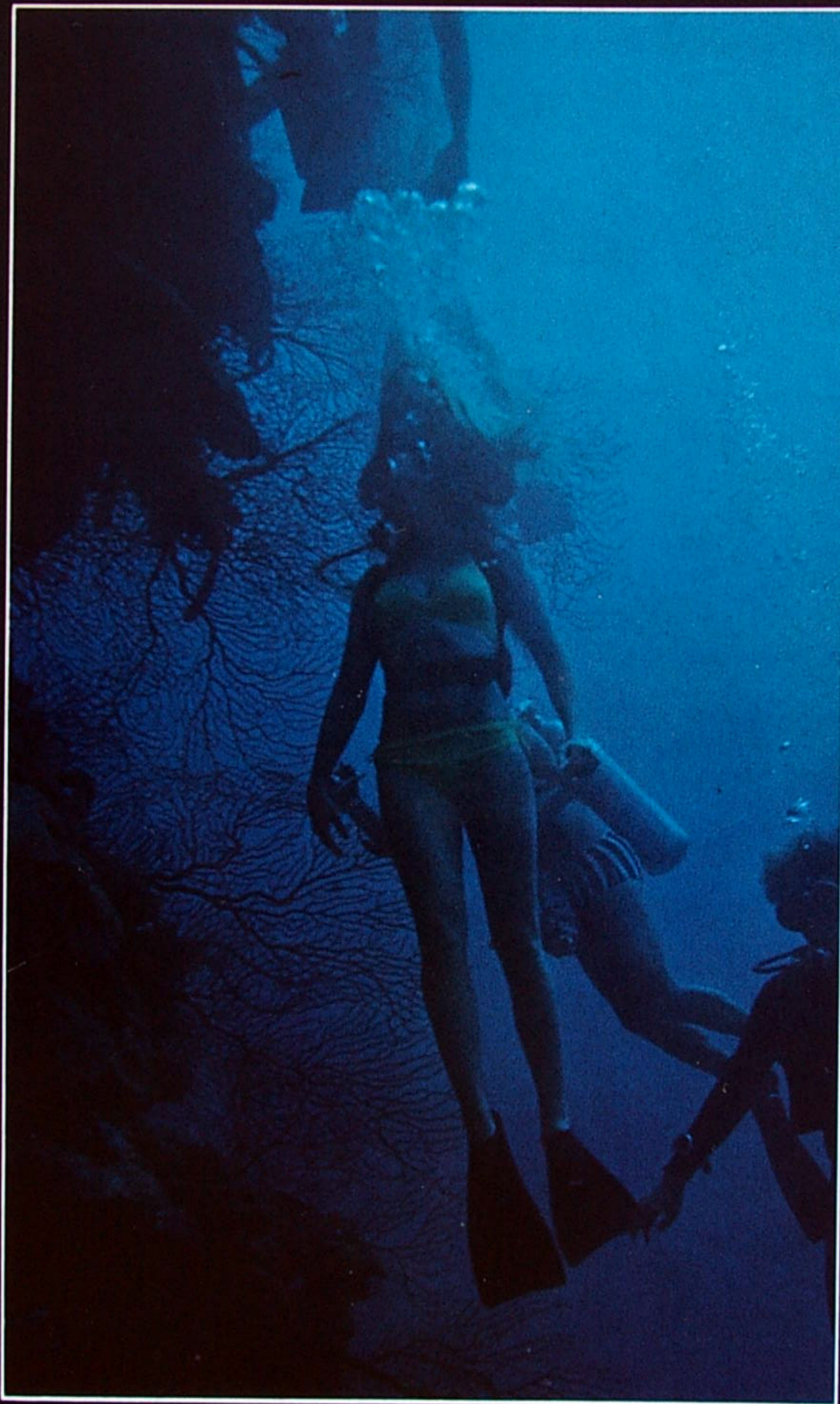

Dacor Depth Gauges

Divers are going deeper and staying longer. They are eager to explore new areas. In order to participate in this exploration of the deep, the diver needs an easy to read and accurate instrument to measure depth. The seven depth gauges shown below represent the ultimate in accuracy and dependability.



A Model OFG150—Oil Filled Professional Depth Gauge

This new precision gauge was designed for those who demand the best in depth measurement accuracy and trouble-free operation. Highly sensitive diaphragm activated mechanism with separate oil chamber. Accuracy assured by molded pressure channels. Rugged one-piece molded case and strap with triple plated buckle. Luminous dial reads to 150 ft. **35.00**

B Model OFG300—Oil Filled Professional Depth Gauge

Same features as OFG150, but reads to 300 ft. **35.00**

C Model DGD150—Professional Depth Gauge

An accurate, sensitive instrument for measuring underwater depths. Designed for rugged professional use, with double metal plates to protect the working mechanism, large chrome plated entrance port and easy to read luminous dial. Dial reads to 150 feet. **22.00**

D Model DGD300—Professional Depth Gauge

Same features as DGD150 but reads to 300 feet. **22.00**

E Model CDG—Depth Meter

Here's an easy to read depth meter that is economical and accurate. Capillary type. Reads to 250 ft. **6.95**

F Model DGR100—Depth Gauge—New Improved Design

Highly accurate, corrosion resistant mechanism. Cycloac case. Large luminous dial for easy reading. One piece molded rubber case and strap for extra gauge protection. Reads to 100 feet. **14.95**

G Model DGR200—Depth Gauge

Same features as DGR100 but reads to 200 feet. **14.95**

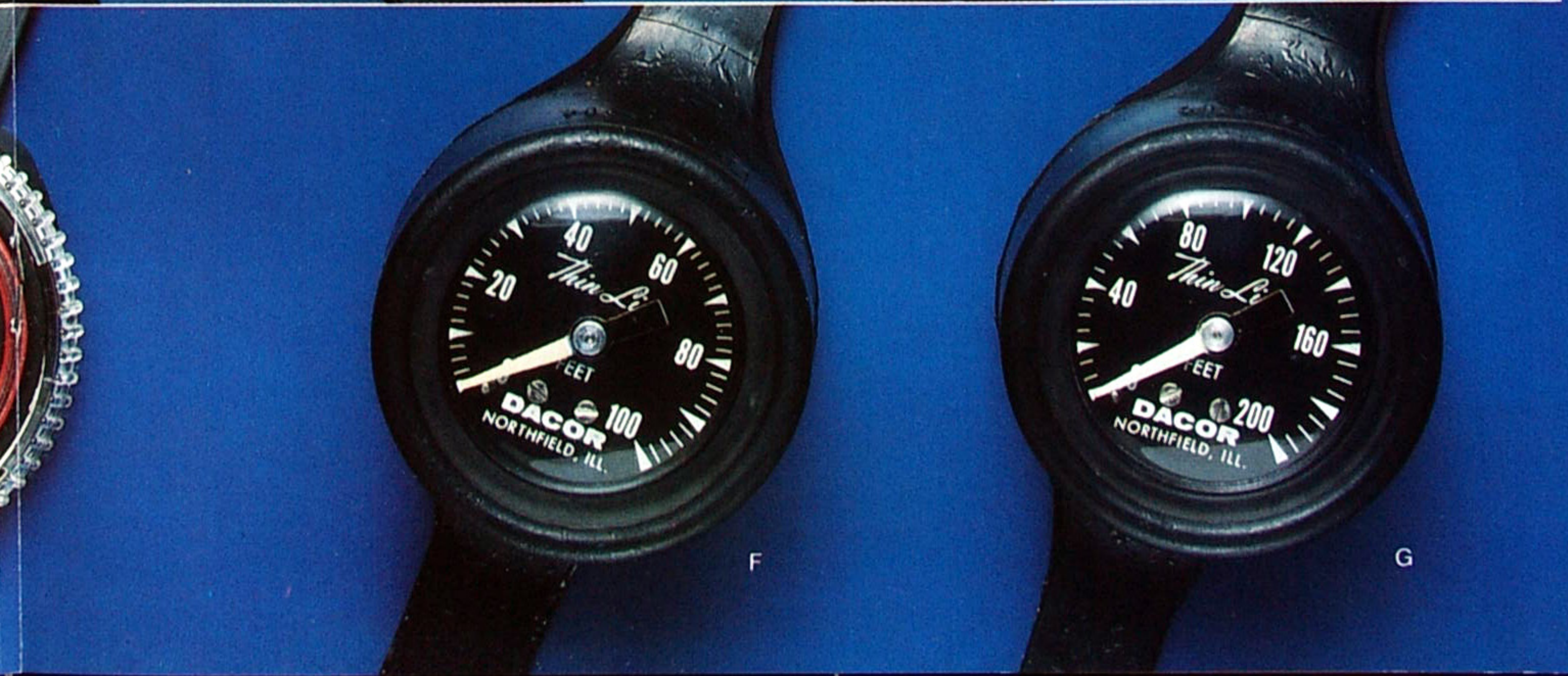
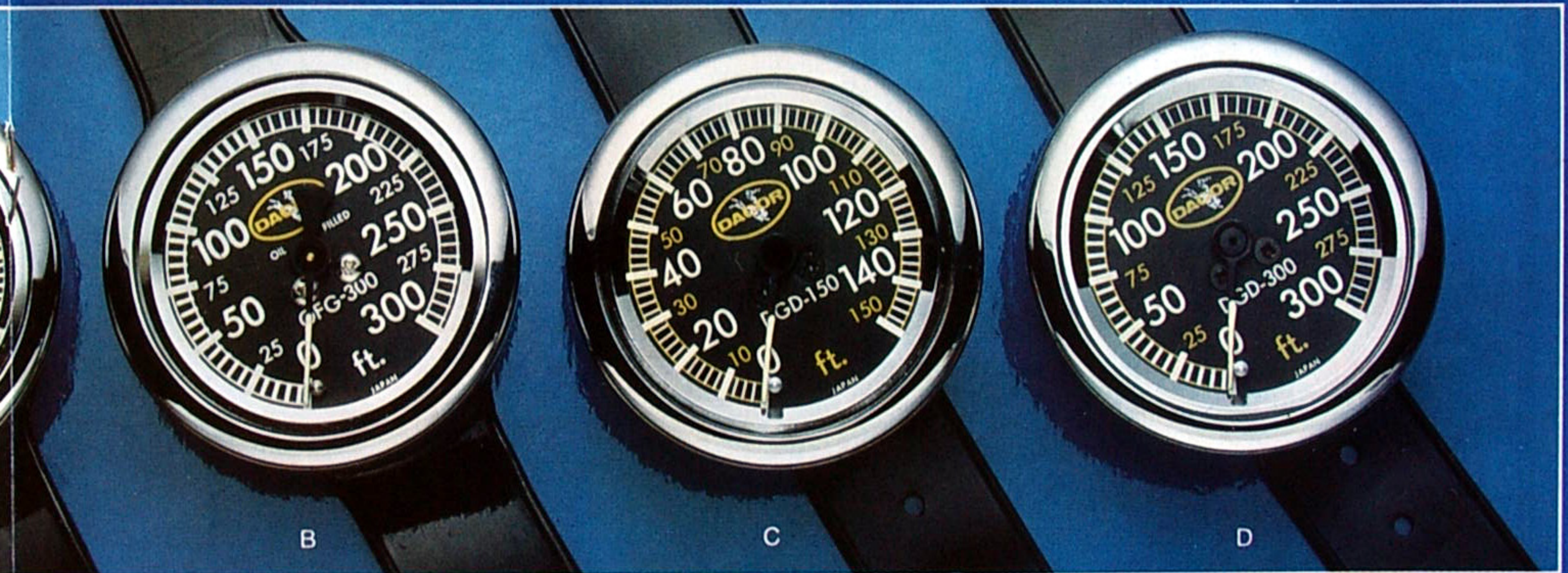

Watch



A Model DDW—New Professional Diver's Watch

Excellent readability through flat mineral crystal which is highly scratch resistant. Stainless steel bezel ring with two-way click stops to prevent accidental movement. Stainless steel case and band. Seventeen jewel automatic wind movement. Luminous dial. Quick set calendar. Three position screw-down crown: 1-locked down for pressure proof seal, 2-one step out for time set, 3-second step out for calendar set. Pressure tested to 660 feet.

125.00

Compasses



B Model DCP—Navigation Compass

New plastic corrosion-proof compass. 360 degree markings with a rotating sighting bezel. Accurate and easy to read dial. Specially designed with luminous markings for underwater navigation.

11.95

C Model WC—Watch Band Compass

Newly designed precision made mechanism with high impact crystal. Silicone oil filled chamber. Dial has luminous directional arrow and is balanced for free movement on a frictionless bearing. Fits on watch band or depth gauge strap.

6.95

D Model WTO—Oil Filled Wrist Thermometer

Super sensitive element measures water and air temperature accurately and quickly. Silicone oil filled chamber provides 25% magnification of dial for easier reading and greater shock protection and accuracy.

6.95

Pressure Gauges



Model PGR—Deluxe Tank Pressure Gauge

Chrome plated brass model features shock resistant neoprene gauge cover. Large knurled relief screw is easy to turn; yoke swivels, enabling gauge to be turned for easy reading. Body is machined from solid brass stock, forged yoke and screw. **19.95**

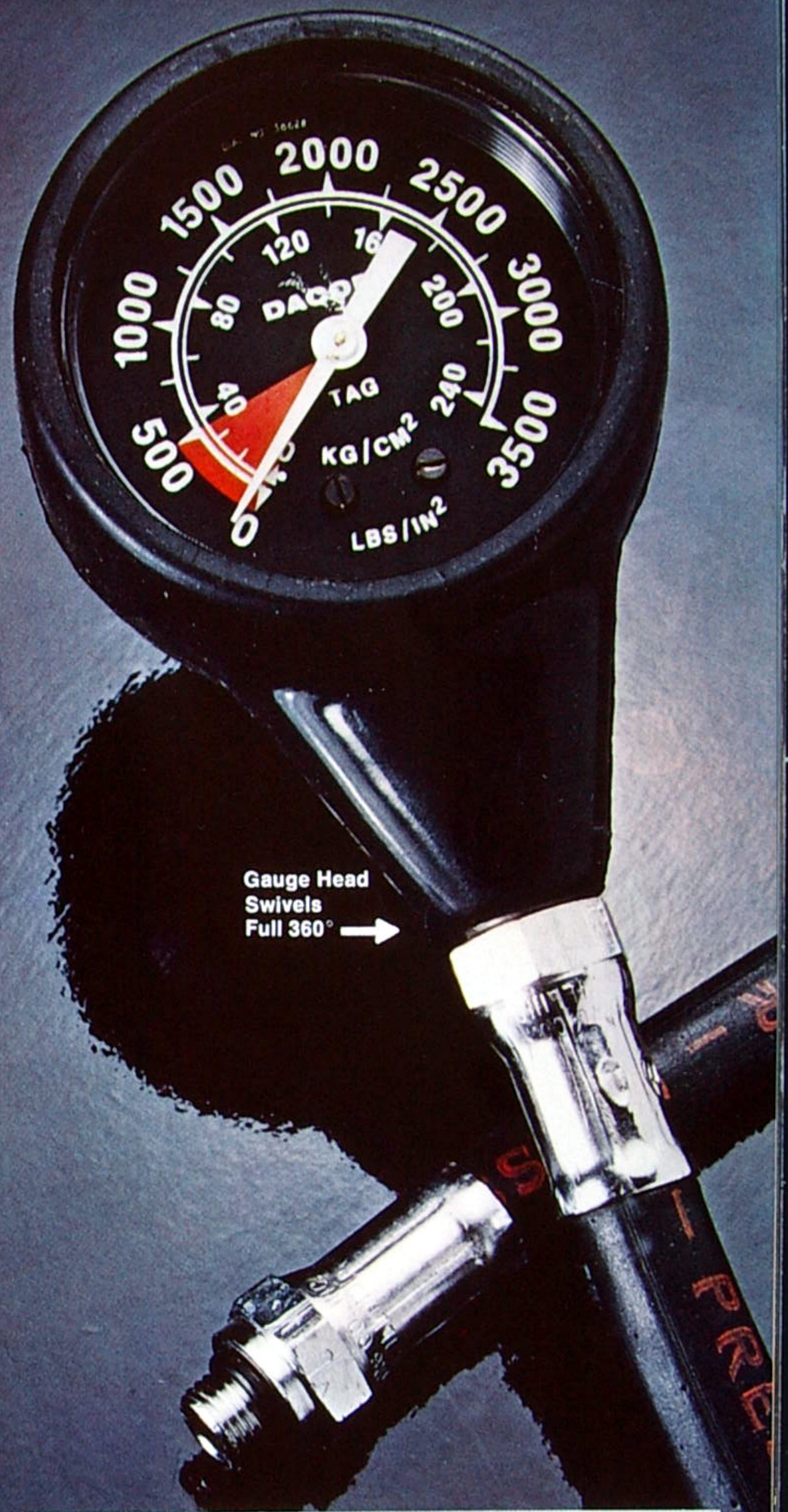

Gauge Head Swivels Full 360° →

Model TAG—Underwater Pressure Gauge

A completely new professional gauge designed to meet the demands of higher pressure systems. Large, easy to read, luminous dial scale reads to 3,500 p.s.i. and 240 kilograms with reserve scale indicator. New "sure grip" contour shape and full 360° swivel head. Shock absorbing rubber cover over strong LEXAN® case with built-in overpressure relief valve. **35.00**

Dacor Under the Ice



There's no better test for a wet suit than to wear it under the ice. This is the type of stress testing we do with all our equipment, but with wet suits it is necessary for a diver to relate his own feelings of comfort and warmth. There really is no better or accurate method of testing. Divers who use our "Thermo-skin" wet suits in ice diving situations like the ones shown on this page have confirmed the fact that Dacor suits fit better, wear longer and provide the warmth and comfort necessary for extended periods under ice.



BLUE NYLON
LINING



TUFF-TEXTURED
EXTERIOR

New Dacor Thermo-Skin Wet Suits For Men And Women

New blue nylon lined THERMO-SKIN is softer and stronger—twists, bends and moves with you—for maximum comfort and heat retention. Tuft-textured exterior with nylon lining bonded to closed cell neoprene. Every suit is contoured to fit perfectly. Suits have twist locks, high collars, triple glued sewn seams and high waisted pants. 5 heavy duty zippers.

Dacor Wet Suits

A Men's Wet Suit

Model MS3—Men's jacket and pants—3/16" Tuff-Textured exterior—blue nylon lined. **85.00**

Model MS4—Men's jacket and pants—1/4" Tuff-Textured exterior—blue nylon lined. **92.00**

B Women's Wet Suit

Features an additional easy entry zipper at waist, form fit bust cut, and contoured legs.

Model WS3—Women's jacket and pants—3/16" Tuff-Textured exterior—blue nylon lined. **85.00**

Ski Jackets

A buoyant jacket with unique underarm design that allows freedom of movement while skiing or surfing. 3/16" Tuff-Textured exterior, blue nylon lined interior, all seams triple glued and sewn, one zipper, crotch strap with twist locks.

C Model SJM—Men's ski jacket. **40.00**

D Model SJW—Women's ski jacket. **40.00**

E Model VS Vest-1/8"

Tuff-Textured Exterior, blue nylon lined. Excellent for extra warmth under wet suit jacket or by itself for water skiing, surfing, or protection from sun when skindiving. Sizes: Small, Medium, Large, Extra-large. **18.95**

F Hoods

Contoured three piece crown with full chin piece and long gauntlet front and back for maximum protection and comfort. Tuff-Textured exterior, blue nylon lined. Sizes Small, Medium, Large.

Model HD3—3/16" hood. **10.25**

Model HD4—1/4" hood. **10.85**

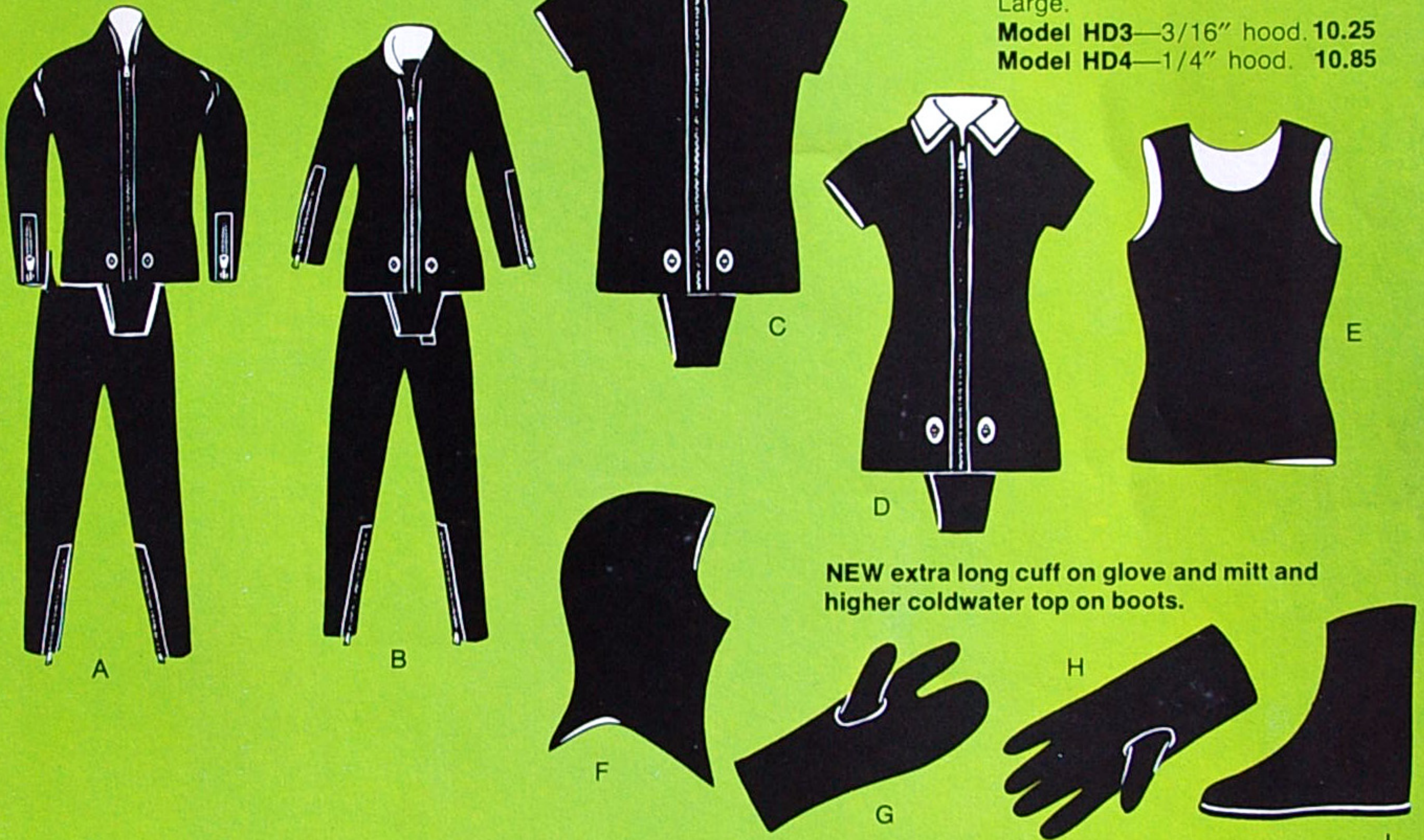

NEW extra long cuff on glove and mitt and higher coldwater top on boots.

G 3 Finger Mitts

Three finger mitts—inset thumb with sewn stress points. Provides protection and insulation. Tuff-Textured exterior, blue nylon lined. Sizes Small, Medium, Large.

Model MT4—1/4" Mitts. **11.60**

H 5 Finger Gloves

Five finger gloves—inset thumb with sewn stress points. Provides comfortable and easy movement for all fingers and thumb. Tuff-Textured exterior, blue nylon lined. Sizes Small, Medium, Large.

Model GL3—3/16" gloves. **14.00**

I Hard Sole Boots

Hard traction sole, nylon lined top, with stress points sewn. Tuff-Textured exterior, blue nylon lined. Sizes, Small, Medium, Large, X-Large.

Model HB3—3/16" boots. **12.00**

Model HB4—1/4" boots. **12.60**

Size Charts

Men's Suit and Jacket Size Chart

	Small	Medium	Large	X-Large
Chest	34-36	37-39	38-41	41-44
Waist	30-32	32-34	34-36	36-40
Weight	125-150	150-170	170-190	190-220
Height	5-5 5-9	5-7 5-11	5-10 6-2	5-11 6-3

Women's Suit and Jacket Size Chart

	Small	Medium	Large
Bust	32-34	34-37	36-38
Waist	22-24	23-26	26-30
Hips	32-36	34-38	36-40
Weight	100-120	110-130	125-145
Height	5-0 5-6	5-2 5-8	5-4 5-10
Dress	10-12	12-14	14-16

Dacor Buoyancy Compensator

Today's diver, through more extensive travel and more diverse interests, is confronted with a wider than ever range of diving conditions including temperature, depth, salinity; and tidal, wind, and current action. These varying conditions have created the need for finer, more exact control and adjustment of buoyancy. Both basic and advanced training classes now place greater emphasis on the precise control of buoyancy as part of the dive plan.

To meet this new need, Dacor has designed the new CV series vests. These new vests allow the specially trained diver to enjoy and more efficiently pursue sport, wreck, photo, cave, and commercial diving. The diver is assured of design flexibility and quality that enable him to be more proficient in the water under a wider variance in water conditions.

A Model CV-50 Multiple Capacity Compensator Vest

80.0

Large volume capacity. Gusseted construction of high tensile strength urethane-nylon over urethane inner bladder. Tough ultrasonically welded seams and sewn edge binding. Features automatic relief valve, true spiral inflate-deflate hose with Dacor's new lip-stop coldwater mouthpiece; maximum efficiency with comfort under all water temperature conditions. New "Kwik" harness with collar fastened crotch strap and shoulder straps. Eliminates waist belt. Has drain, twin pockets and 25 gram CO/2 cartridge. Provides over 32 lbs. of buoyancy at the surface, and up to 13 lbs. at 132 ft. with additional (optional) 25 gram CO/2 booster kit. Designed for the advanced diver. Can also be equipped with single or dual 16 gram CO/2 for use where less buoyancy is desired. Available in orange or charcoal.

FEATURES AND SPECIFICATIONS	CV-50	CV-25	CV-16	FDV-1+	DV-4+	MV-1+
Urethane coated nylon/ultrasonically welded in orange or charcoal gray.	●	●	●			
Internal urethane bladder/gusseted external construction—vest expands outward.	●	●				
Automatic overpressure relief valve.	●	●	●			
Long true spiral type inflator-deflator hose with lip-stop coldwater mouthpiece.	●	●	●			
New "Kwik" harness with "D" ring shoulder straps and collar fastened crotch strap. Eliminates waist belt.	●	●				
Sewn edge binding for extra strength.	●	●	●	●	●	●
Lanyard attached nylon drain for cleaning and flushing convenience.	●	●				
Drainable inflator mechanism.	●	●	●	●	●	●
Check valve in CO/2 detonator prevents CO/2 loss and water entry when cartridge is unscrewed.	●	●	●	●	●	
Buoyancy chart comes with vest.	●	●	●			
Belt fastened crotch strap/standard harness.			●			
Collar fastened crotch strap/standard harness.						●
Standard harness/no crotch strap.				●	●	
Standard oral inflator/deflator.				●	●	●
Rubber coated nylon/heat sealed seams, yellow.				●	●	●
CO/2 cartridge standard equipment size.	25	25	16	16	16	8
Optional CO/2 sizes.	16*	16	—	—	—	—
Buoyancy at surface in lbs.	32	23	20	20	18	10
Uninflated dimensions/Length-Width.	25-19	20-14	24-14	20-10	24-16	20-14
Fully inflated dimensions/Length-Width-Depth.	23-18-7	19-12-5	22-13-5	21-13-5	22-16-4	18-10-4
Gusseted pockets with drain and velcro closure.	2**	1	—	—	—	—
Split type pocket.	—	—	1	—	1	—

*Or additional 25 gram. **Pockets mounted on abrasion panel for extra strength.
+ See page 32 for these vests.



Vests

B Model CV-16 Compensator Vest 55.00

Urethane coated nylon single panel construction with ultrasonically welded seams. Equipped with relief valve, true spiral hose and lip-stop mouthpiece. Has standard harness with belt fastened crotch strap and split type pocket. Provides maximum of 20 lbs. buoyancy at surface. Comes with 16 gram CO/2 cartridge. Available in orange or charcoal.

C Model CV-25 Multiple capacity Compensator Vest 65.00

Medium volume capacity. Gusseted construction of high tensile strength urethane-nylon over urethane inner bladder. Tough ultrasonically welded seams and sewn edge binding. Features automatic relief valve, true spiral inflate-deflate hose with Dacor's new lip-stop coldwater mouthpiece: maximum efficiency with comfort under all water temperature conditions. New "Kwik" harness with collar fastened crotch strap and shoulder straps. Eliminates waist belt. Has drain, single pocket and 25 gram CO/2 cartridge. Compact size yet provides 23 lbs. of surface buoyancy. Can also be equipped with 16 gram CO/2 cartridge (optional). Available in orange or charcoal.

D Booster Kits/Dealer installed options to change buoyancy of CV-50 and CV-25 vests to match experience, training, and needs of the diver; Model BK25 (25) . . . 25-gram CO/2 cartridge, detonator, pull cord & knob. Model BK16 (16) . . . 16 gram CO/2 cartridge, detonator, pull cord & knob. (not shown)

B

C

Unique New "Kwik" Entry Harness

(Models CV-50 and CV-25)



Insert arms through loops formed by straps and pull vest over head.



Pull ends of straps forward until snug.



Grasp crotch strap and attach clip to "D" ring on bottom of vest. Adjust buckle to fit.

Dacor Inflatable Vests

FDV in use



Wearing position.



Inflator pulled—vest opens.



Vest fully inflated

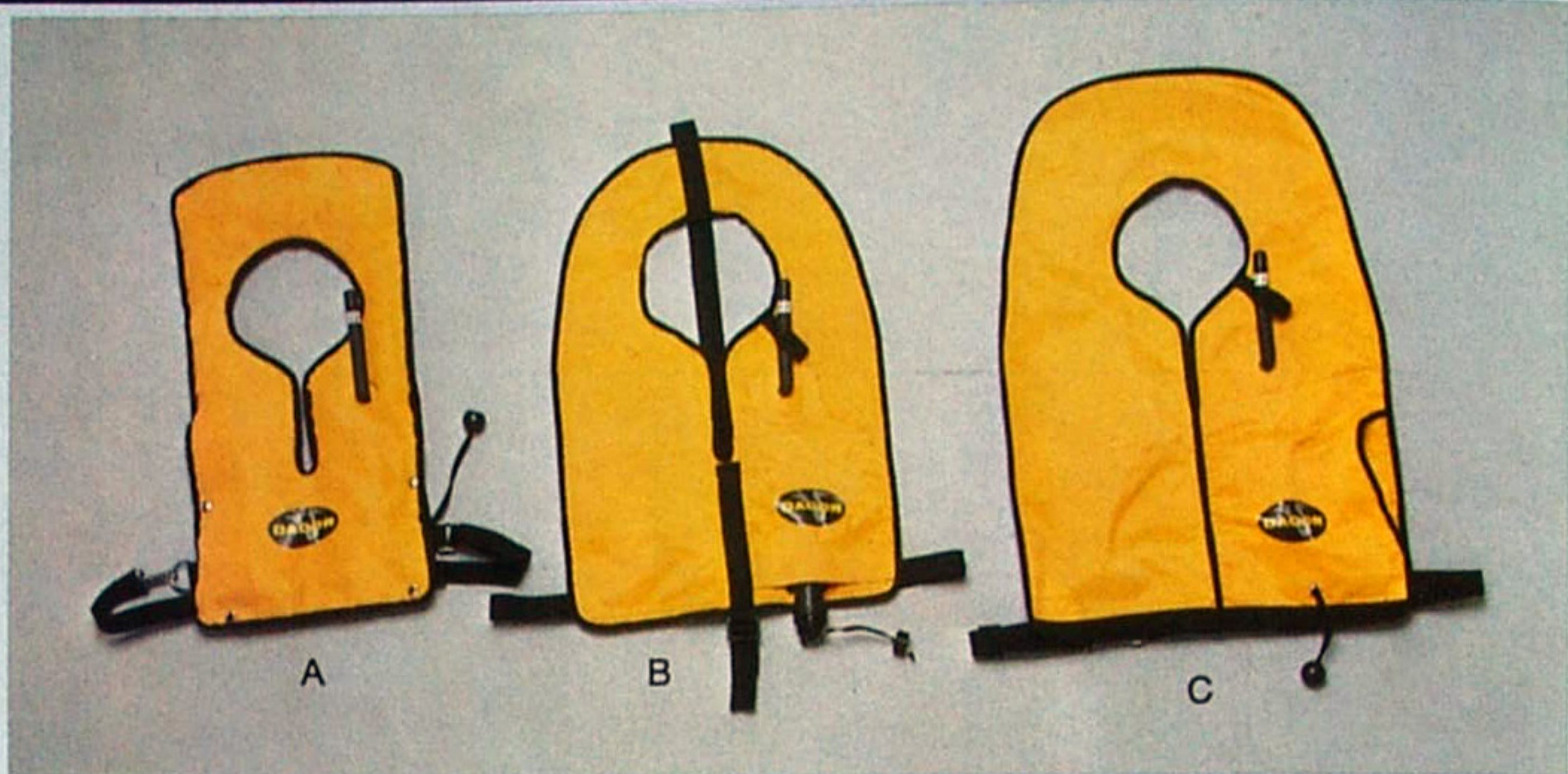

A Model FDV-1 Fold-Away Vest
With new Non-corrosive Inflator mechanism. A standard size vest that folds into a small compact pouch which measures 10" x 20". When inflation is required, pouch opens automatically. Heat fused seams with edge binding for added strength and comfort. Oral inflator protrudes through outer cover panel. Uses 16 gram CO₂ cartridge. Yellow only. **45.00**

B Model MV-1 Mini Inflatable Vest
Easy to operate, non-corrosive CO₂ mechanism with 8 gram cartridge. Rubberized nylon fabric with oral inflator and crotch strap. Ideal for children for use in boats and shallow water snorkeling. Yellow. **28.00**

C Model DV-4 Inflatable Vest
With New Non-Corrosive Inflator Mechanism. Designed in rubberized nylon with form fitting collar and heat fused seams with special edge binding for added strength. Shorter and more comfortable, it does not interfere with weight belt. Features split pocket, quick release harness. Oral inflator. 16 gram CO₂ cartridge. Available in yellow only. **36.00**

Dacor Flags and Floats

A Model IDF—Inflatable Buoy With Diver's Flag
Unique water compartment in base keeps flag in upright position even in rough water. Self-righting, bright red and white color. Use as marker buoy, diver's flag and resting flotation device. "DIVER BELOW" spelled out in large block letters. **13.95**

B Model DSF—Diver's Safety Flag
A necessary safety precaution. Attaches to inner tube by corrosion resistant metal bracket and adjustable strap. Three foot black fiberglass shaft holds 12" x 15" diver's flag. Flag is supported in outright position. **7.50**

C SFY-1 Inflatable Float Yellow
SFB-1 Inflatable Float Black
Provides positive buoyancy of 8½ lbs. at surface. Excellent for use as a float, marker buoy, lifting device and spearfishing aid. New design features 100% corrosion resistant Cyclocac housing. Lever action inflates easily. Special cartridge retainer makes it easy to remove and replace low-cost seltzer cartridges which are available everywhere. **9.95**

D SFB-2 Dbl. Inflatable Float Blk.
SFY-2 Dbl. Inflatable Float Yel.
Provides positive buoyancy of 18 lbs. at surface. Double float equipped with fastening straps.

Same features as SF-1, but larger in size with double cartridge, one at each end. Double float equipped with fastening straps. **15.95**



Dacor Knives

A Model DKB—Knife and Sheath

7" long, hand-forged Solingen stainless steel blade will keep its edge far longer than ordinary diving knives. With molded non-slip rubber handle and combination leg and waist sheath. Exclusive serrated saw edge; markings on blade for measuring abalone. **25.00**

B Model DKM—Knife and Sheath

A smaller version of our Model DKB—the largest selling knife in the diving industry. Hand-forged Solingen stainless steel with 6" blade and non-slip rubber handle. Sheath fits waist or leg. **24.00**

C Model KBC—Knife and Sheath

Heavy duty stainless steel 7" blade molded into tough contoured plastic handle. Combination leg and waist sheath. **13.95**

D Model KSC—Small Knife and Sheath

Same as Model KBC, but with 6" blade. **12.95**

E Model SKB—Small Knife

Small but rugged. Specially designed 4½" stainless steel blade with double serrated edge for added strength, cutting and filleting efficiency. Plastic belt sheath. **7.95**

F Model DDT—Diver's Tool

Specially designed for working underwater—prying, cutting, sawing. One serrated edge and one sharp edge with angled tip. Stainless steel blade, rubber handle, wrist lanyard and sheath. **9.95**



Dacor Lights the Way



B

A. Model UL-800 Underwater Rechargeable Light

The compact powerful answer for nite, wreck, and cave diver's needs. Provides initial 100,000 candlepower from amazing new 4 ampere hour 6.4 volt electrogel battery. Produces 2 hours of usable light and recharges in 10-15 hours. Will not exhibit sudden loss of power as do most other rechargeable batteries. Has superior self-recovery rate and over three hour duration in typical intermittent diver use. Light floats sealed beam up and operates to maximum depth of 700 ft. Durable cyclac body. **45.00**

Model BCH-800 Charger

Recharges Model U1-800 electrogel battery. Operates on AC 110/115 volt, 60 Hz. **6.95**

B. Model UL-700 Underwater Light

High intensity sealed beam produces 50,000 initial candlepower when used with heavy duty 6 volt batteries*. Provides 2½ hours of usable light. Buoyant-floats sealed beam up and operates to maximum depth of 700 ft. Durable cyclac body. **19.95**
* (like Ray-O-Vac or equivalent).

C. Model DF-1 Diver's Flasher

This new xenon strobe is specifically designed for night and limited visibility diving. Excellent as signal light, distress flasher, buddy-to-buddy beacon, or warning device. Powerful mercury battery included. Guaranteed pressure proof to 275 ft. Molded-in solid state electronic circuitry and transformer. Emits 150,000 peak lumens per flash and 50 flashes per min. Visible up to 12 miles at surface. Magnetic switch. Operates 9-25 hours continuously and from 18-30 hours intermittently. Attach with velcro armstrap included or to eyelet with lanyard. **56.00**



A

C

Weight Belts and Weights



**Model WB—"Quick-Ditch"
Weight Belt**

Sturdy 2" nylon webbing with stainless steel quick-release buckle. Belt will not slide when closed. Yellow, blue or black. **5.75**

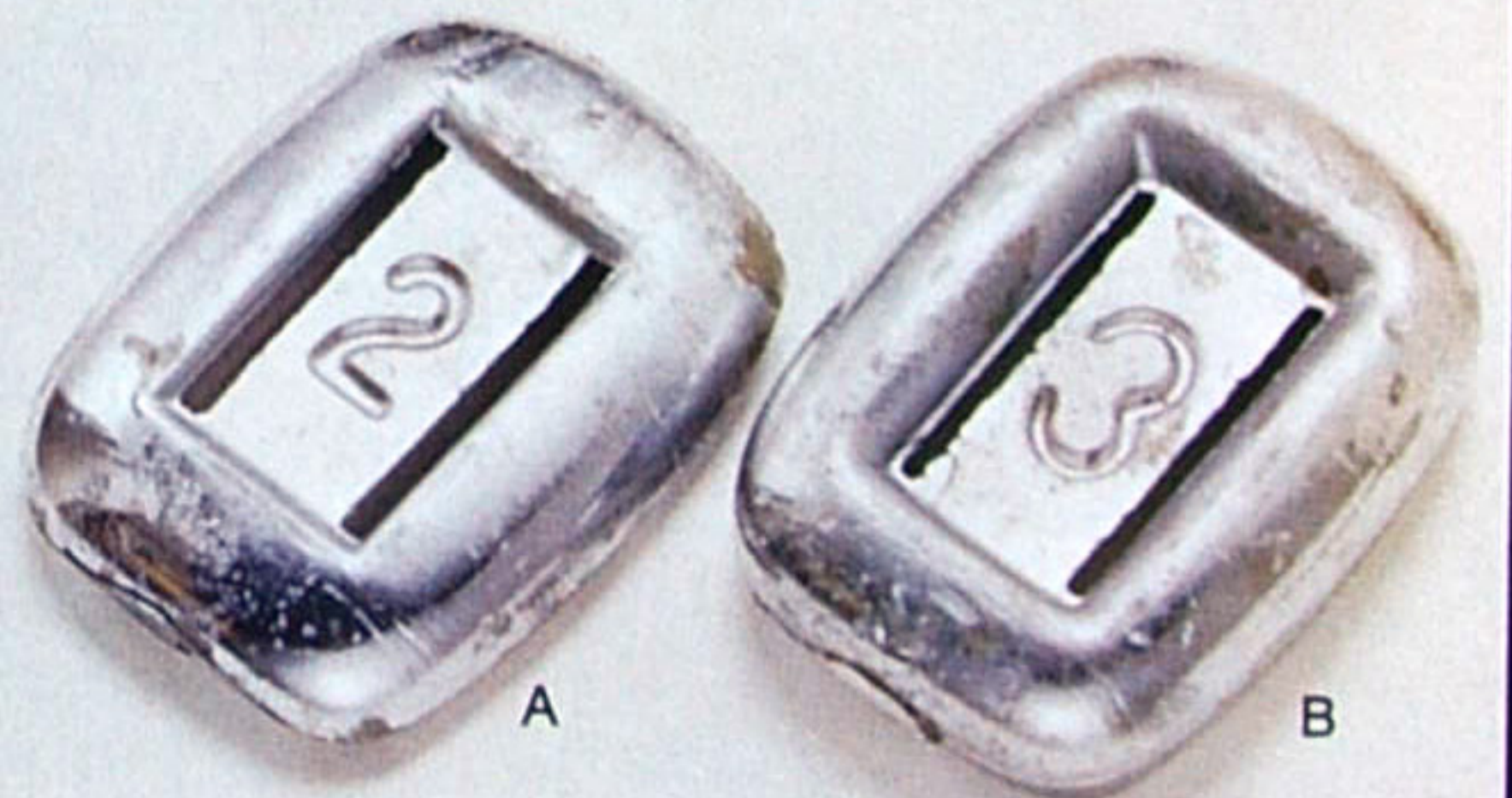

A Model DW2—Weight

Two pound custom contoured lead weight containing nickel. **3.00**

B Model DW3—Weight

Three Pound Weight. **4.50**

Dive Dacor in Style



C Model DJK—"Dive Jac"®

This new diver-styled, topside jacket is water repellent, quick drying nylon. Smartly designed for the diver to protect against the elements. Contrasting stripe, zipper front, two accessory pockets, two-button collar, elastic cuffs, and draw-string waist make this "Dive Jac"® a necessary addition to your topside gear. Adult sizes: XS, S, M, L, XL. **17.95**

D DTS—Action "T" Shirt

Styled right with color-fast, silk-screened action stripe, crew neck and trim-fit cut. Less than 2% shrinkage. Rugged enough to use in or out of the water. Sizes: XS, S, M, L, XL. **3.50**

E Model EBD—Equipment Bag Deluxe

Carry, store and protect your equipment. New heavy duty material made of highest tensile strength nylon mesh-vinyl coated both sides. Eliminates water absorption and mildew. Rugged #9 nylon zipper. Stainless steel locking ring on tab. Vents and divers flag on both end panels. Full wrap around 2" wide nylon straps with comfort contour grip. 26" long, 12" wide, 14" high. Red only. **19.95**

F Model DEM—Dacor Emblem

Be a DACOR diver. Sew this on your diving jacket, gear bag or swim trunks. **1.00**

G Model DSS—Swim Suit

Tank type suit fits trim to body. Fast drying 100% nylon with inner liner for support. Black. Sizes: 28, 30, 32, 34, 36. **4.95**

H Model CG—Coral Gloves

Protect your hands from coral and marine life. For working underwater. Rubberized exterior with strong cotton lining. Sizes: S-M-L. **4.50**

I Model REB—Regulator Bag

Designed to protect and carry your regulator. Rugged vinyl construction with brass zipper. 6½" diameter, 11" length. Medium Blue. **3.95**

J Model RLB—Large Regulator Bag

Similar to REB but large enough to carry your regulator, gauges, compass, mask, defog, small towel, etc. 8" diameter, 13" length. Navy blue. **5.50**

K Model TSU—Action "T" Shirt

In Navy blue with white silk screening on front and back. Sizes: XS, S, M, L, XL. **3.50**



Dacor Accessories



- A Model SDJ—"Dive Jot"® Underwater Sleeve Slate**
A major innovation in underwater communications. Useful for instructors, photographers and advanced divers. Circular sleeve slate you can write on and erase underwater with an ordinary lead pencil. "DIVE JOT"® fits around forearm snugly, leaving both hands free. **4.95**
- B Model SC—Wet Suit Cement**
4 oz. can. Neoprene cement for repairing suits. **1.65**
- C Model EI—Tank Equalizer**
Allows divers to equalize tank pressure in two or more tanks. Two or more divers can start out with equal tank pressure. Bleed off valve for easy detachment. Minimum 7,000 p.s.i. hose burst pressure; 3,000 p.s.i. working pressure. **29.00**
- D Model AI—Accessory Inflator**
Built-in restricted orifice for slower inflation. Fills inflatable boats, floats, tires, etc. **12.95**
- E Model AM—Marking Pencil**
Personalize your gear with this specially formulated waterproof marker for fins, masks, snorkels and other rubber equipment. Long lasting, ideal for identifying rental and class equipment. White only. **.75**
- F Model DEF—De-Fog Mask Cleaner (8 oz.)**
Cleans and fog proofs masks with one easy application. **1.50**
- G Model SIL—Silicone Spray (12 oz.)**
Formulated for use with underwater equipment as a lubricant and protector. **1.95**
- H Model DIL—Divelube (6 oz.)**
A high quality lubricant that leaves a durable protective film. Non-staining and long lasting. Ideal for wet suit zippers, camera "O" rings, knives, spear guns, rubber slings, etc. Highest silicone content available. **1.75**
- I Model SSK—Sea Sting Kit**
For on-the-spot first aid for minor wounds caused by coral, sea urchins, jelly fish and other toxic marine life. Contains topical anesthetic for pain relief, antihistamine as an itching depressant, antiseptic for anti-bacterial action. Waterproof kit with tube of ointment, surgical soap, scrub pads, 3 vials of neutralizer, instructions. **5.95**
- Model SSK-R—Refill package for SSK (not shown). 4.95**
- J Model GG—Grip-Gard Boot**
Dual purpose boot for use with or without fins. Non-slip textured innersole and rugged threaded outersole for sure footing on any surface. Non-chafing split toe design for better traction. Natural rubber with vulcanized seams and high ankle that protects against abrasions. Available in Black—shoe sizes 6-7, 7-8, 8-9, 9-10, 10-11, 11-12. **7.95**
- K Model SPB—Underwater Slate Board**
Communicate under water the easy way. High impact acrylic, with attached marking crayon. **2.95**
- L Model SRS—Scotchlite Reflector Sticker**
Pressure sensitive reflective sticker for bumper or window. 3" x 4". **.80**
- M Model VRS—Vinyl Sticker**
Vinyl pressure sensitive diver's flag decal. 3" x 4". **.50**
- N Model WSS—Tropic Watch Bands**
Men's straight attachment style. 19mm wide. Fits most watches. **3.50**
- Model WSC**
Men's curved attachment style. 19mm wide. For Dacor men's watches. (Not shown) **3.50**
- Model SSW—Stainless Steel Watch Band**
Non-magnetic, heavy-duty construction. Positive adjustable locking device. (See watch page) **12.00**
- O Model WSW**
Women's curved attachment style. 16mm wide. Fits most women's watches. **3.50**
- P Model WSB—Sport Band**
Now stronger and longer. Stainless steel buckle. A rubber watch band with truly contemporary styling. 19mm wide. **3.50**

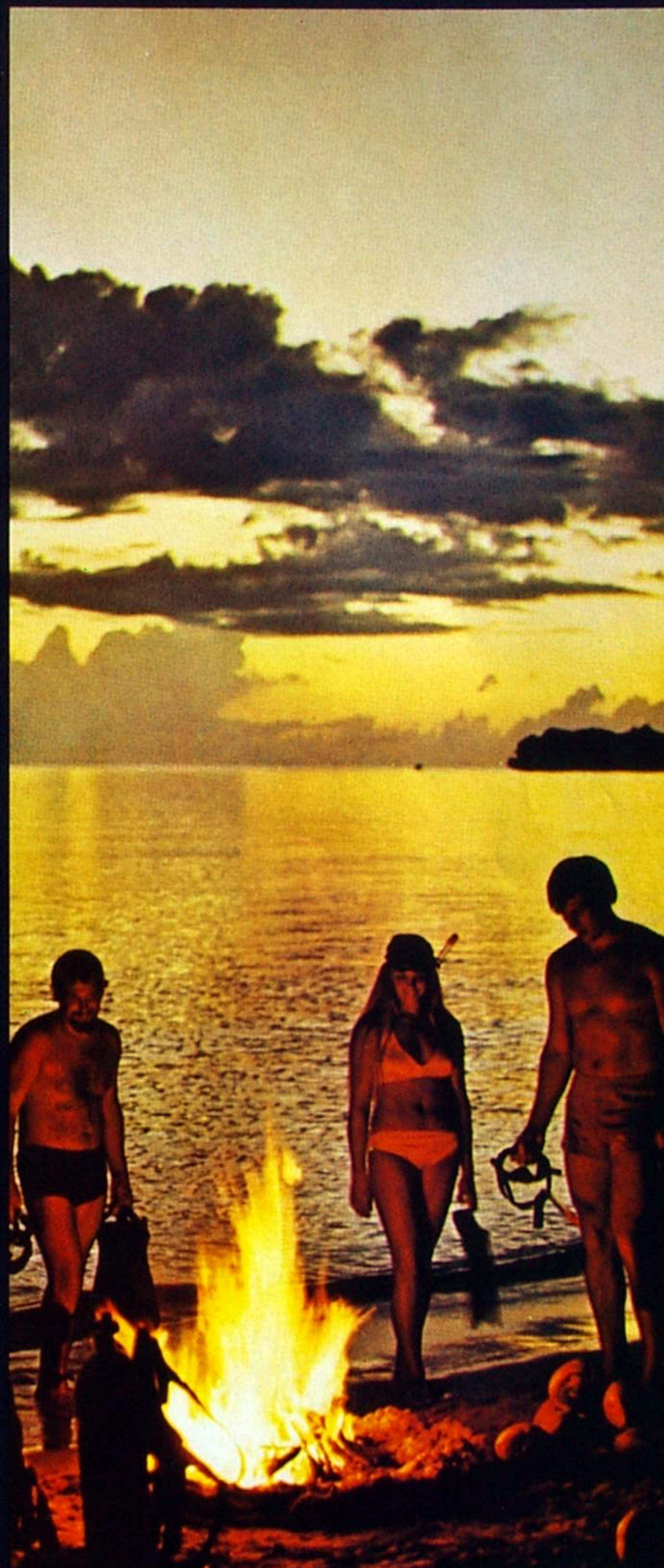

Dacor Stingray Spearguns

WE24—2 Rubbers—
24" Length, Single
Barb Spearhead.

38.00

SE35—2 Rubbers—
35" Length, 2 Barb
Stainless Steel
Spearhead. **45.00**

ME43—2 Rubbers—
43" Length, 2 Barb
Stainless Steel
Spearhead. **50.00**

LE47—3 Rubbers—
47" Length, 2 Barb
Stainless Steel
Spearhead. **54.00**



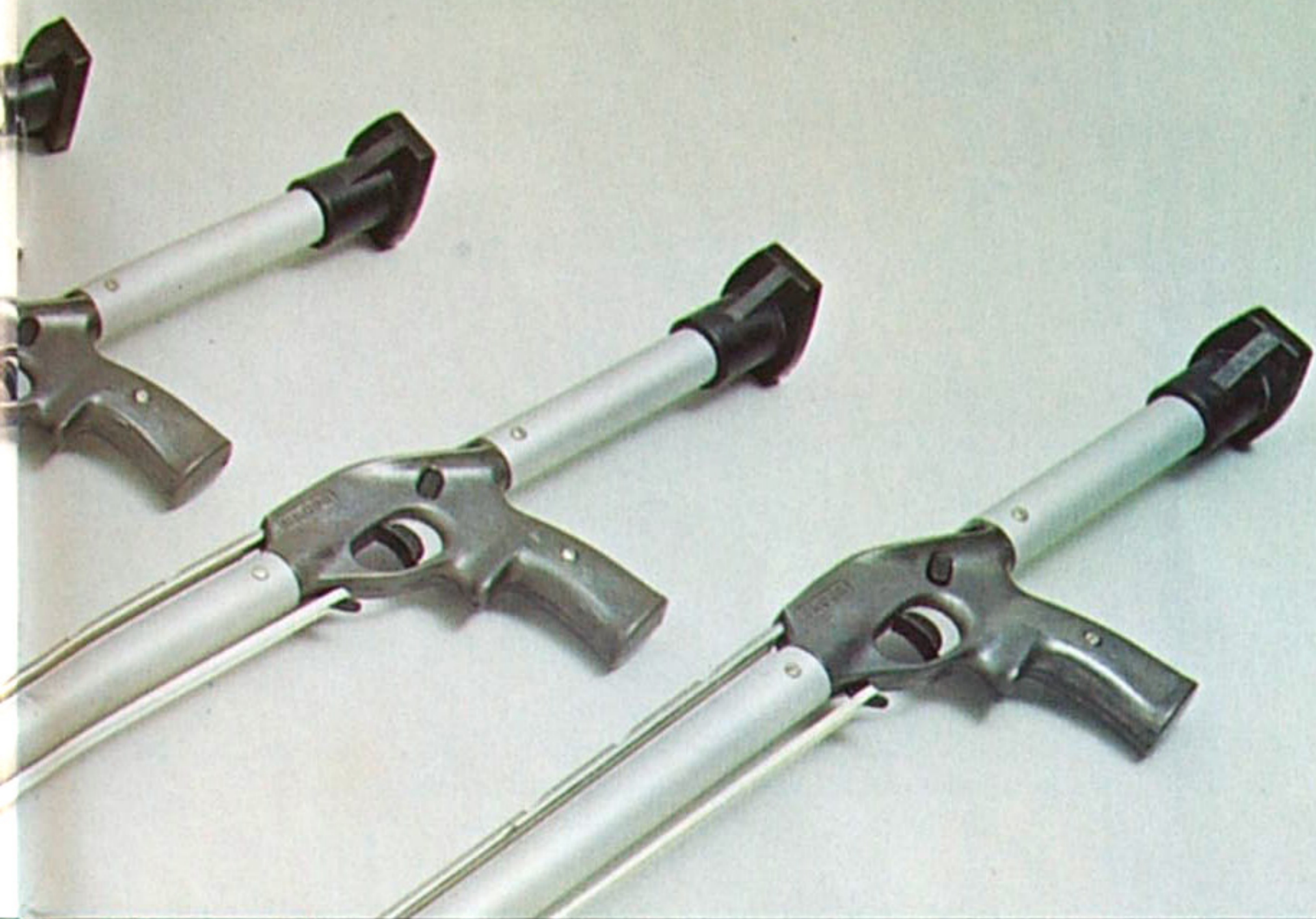

**LRG-52-I—Stingray
Balanced Grip**

Center stabilizing handle for use with larger Stingray guns. Improves accuracy. **4.95**



Fast-Action Spearguns

Small, lightweight high quality guns at an economical price. Ideal for smaller food fish and for the economy minded diver who wants to get acquainted with spearfishing skills. Easy to load; yet delivers spear with high velocity and impact.

CGL—38" long with one rubber and single barb spearhead. **18.50**

CGS—24" long with one rubber and 3 prong spearhead for greater impact power. **17.00**

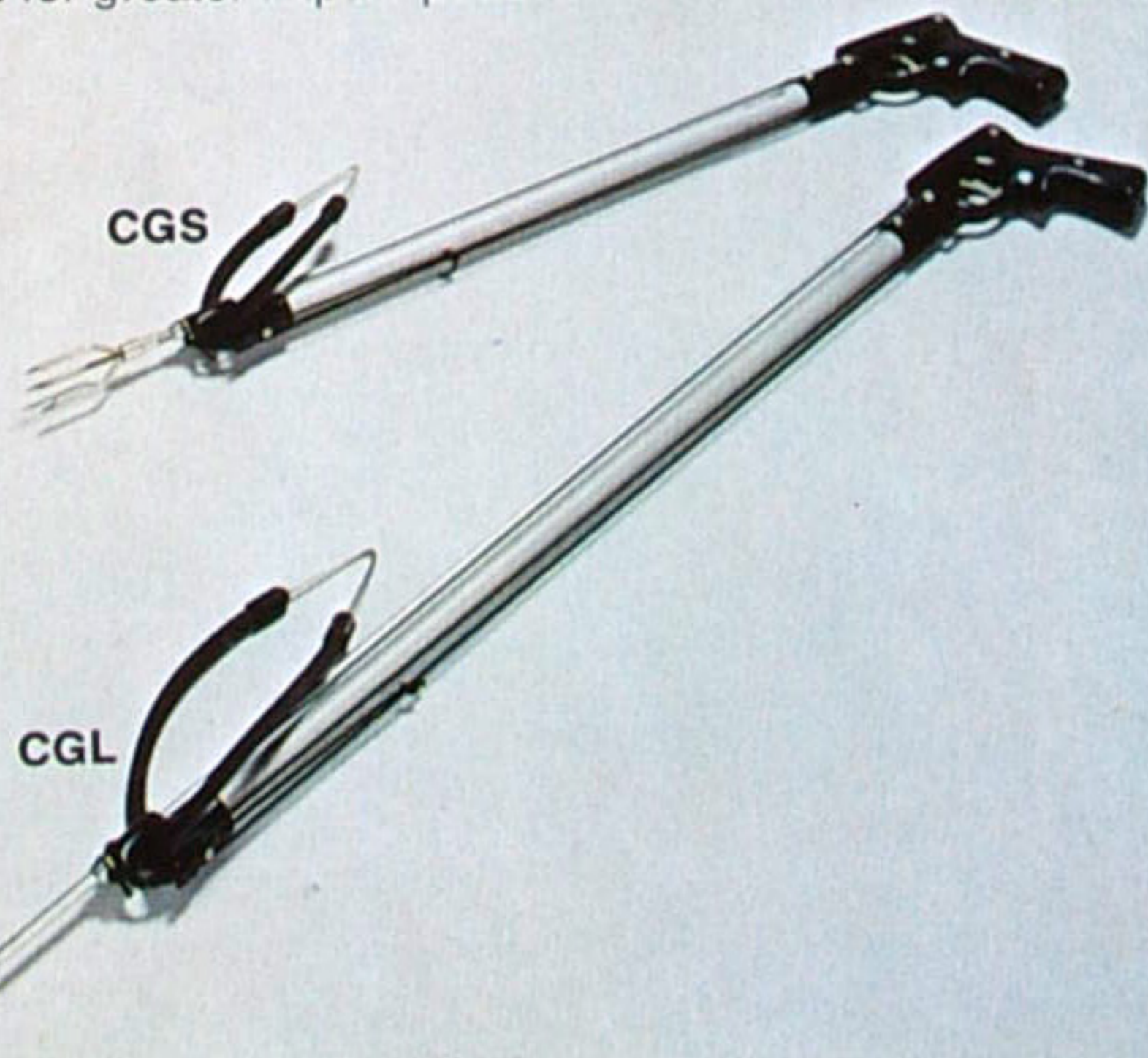

The ecology minded spearfisherman who takes only food fish is in the majority. He takes such food fish only to the limit of his own necessity and adheres to this underwater sportsman's code. In some areas Conservation Departments encourage spearfishing for "rough" fish to remove them from waters where they inhibit or upset the ecological balance of food and game fish. After five years of research in underwater weaponry, Dacor introduced the Stingray line a few years ago as the ultimate in engineering and design. Since that time, Dacor has had nothing but superlative comments from spearfishermen. Dacor has made a science out of what was once a sport. We have given care and attention to the most important part of the gun—the firing mechanism. Such factors as velocity, trajectory, foot pounds of force and many others have been given the utmost considerations in producing these high performance guns.

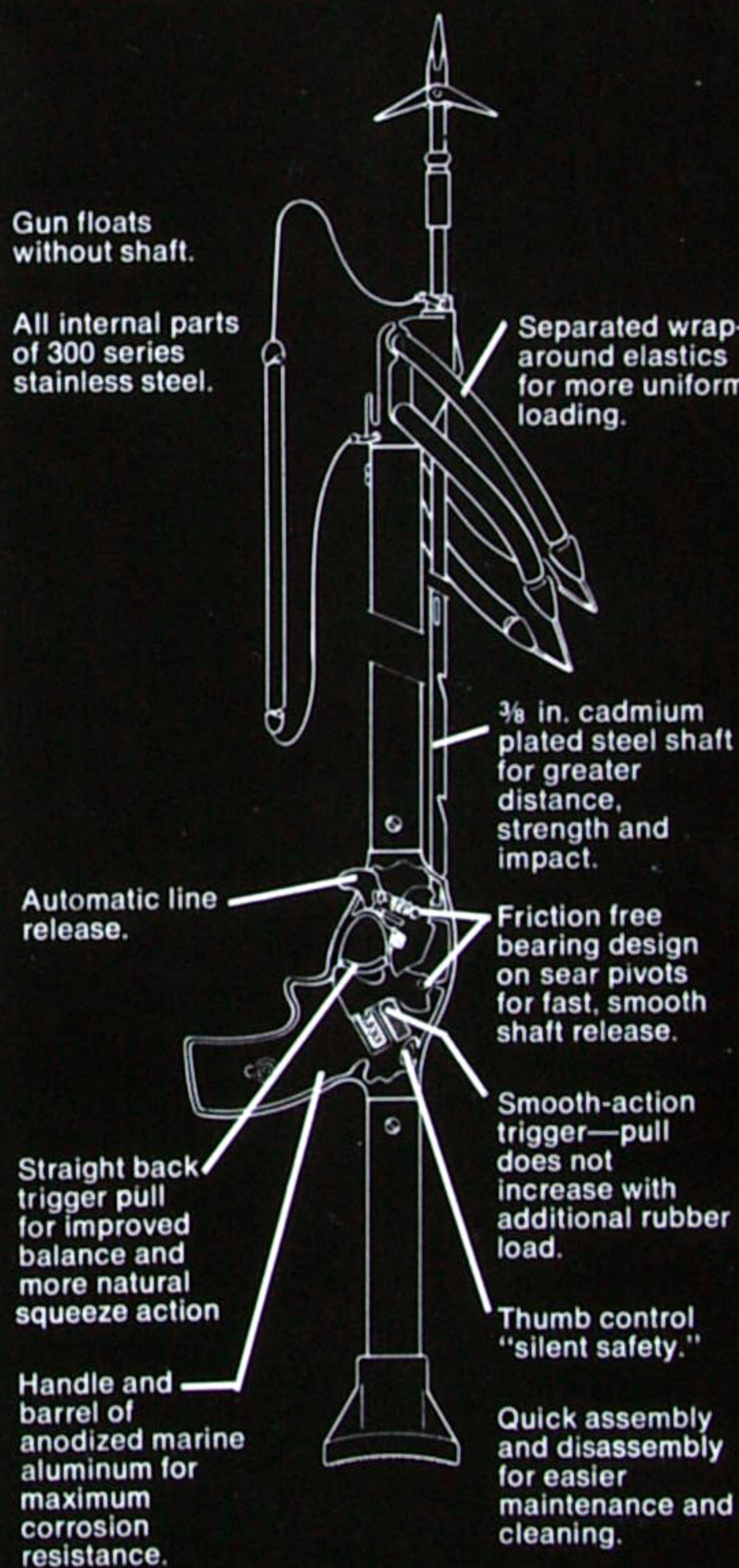

Dacor Pole Spears



- A Model TPG3-1**—Double barb. Metric thread, stainless steel, detachable spearhead and cable. Head spins free of shaft. Ideal for larger game fish. Fits WE24, SE35, ME43, LE47. **12.50**
- B Model TPG2-1**—Double barb. Metric thread, stainless steel. Fits WE24, SE35, ME43, LE47. **6.00**
- C Model TPG1-1**—Single barb. Metric thread, stainless steel. Fits WE24, SE35, ME43, LE47. **3.75**



Canvas Bug Bag
Specially designed for "bagging" lobster, but the bag is perfect for all-around use for all types of game fish or for carrying equipment. Heavy duty canvas construction with nylon mesh flow-through bottom. Stainless steel snap at top opens or locks bag with a flick of the finger.

- H Model CBB** 15" wide x 26" deep. **\$9.95**

Nylon Game Bags

One of the most useful and versatile diver's accessories. Use as game bag for lobster and fish or for collecting objects underwater. Strong mesh nylon; galvanized metal hinged hoop; locking stainless steel closure.

- I Model LBB Large Game Bag**
12" wide x 30" deep. **\$8.75**
- J Model SBB Small Game Bag**
9" wide x 20" deep. **\$6.75**
- K Model MBB Mini Game Bag**
6" wide x 15" deep. **\$5.25**

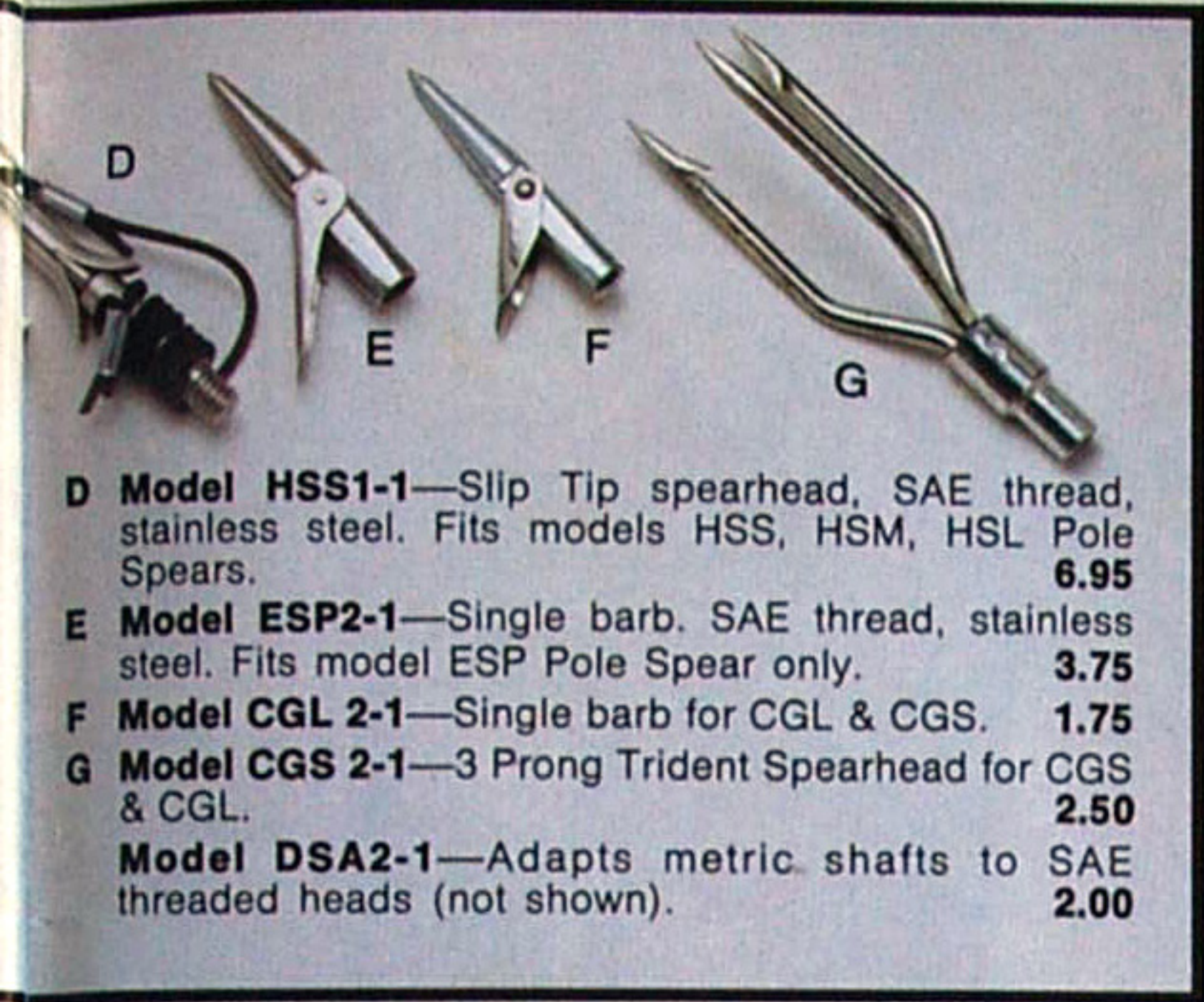

- D Model HSS1-1**—Slip Tip spearhead, SAE thread, stainless steel. Fits models HSS, HSM, HSL Pole Spears. **6.95**
- E Model ESP2-1**—Single barb. SAE thread, stainless steel. Fits model ESP Pole Spear only. **3.75**
- F Model CGL 2-1**—Single barb for CGL & CGS. **1.75**
- G Model CGS 2-1**—3 Prong Trident Spearhead for CGS & CGL. **2.50**
- Model DSA2-1**—Adapts metric shafts to SAE threaded heads (not shown). **2.00**

Fiberglass Pole Spears

Designed for easy action, minimum water resistance and maximum strike power—just the perfect balance that makes these spears, feature for feature, the expert hunter's choice. Tapered fiberglass shaft is lightweight but strong. All fittings are marine grade aluminum and are coated to prevent corrosion. Black high recovery surgical tubing is adjustable to the individual diver's requirements. All models come with detachable spearhead.

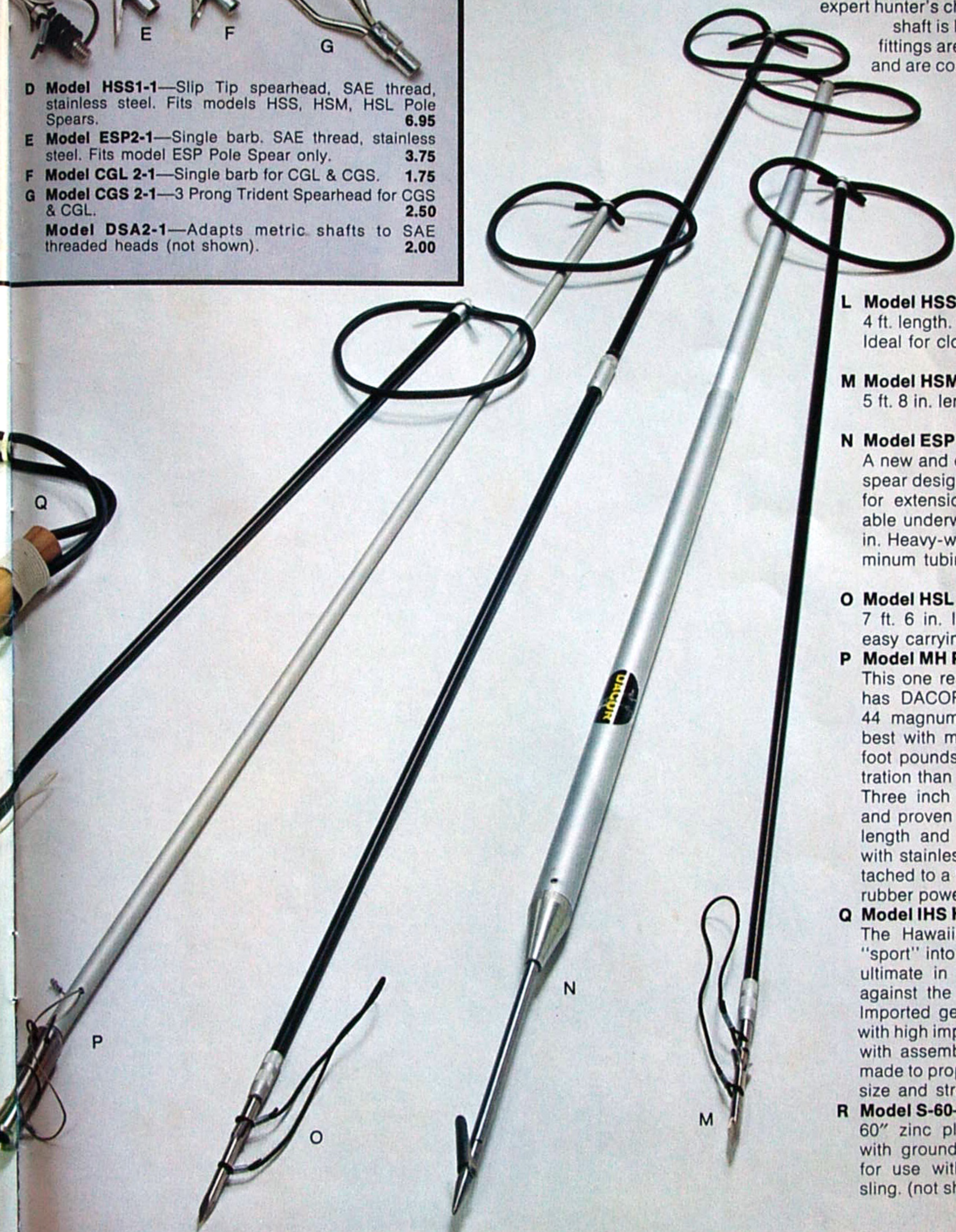

- L Model HSS Pole Spear**
4 ft. length. One piece tapered shaft. Ideal for close-in work and gig. **16.00**
- M Model HSM Pole Spear**
5 ft. 8 in. length. One piece shaft. **19.00**
- N Model ESP Aluminum Pole Spear**
A new and different twist to the pole spear design. Just a twist of the wrist for extension and locking. Adjustable underwater from 42-in. to 106-in. Heavy-wall anodized marine aluminum tubing, stainless steel shaft. **29.00**
- O Model HSL Pole Spear**
7 ft. 6 in. length. Breaks down for easy carrying and storage. **25.00**
- P Model MH Power Head**
This one really does the job, and it has DACOR built-in dependability. 44 magnum has proven to be the best with more shock power, more foot pounds of energy, more penetration than other shells now in use. Three inch barrel has been tested and proven to be the most effective length and is attached to receiver with stainless steel cable. Come attached to a 5 ft. aluminum shaft with rubber power sling. **28.00**
- Q Model IHS Hawaiian Sling Kit**
The Hawaiian Sling put the word "sport" into spearfishing. This is the ultimate in testing the diver's skill against the creatures of the deep. Imported genuine teak wood barrel with high impact rubber sling. Comes with assembly instructions. Can be made to properly adjust to your body size and strength. **5.95**
- R Model S-60—Spring-Flex Shaft**
60" zinc plated spring steel shaft with ground point and single barb for use with Model IHS Hawaiian sling. (not shown). **11.00**

Air Station Equipment



Model CP-3G—New Turbo Compressor

The Portable Lightweight. Excellent weight to output ratio. Just 110 lbs. yet fills tanks to 3,200 p.s.i. at 3 cu. ft. per min. Compact size in take-along design. 35" long, 15" wide, 19" high. Travels in car trunk, or boat. Ideal for individuals, clubs or small dive shops. Features auto. relief valve, deluxe filling attachment, separator, filter. Dependable 4.6 H.P. air cooled engine. Mounted on rugged steel frame with four rubber suspension shock absorbing legs. Turbofan moves large air volume for efficient cooling. Molded fiberglass guards over Turbofan and "V" belt drive. Deluxe hand grip carrying handles on each end. Also available in electric driven version. Larger 7 cfm portable and stationary models available in gas and electric. Complete catalog sheet available on request.



A Model DA—"O" Ring Lube

Specially formulated silicone compound for use in cameras, regulators and valves. Non-toxic and non-water soluble. 2 oz. **4.00**

B Model AC—Activated Carbon (Charcoal)

For use in air filter systems. Dust free. 1 gal. can. 4x10 mesh. **9.75**

C Model AA—Activated Alumina

For use in air filter systems. 1 gal. can. Moisture absorbent. **16.75**

D Model CO—Dacor Compressor Oil

Especially formulated for use in high pressure compressors such as Rix, Worthington, Joy, Ingersol Rand. Exceptionally low in carbon content and compounded for "continuous use" lube. 1 gal. can. **10.00**

E Model DFA—Deluxe Filling Attachment

Featuring all brass, high pressure fittings. 6 ft. long high pressure hose has minimum burst pressure of 11,000 p.s.i. Includes line valve and bleeder valve. Comes with 3,500 p.s.i. gauge. **72.00**

F Model SFA—Standard Filling Attachment

Same as Deluxe Filling Attachment, but without line valve. **58.00**

G Model LV—Line Valve

Easy on/off fingertip control. Forged brass body, 3,500 p.s.i. working pressure. 1/4" N.P.T. male and female thread. **15.00**

H Model TP—Touch-Up Paint & Equipment Marker

Touch-up and personalize tanks, back paks, etc. Built-in brush, mechanical agitator, and rubbing compound. Available in these seven factory approved colors: yellow, clear, medium blue, dark blue, metallic blue, and bronze. **1.95**

Instructors' Corner

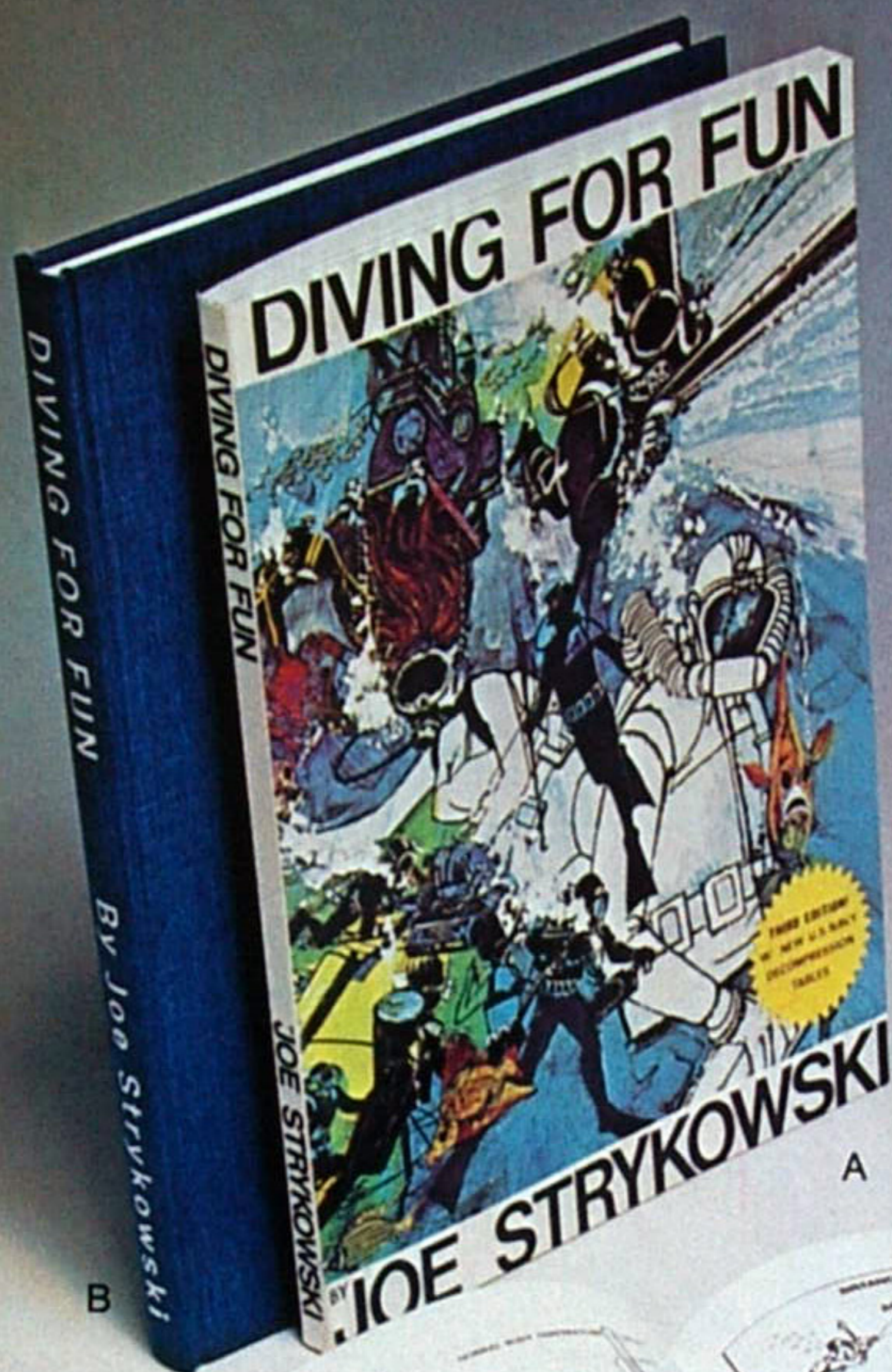

LEADING BASIC SCUBA TEXT

A Model BK—Diving For Fun

New revised third edition is a current, up-to-date manual of basic diving. Instructors who have used it claim it's the most useful and informative instructional text of its kind, a must for the beginner and a necessary reference for the expert. This edition contains the newest U.S. Navy Decompression tables as well as thirty new photos, charts and diagrams. Author Joe Strykowski's book has been approved by leading instructor organizations all over the world. **3.25**

B Model BKH—Diving For Fun (Hard Cover)

Special limited edition for instructors. Contains quiz sections for chapters 2 through 11. Attractive cloth bound hard cover. Avail. May 1, 1974 **5.95**

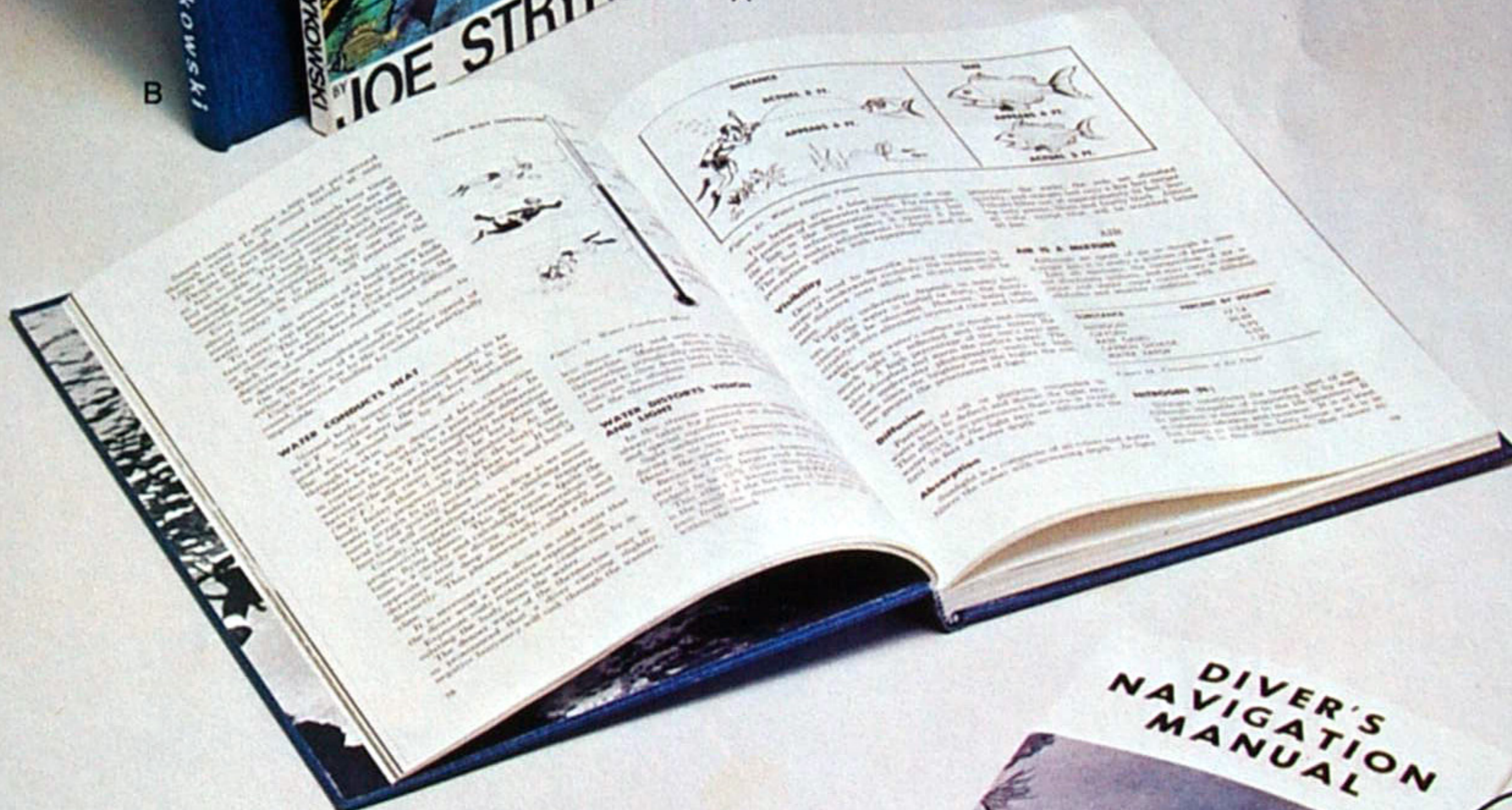

C Model UNB—Underwater Navigation Book

A complete guide for the SCUBA diver to explore his new world beyond sight of his surface point of departure. Covers use of charts, navigational techniques, air consumption calculations, cold water exposure chart, search & rescue, and log. **2.50**

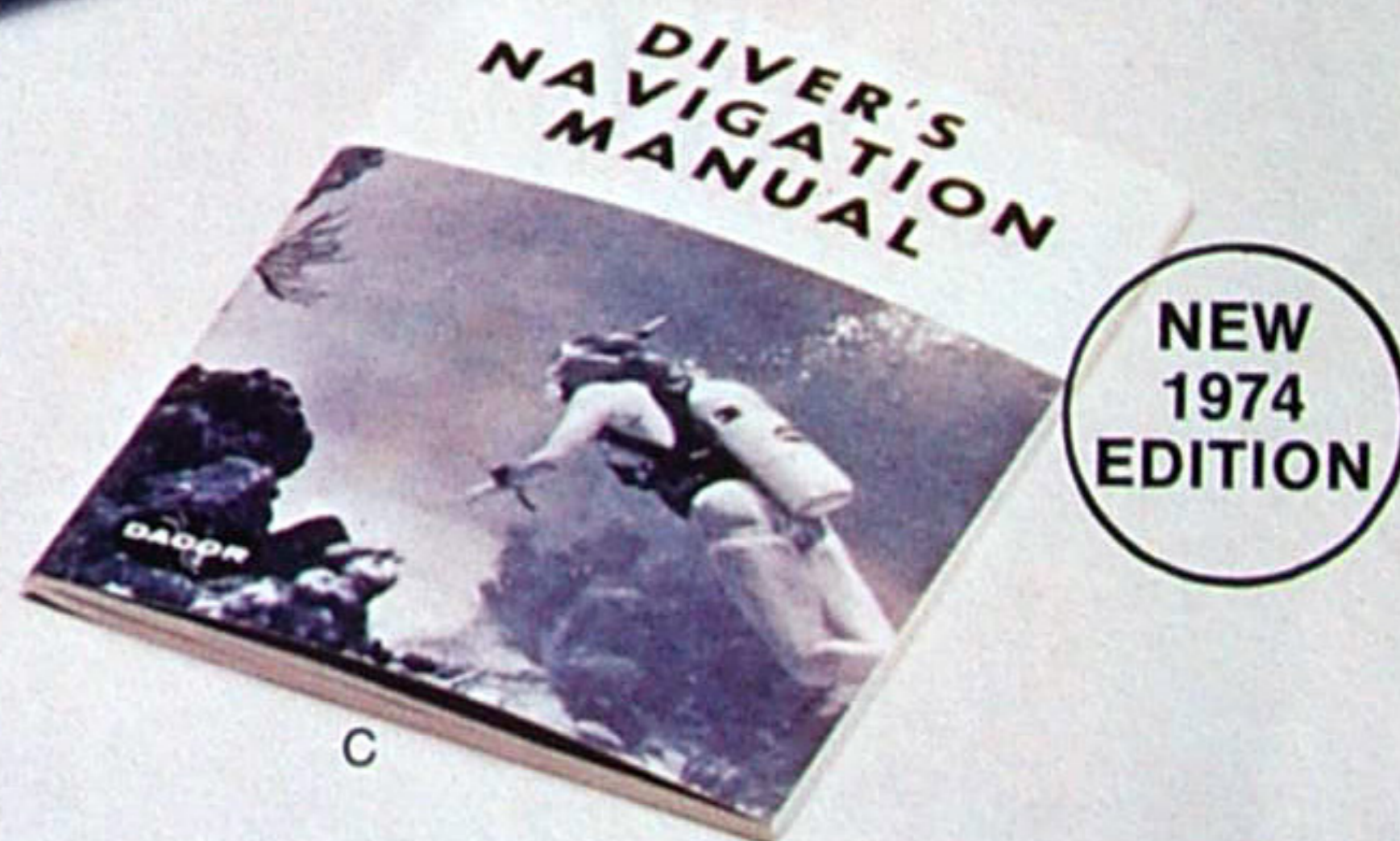

Decompression Tables

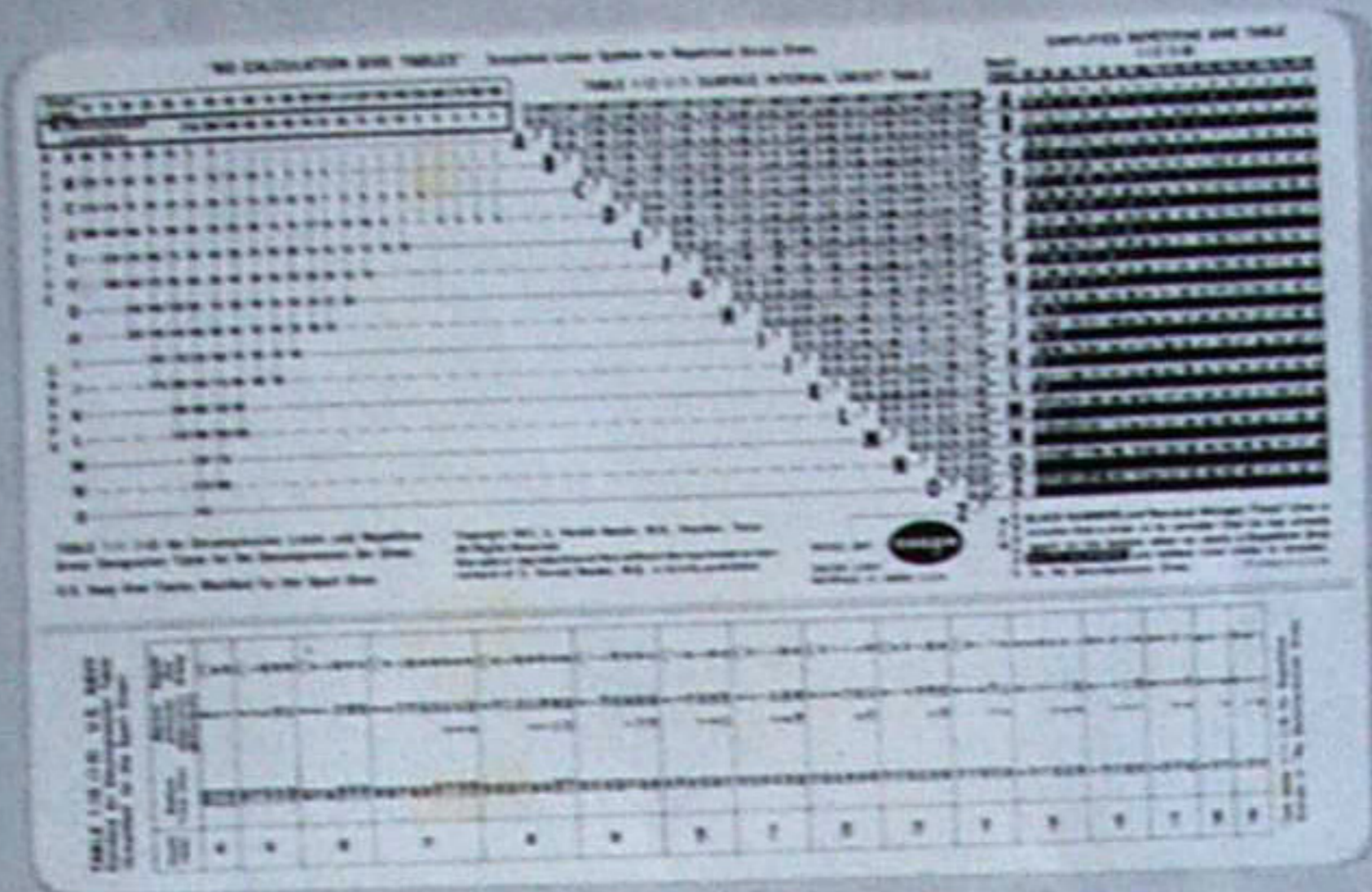

A

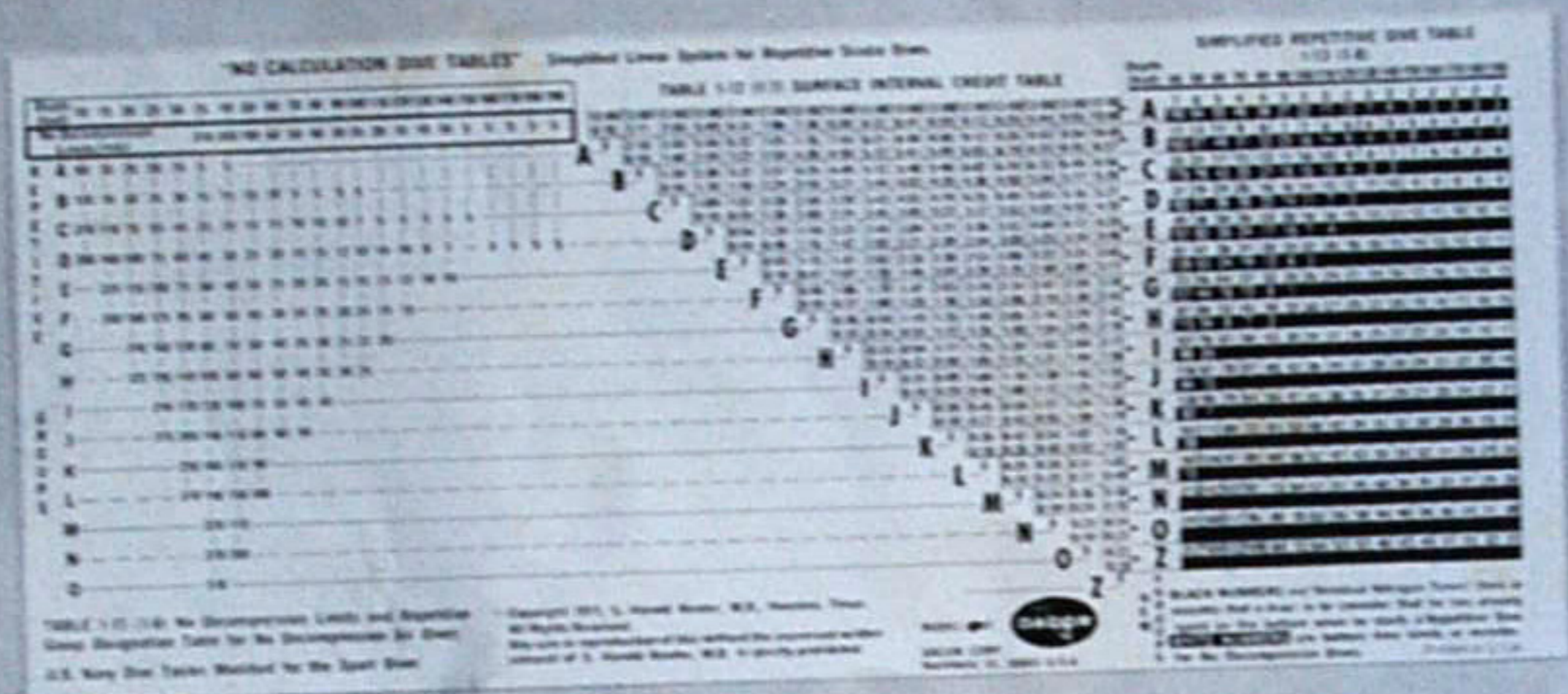

B

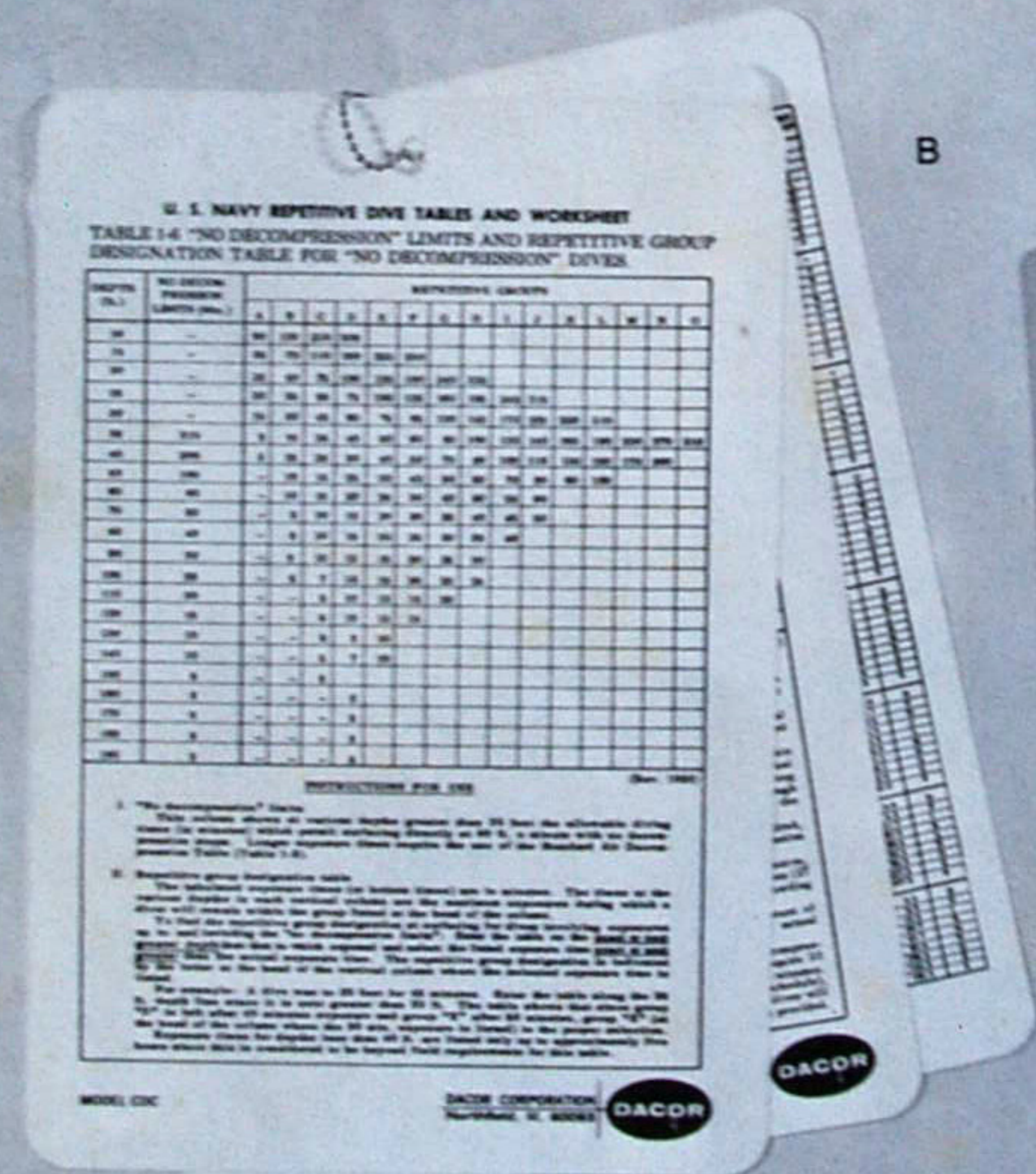

A NEW REVOLUTIONARY DECOMPRESSION SYSTEM*

Now a chart that provides direct read out with no figuring or calculation by the diver. You can get instant answers underwater or on the surface with these simplified linear tables. Based on the newest Navy Decompression Dive Tables.

*(Copyrighted 1971 by H. Reuter M.D.)

Dacor is producing models listed below:

- MODEL SNT**—Card Stock, 9 inch x 4 inch size, (not waterproof) **.25**
- MODEL PNT**—Flexible plastic, 9 inch x 4 inch size, (waterproof) **3.00**
- MODEL WNT**—Large 14" x 6", Divemaster size, flexible plastic. **4.00**
- MODEL DNT**—Pressure sensitive plastic decal, 9 inch x 8 inch size, (waterproof) **2.95**
- MODEL UNT**—Wall Chart, 3 foot x 7 foot size, (not waterproof). Specially designed for classroom and instructor demonstrations. Readable at a distance of 20 feet. **6.50**
- MODEL ZNT**—Set of two 35mm plastic mounted slides. Reproduction of Model UNT for projection. **4.95**

B MODEL DET—DECOMPRESSION CHARTS

Six compact size (6" x 8½") U.S. Navy dive table reproductions. Includes worksheet for use with grease pencil. Detachable chain and vinyl carrying case. Use in or out of water. **3.95**

C MODEL DCL—DECOMPRESSION CALCULATOR

Revolutionary slide rule type of pocket computer provides instant answers to decompression questions. Based on latest U.S. Navy dive tables. Use in or out of water. Complete with instructions and vinyl case. **5.95**

Training Aids

First Stage-Upstream, Diaphragm

Mechanical Series CM-1

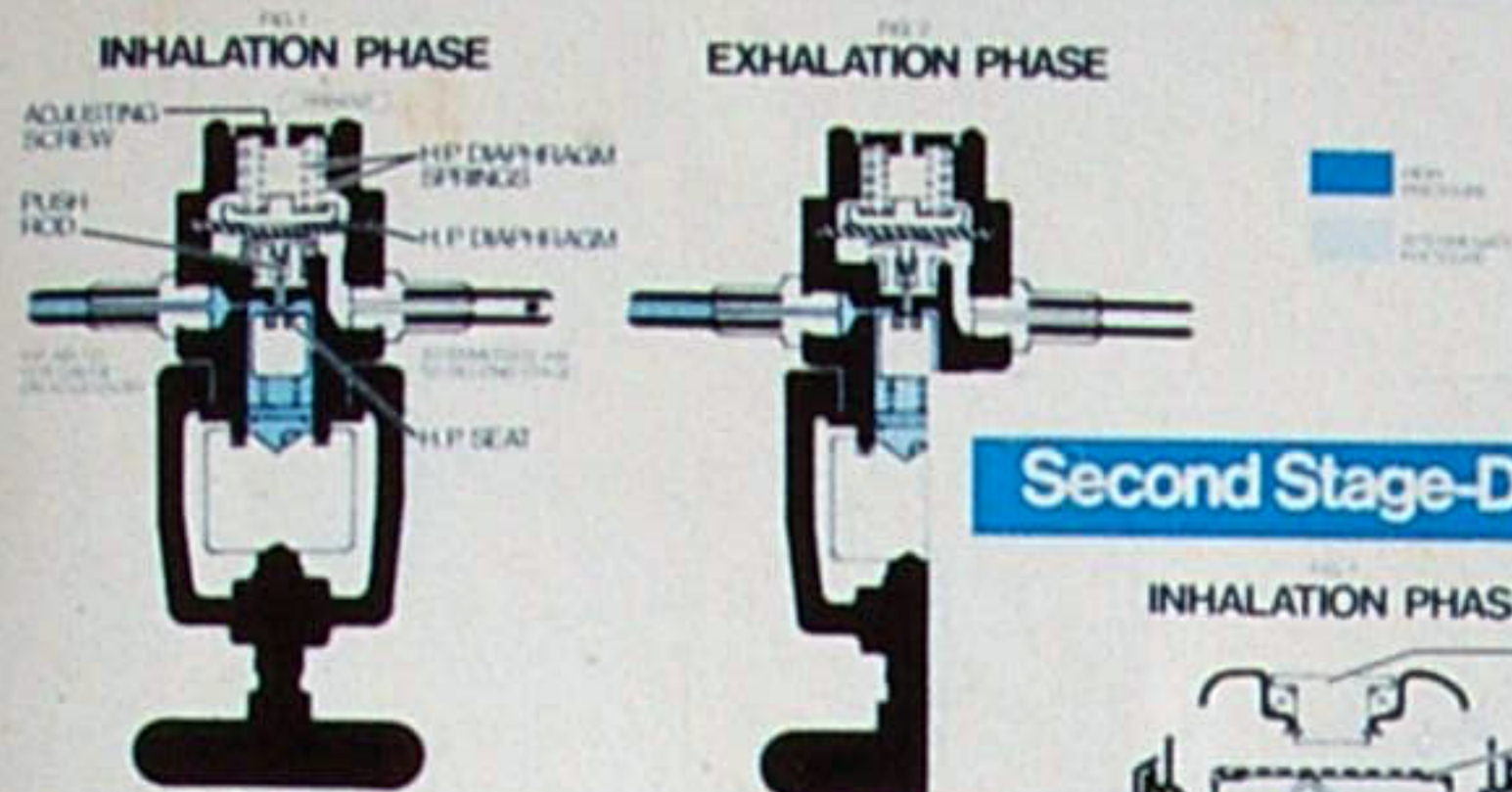

Dacor Training Aids

Second Stage-Downstream

Mechanical Series CM-1

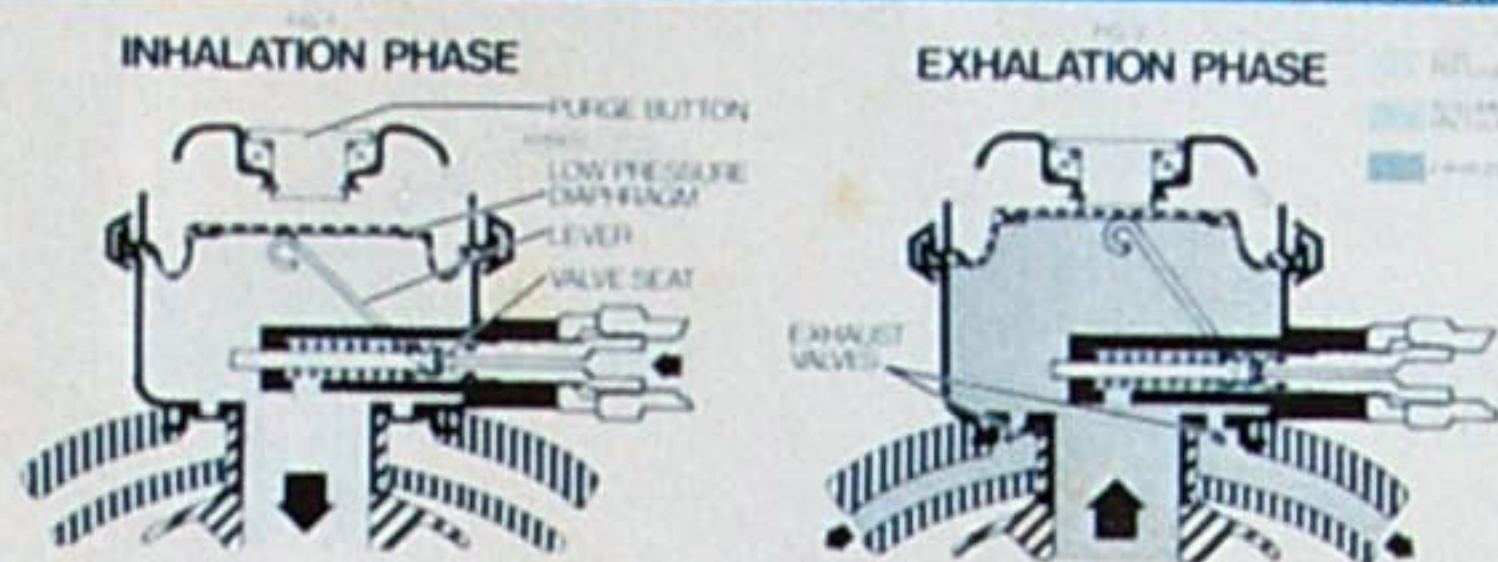

First Stage-Piston

Mechanical Series CM-1

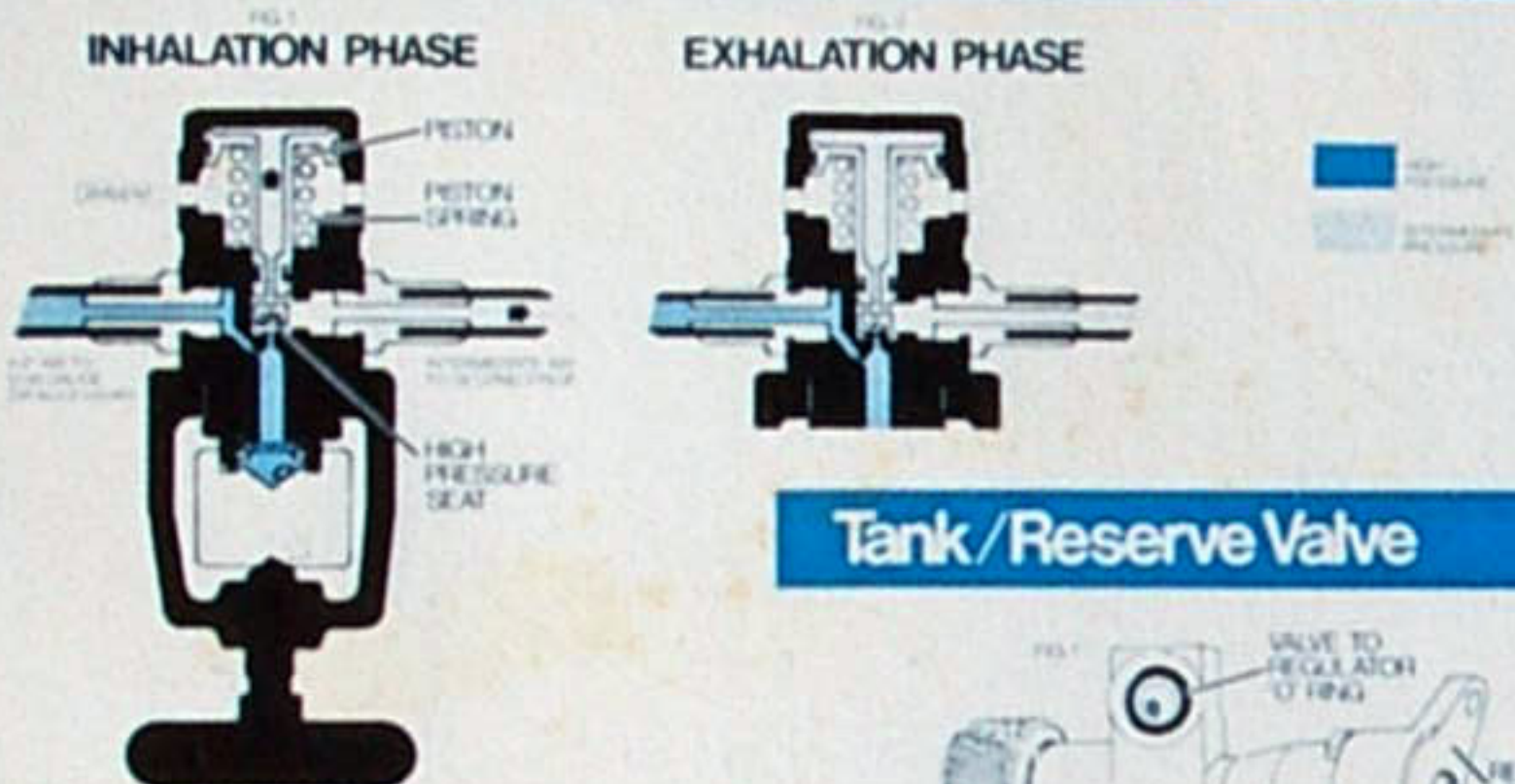

Dacor Training Aids

Tank/Reserve Valve

Mechanical Series CM-1

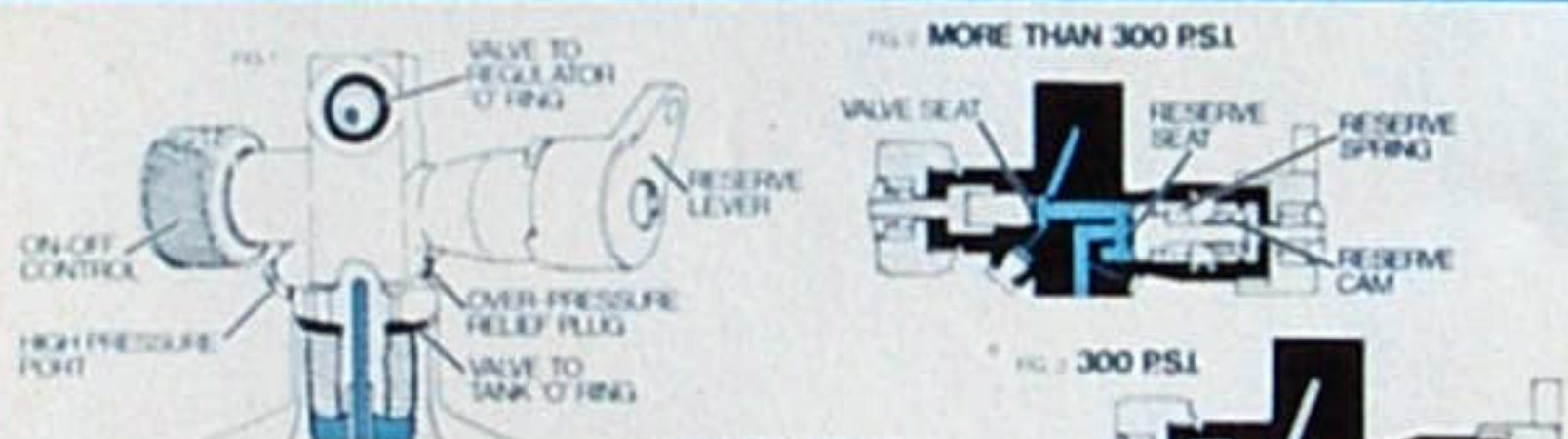

First Stage-Balanced, Diaphragm

Mechanical Series CM-1

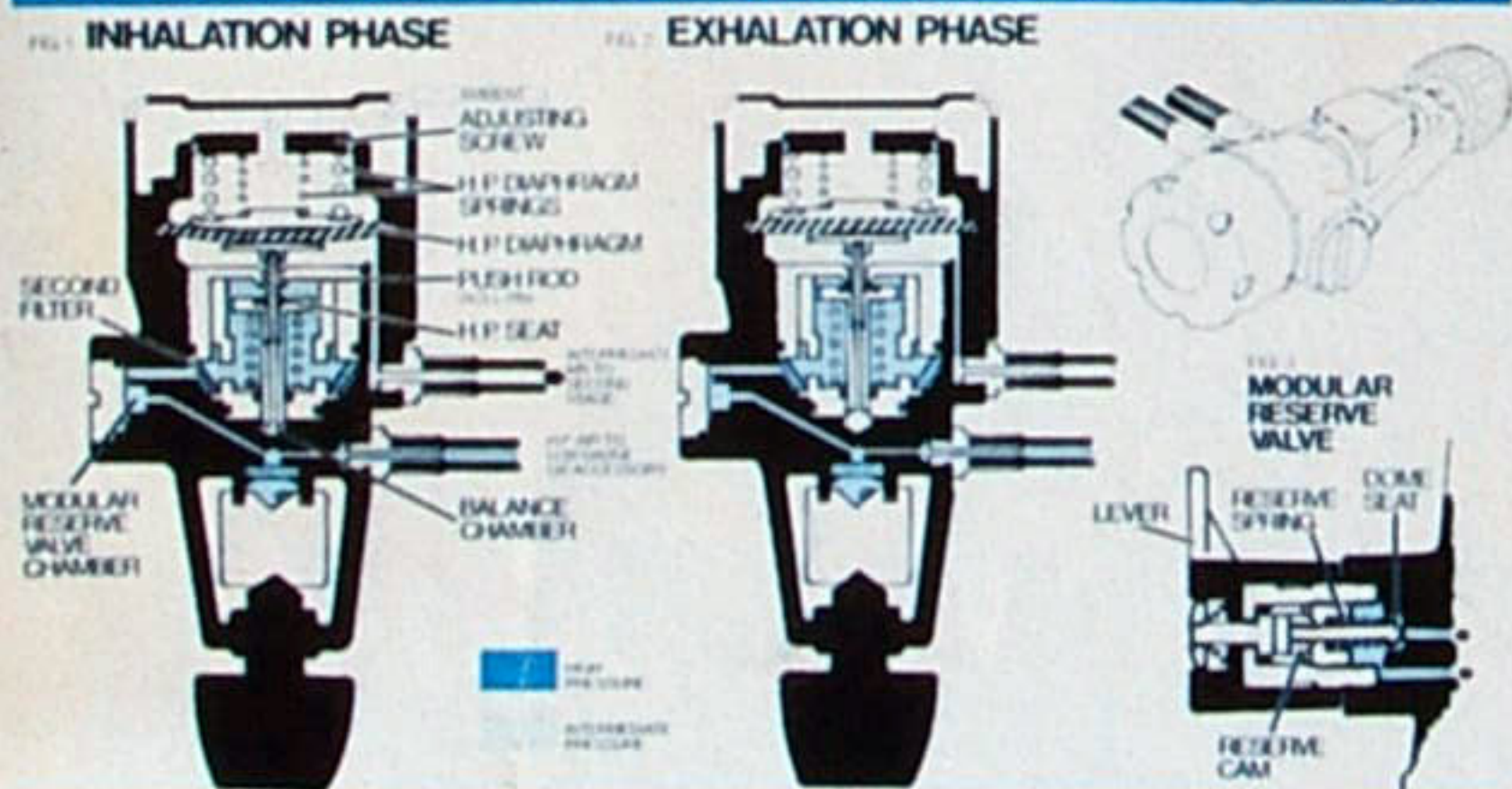

Dacor Training Aids

CM-1—INSTRUCTION CHARTS MECHANICAL SERIES

Set of 5 easy-to-read charts and outlines show and explain the functions of regulators and valves. Simple enough for the novice and detailed enough for the expert. Heavy weight card stock. Two-color keying to indicate various air pressures is constant for uniformity of interpretation. Professional 35" x 23" classroom size is easily readable at 25 ft. Instructors' lecture out-

lines included with each set. Series includes: Tank/Reserve Valve, First Stage Piston Regulator, First Stage Diaphragm Regulator, First Stage Balanced Regulator, Regulator Second Stage. **5.00**

MODEL ZM-1—Set of 5 35mm. color slides of CM-1 charts **5.00**

MODEL SM-1—Set of five 8½" x 11" charts like CM-1 for student use. Suggested lecture plan on reverse of each. **.50**



Dive Dacor

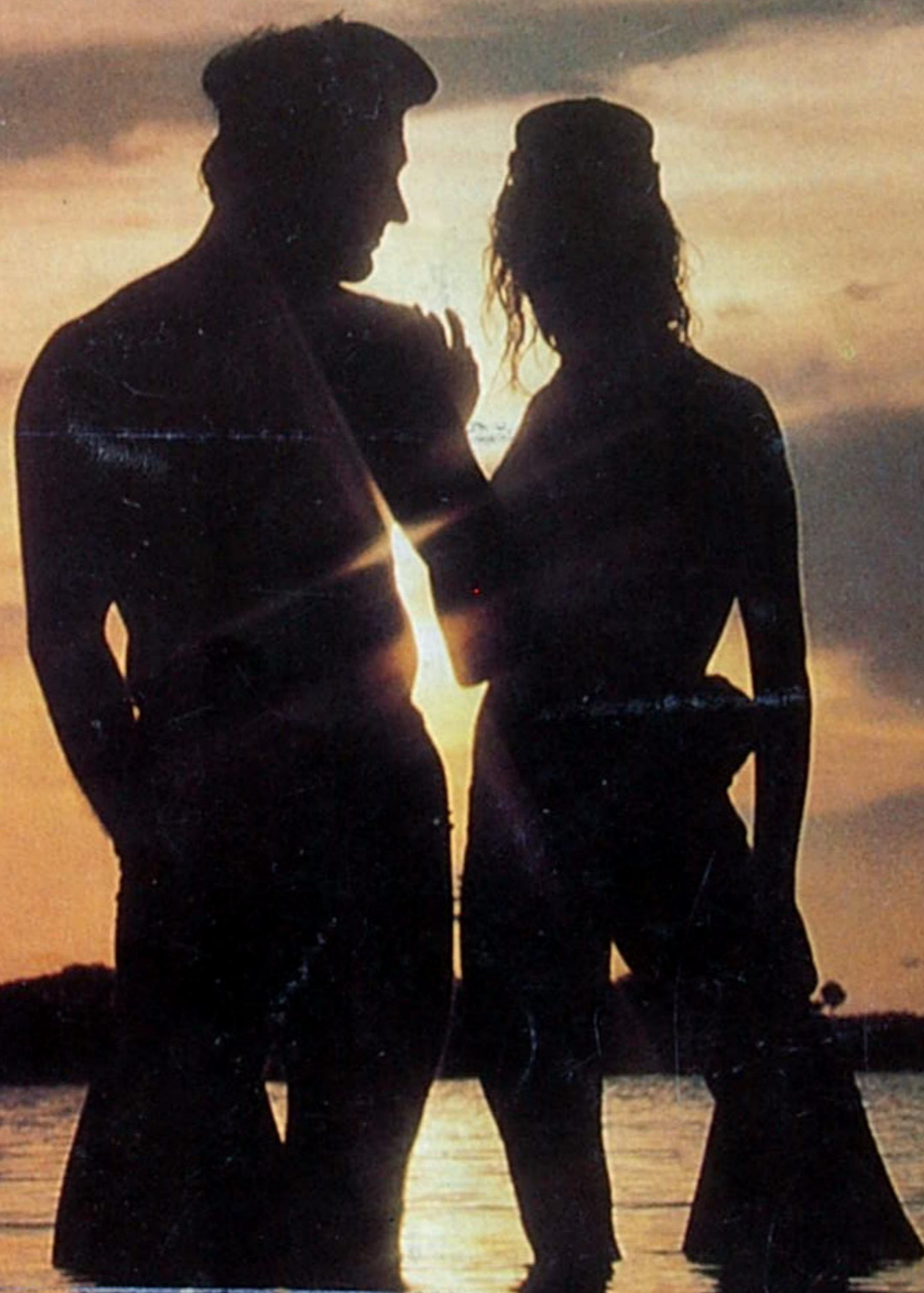

The professional's choice

Dacor Corporation **Manufacturers of Diving Equipment**
161 Northfield Road, Northfield, Illinois 60093
P.O. Box 157 **Phone: (312) 446-9555**
Cable: DIVECOR

STEVE PARK'S PRO DIVE SHOP
Just Off Eastbound Exit of Hart Bridge
OFFICE 398-1274 **RESIDENCE 765-7234**
4564 ATLANTIC BLVD., JACKSONVILLE, FLA. 32207