

# SKIN AND SCUBA DIVING EQUIPMENT

1962

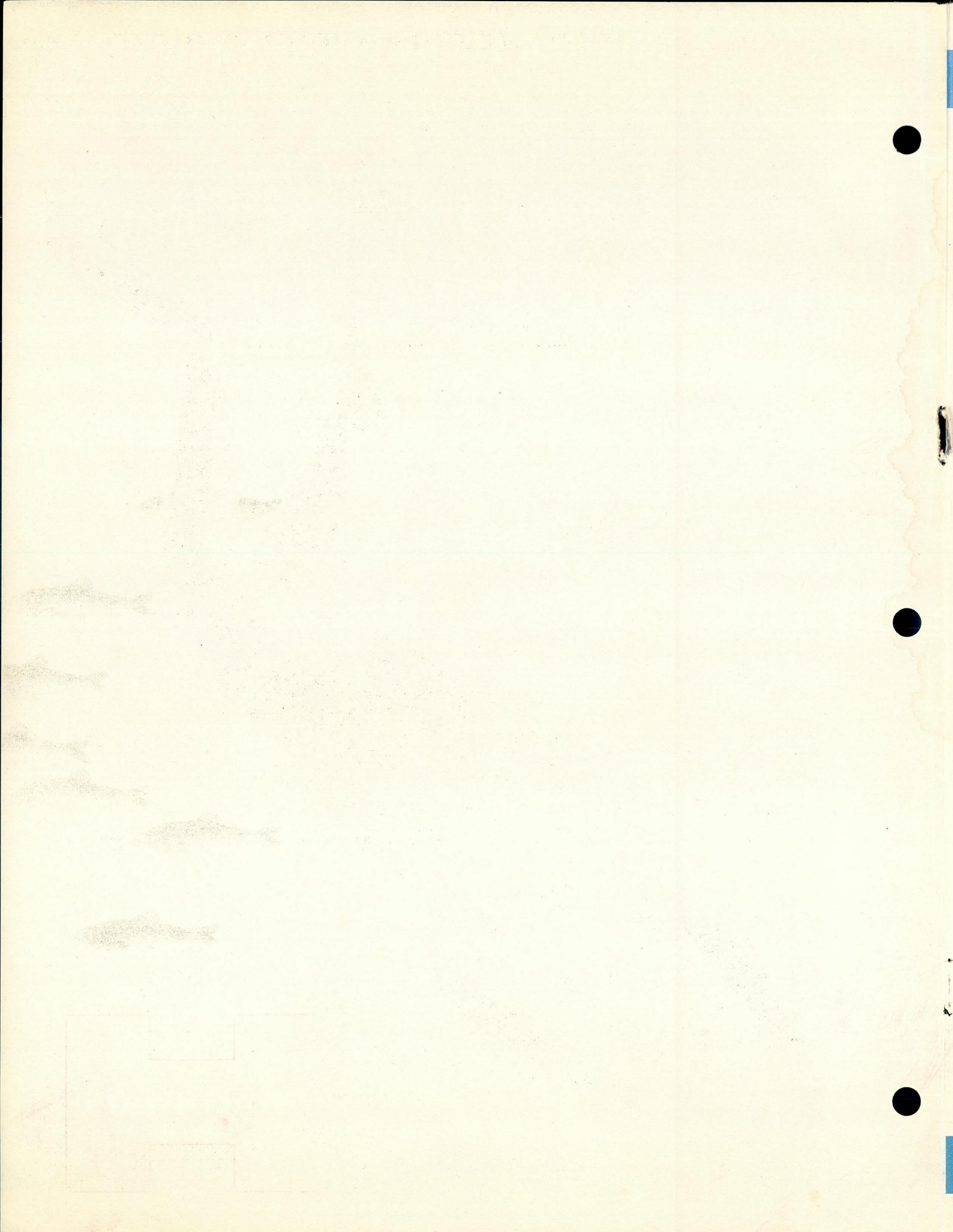



DIVE MASKS . . . . .	1-3
FINS . . . . .	4-7
SNORKELS . . . . .	8
REGULATORS . . . . .	9-12
SINGLE AND DOUBLE TANK ASSEMBLY . . . . .	13, 14
REGULATOR AND TANK COMBINATIONS . . . . .	15, 16
SCUBAPAK HARNESSSES . . . . .	17, 18
PROFESSIONAL TANK VALVES . . . . .	19
SCUBA ACCESSORIES . . . . .	20, 21, 23
SCUBAIR HOOK-UP . . . . .	22
SPEAR FISHING GUNS . . . . .	23-25
SPEARHEADS AND ACCESSORIES . . . . .	26
DIVING ACCESSORIES . . . . .	27-29
DIVING SAFETY SECTION . . . . .	30-31
SUBMARINES AND BOATS . . . . .	32
UNDERWATER EXPOSURE SUITS . . . . .	33, 34
<b>REPLACEMENT PARTS</b>	
Regulators . . . . .	35-39
Valves . . . . .	40-42
Spear Fishing Guns . . . . .	43-44
Masks, Fins and Snorkels . . . . .	45

# RESEARCH AND DEVELOPMENT



## Gustav Dalla Valle

Gustav Dalla Valle, Director of Healthways Diving Research and Development Division, is a world-famous diver and underwater pioneer. Because of a compelling feeling of responsibility toward every fellow diver, he personally tests, under the most trying conditions, every item manufactured under his control. A wealth of underwater experi-

ences in all the waters of the world and his ingenuity have been the foundation for his success in bringing to divers everywhere the safest, most advanced and most practical equipment in existence.

His life has always been devoted to the promotion of the diving sport. He is greatly responsible for introducing diving on a popular basis to the United States by presenting to the American market the first full-foot fin, the Cressi Rondine, which today is the most popular fin in the world.

Dalla Valle's international reputation and his renown as one of the outstanding pioneers and developers in the underwater field have earned the respect and the cooperation of the world's most outstanding underwater scientists.

Healthways Research and Development Division, under Dalla Valle's guidance and with the cooperation of the world's leading underwater scientists, assures that every Healthways product is the most advanced and the finest available.

## Richard E. Anderson

Richard Anderson graduated from the Sparling School of Deep Sea Diving in 1953. Because of his mechanical background, he immediately became interested in the design and development of underwater equipment. He was one of the first diving mechanical engineers in the United States who was engaged in the study and development of SCUBA apparatus.

In 1954 Richard Anderson joined Healthways Research and Development Division and has since added his experience and ability to produce the world's finest line of regulators. His development of the Scubair regulators has been an important contribution to the safety and advancement of the underwater sport.

## David R. Denis, B.S.M.E.

Mr. Denis is in charge of all engineering activities and of manufacturing and production control at Healthways. A mechanical engineer and graduate of the University of Florida, he was formerly a member of the Research Division of Standard Oil of New Jersey. His scientific contribution in the development of new products has made Healthways products the best-engineered in the world.

## Jim Christiansen

Jim Christiansen, the most famous and respected American diver, and one of the foremost advocates of diving safety education, is the developer of Healthways SCUBA-VEST. All experts agree that the SCUBA-VEST is the greatest contribution to diving safety made in many years. He was USA National Spearfishing Champion in 1956 and 1957, and Athlete of the Year in 1957. He has been Coach of the American National Spearfishing Team since 1957, and is now a full-fledged member of Healthways Research and Development Division.

## Ellis R. Cross

Master Diver E. R. Cross is a former Naval officer and former owner of the world-famous Sparling School of Deep Sea Diving. Cross was on the staff of the Commander of the Ship Salvage Unit at Bikini during the atom bomb tests. He was a delegate to the Conference for National Cooperation in Aquatics at Yale University, on Underwater Safety.

Cross is the author of Healthways "UNDERWATER SAFETY," and several technical diving books specializing in the psychology of diving, diving diseases, diving physics and diving equipment. His contributions of equipment and diving safety through the Healthways Research and Development organization are of great consequence.

## Egidio Cressi

Director General of Cressi-sub in Genoa, Italy, and a pioneer of the diving sport, Mr. Cressi is one of the first manufacturers of diving equipment. He is world-famous for his continued contribution to the underwater sport by developing new and safer products. Cressi products are known as the most advanced professional diving equipment available.

## Victor DeSanctis

Mr. DeSanctis, after many years of scientific research, produced the absolute diving safety device, THE AUTOMATIC DECOMPRESSION METER. Through this invention, Mr. DeSanctis will be honored as one of the greatest benefactors of diving safety. In collaboration with Healthways, he continues to research the science of decompression.

## Pucciarini

Mr. Pucciarini's fame in the underwater world was first established as a member of the Italian Underwater Demolition Team, during the Second World War, when he helped create the one-man and two-man submarine. Mr. Pucciarini has developed two- and four-man submarines for the United States and Allied Navies. In collaboration with the Healthways Research and Development Division, he has developed the SEA SHARK and NAUTILUS.

## Luigi Ferrari

Professor Ferrari, an associate of Egidio Cressi and Director of the Research Department of Cressi-sub in Genoa, Italy, is recognized the world over as the greatest authority on underwater propulsion. His Rondine fin design and principles have set the pace in fin development. The Super Rondine Fins are the latest creation by Professor Ferrari, in collaboration with the Healthways Research and Development Division.

# RESEARCH AND DEVELOPMENT



The world's most prominent Research and Development Division in one of their many impromptu staff meetings. (left to right: Gustav Dalla Valle, director of Research and Development, Richard E. Anderson, chief engineer—SCUBA department; David R. Denis, chief engineer—Research and Development; "Big Jim" Christiansen, technical sales supervisor.)

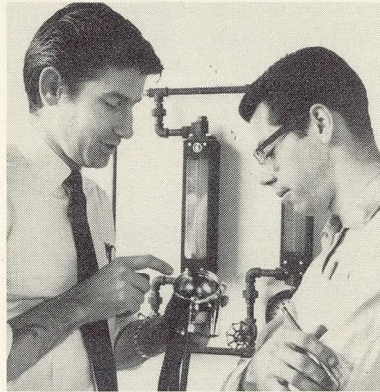

Richard E. Anderson, well known designer and chief engineer of HEALTHWAYS Scuba department goes over testing procedures with technician Bob Roberts.



David R. Denis is shown in his many daily quality control inspections.

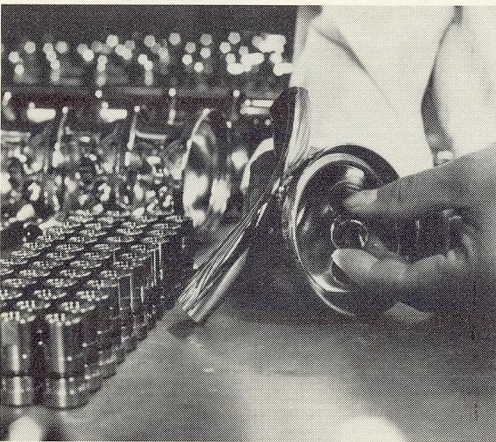

Precision engineered components being assembled into the famous SCUBAIR second stage.



Chief engineer, David R. Denis, checks a portion of the second stage assembly line for SCUBAIR single hose regulators.

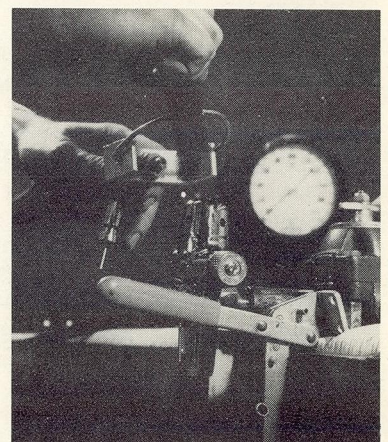

A portion of the final acceptance test given all HEALTHWAYS regulators before packaging and shipping.



"Big Jim" Christiansen and Richard E. Anderson check results in the small laboratory test chamber which can simulate depths to 1000 ft.

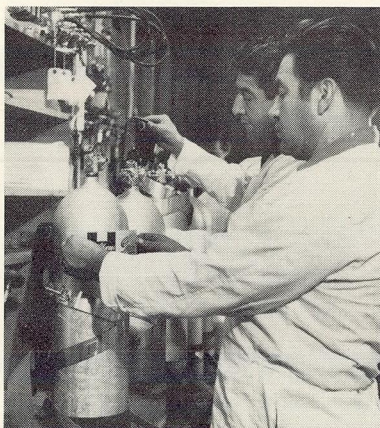

Scubapak Harness and identifying labels are put on HEALTHWAYS Scuba Tanks after thorough testing and filling.



Careful inspection before packaging of the world famous Cressi Rondine Fins assures a continuance of high quality standards.

# DIVE MASKS



**Cat. No. 1239**  
**OSTRICA JUNIOR**  
Retail \$3.95

The only professionally designed, high quality mask for smaller faces. The Ostrica Junior and Ostrica Bantam are made of yellow rubber and equipped with "Lens-Lock" band and tempered glass safety lens.

**Cat. No. 1240**  
**OSTRICA BANTAM**  
Retail \$3.50

## The PINOCCHIO PROFESSIONAL



**Cat. No. 1243**  
**THE PINOCCHIO PROFESSIONAL "MODEL 1962"**  
**PROFESSIONAL BLACK NEOPRENE**  
Retail \$8.95

The most successful of any mask, now made of black neoprene rubber which resists aging and is impervious to salt water and the elements. Accepted and used by Underwater Demolition Teams everywhere and by the world's leading professional and sport divers. Because of minimum air displacement, the Pinocchio Mask will provide up to 25% greater diving depth. The nose design allows easy and efficient compensation of underwater pressure on the ears. The tempered glass safety lens with the chrome plated brass "Lens-Lock" band is positioned to provide the fullest panoramic vision. The double feather edge insures an absolute leak proof seal.



**Cat. No. 1201**  
**AQUA CHAMP SPECIAL**  
**BLUE**  
Retail \$1.00

This popular junior mask is a well fitting, quality blue rubber mask with exclusive bend-edge design and clear styrene lens.



**Cat. No. 1202**  
**AQUA CHAMP SENIOR**  
**BLUE**  
Retail \$1.50

Leading in popularity, this well fitting round mask features quality blue rubber with a clear, round shatterproof lens.

See page 45 for replacement parts

Healthways presents the original designs in masks that lead the field in style, construction and performance. Created by Peche-Sport, Marseilles, France, the originators of the Panoramic and compensating features.

## The ESPADON



**Cat. No. 1220**  
**ESPADON**  
FRENCH BLUE  
**Retail \$3.95**

**Cat. No. 1250**  
**ESPADON**  
YELLOW  
**Retail \$3.95**

**Cat. No. 1270**  
**ESPADON**  
PROFESSIONAL BLACK  
**Retail \$3.95**

A high quality professional mask designed primarily for smaller faces. The Espadon features light weight construction with a comfortable feather edge fit. French blue, yellow or professional black rubber, "Lens-Lock" band and tempered glass safety lens.

## The PANORAMIQUE

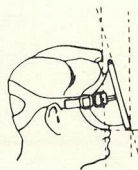

**Cat. No. 1222**  
**PANORAMIQUE**  
"WIDE-ANGLE"  
FRENCH BLUE  
**Retail \$4.95**

**Cat. No. 1252**  
**PANORAMIQUE**  
"WIDE-ANGLE"  
YELLOW  
**Retail \$4.95**

**Cat. No. 1272**  
**PANORAMIQUE**  
"WIDE-ANGLE"  
PROFESSIONAL BLACK  
**Retail \$4.95**

The exclusive design of the Panoramique "Wide-Angle," the world's most popular mask, brings the tempered safety glass lens closer to the eyes at a slant that offers undistorted vision over a wider range. The contour strap and feather edge seal of the mask make a comfortable, water-tight fit. French Blue, Yellow or Professional Black rubber, stainless steel "Lens-Lock" band and tempered glass safety lens.

## The COMPENSATOR<sup>®</sup>

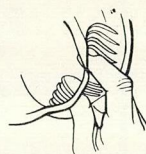

**Cat. No. 1223**  
**COMPENSATOR**  
FRENCH BLUE  
**Retail \$5.95**

**Cat. No. 1253**  
**COMPENSATOR**  
YELLOW  
**Retail \$5.95**

**Cat. No. 1273**  
**COMPENSATOR**  
PROFESSIONAL BLACK  
**Retail \$5.95**

Combining the outstanding features of all the world famous French Masks, The Compensator with its feather edge seal offers a perfect fit, the wide angle vision of the Panoramique, PLUS the exclusive finger wells that provide an easy grasp of the nose to compensate water pressure on the ears. French Blue, Yellow and Professional Black rubber, stainless steel "Lens-Lock" band and tempered glass safety lens.

See page 45 for replacement parts

# DIVE MASKS

## The PANORAMIQUE Clear-Ease

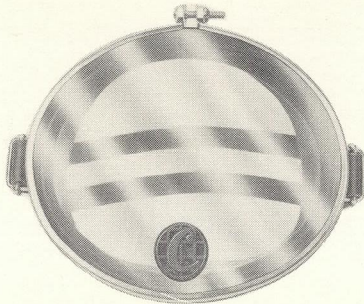

Pat. Pending

**Cat. No. 1224**  
**PANORAMIQUE "CLEAR-EASE"**  
 FRENCH BLUE  
 Retail \$5.95

The exclusive design of the Panoramique "Wide-Angle" with the proven "Clear-Ease" water purging valve, brings the tempered glass safety lens closer to the eyes at a slant that offers undistorted vision over a wider range. The contour strap and feather edge seal of the mask make a comfortable fit. French Blue rubber, stainless steel "Lens-Lock" band and tempered glass safety lens.

## The STABILIZATOR Clear-Ease

® A.S.F.A.C.E.M. product



Pat. Pending



**Cat. No. 1261**  
**STABILIZATOR "CLEAR-EASE"**  
 PROFESSIONAL BLACK  
 Retail \$6.95

Another Healthways original from the developers of the world's most successful masks.

Simplicity, efficiency and absolute safety are the outstanding features of The Stabilizator Mask. Combines the Healthways original pressure compensation finger wells and the absolutely foolproof non-return valve to clear your mask.

## The PROFESSIONAL



**Cat. No. 1211**  
**PROFESSIONAL DELUXE**  
 AMBER GUM RUBBER  
 Retail \$3.95

The Professional Mask with double strength glass lens offers extra-heavy duty construction in Amber Gum rubber that guarantees maximum comfort and seal.

See page 45 for replacement parts

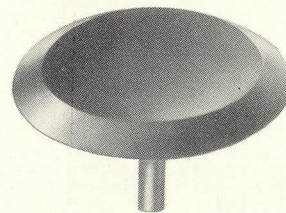

**Cat. No. 1261-06**  
**"CLEAR-EASE" VALVE**  
 Retail \$ .25



**Cat. No. 1243-07**  
**CRESSI "CLEAR-EASE" VALVE**  
 Retail \$2.00



# Rondine Fins

Created by the most renowned manufacturer of underwater sports equipment, the Cressi Rondine fins have worldwide acceptance as the finest in design, construction, fit and performance. Cressi Rondine fins are the most copied but never duplicated fins in the entire history of underwater sports.



## The Rondine Junior

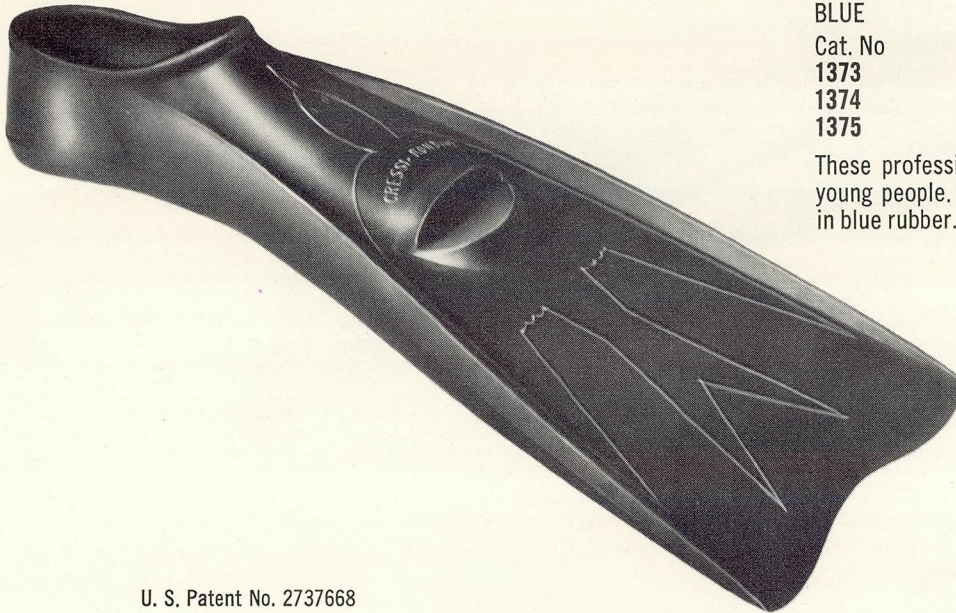

BLUE

Cat. No

1373

1374

1375

Shoe Size

2 - 3

3 - 4

4 - 5

Retail

\$5.95

5.95

5.95

These professional type fins were especially created for young people. Exceptionally light weight and comfortable in blue rubber.

U. S. Patent No. 2737668

## The Rondine Adjustable



BLUE

Cat. No.

1381

1382

1383

Shoe Size

1 - 5 (Small)

5 - 10 (Medium)

10 - 14 (Large)

Retail

\$5.95

5.95

5.95

The new Cressi Rondine Adjustable fin was created for the discriminating diver who prefers an adjustable strap. The comfortable contoured strap and the safety locking buckle plus the exclusive Cressi Rondine fin blade design make this the finest adjustable fin in the world.

U. S. Patent No. 2737668

See page 45 for replacement parts

LOS ANGELES, CALIF. • CHICAGO, ILL. • PENNSAUKEN, N. J.

Healthways

# RONDINE FINS

Created by the most renowned manufacturer of underwater sports equipment, the Cressi Rondine fins have worldwide acceptance as the finest in design, construction, fit and performance. Cressi Rondine fins are the most copied but never duplicated fins in the entire history of underwater sports.



## The GENOA

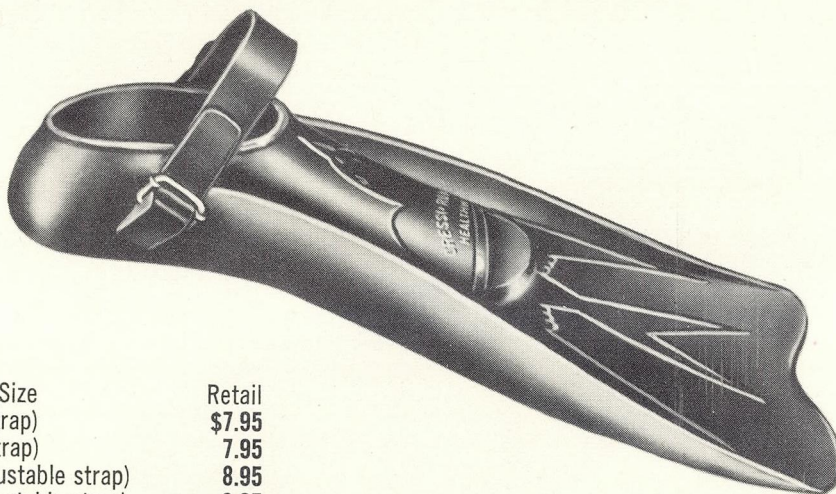

### PROFESSIONAL BLACK

Cat. No.	Shoe Size	Retail
1330	5 - 7 (without strap)	\$7.95
1331	7 - 9 (without strap)	7.95
1334	9 - 11 (with adjustable strap)	8.95
1335	11 - 13 (with adjustable strap)	9.95

The original black rubber fin that has become a world-wide leader in popularity. The Genoa is scientifically designed to provide the maximum propulsion from its fin tip and side rigidity and at the same time offer form fitting comfort.

U. S. Patent No. 2737668

## The MEDITERRANEAN



### BLUE

Cat. No.	Shoe Size	Retail
1350	5 - 7	\$10.95
1351	7 - 9	10.95
1352	9 - 11	10.95
1353	11 - 13	11.95

Made of Cressi floating blue rubber compound, combines the comfort, fin tip rigidity and lightness in weight desired by everyone.

See page 45 for replacement parts

U. S. Patent No. 2737668

# RONDINE FINNS

Created by the most renowned manufacturer of underwater sports equipment, the Cressi Rondine fins have worldwide acceptance as the finest in design, construction, fit and performance. Cressi Rondine fins are the most copied but never duplicated fins in the entire history of underwater sports.



## The GARIBALDI

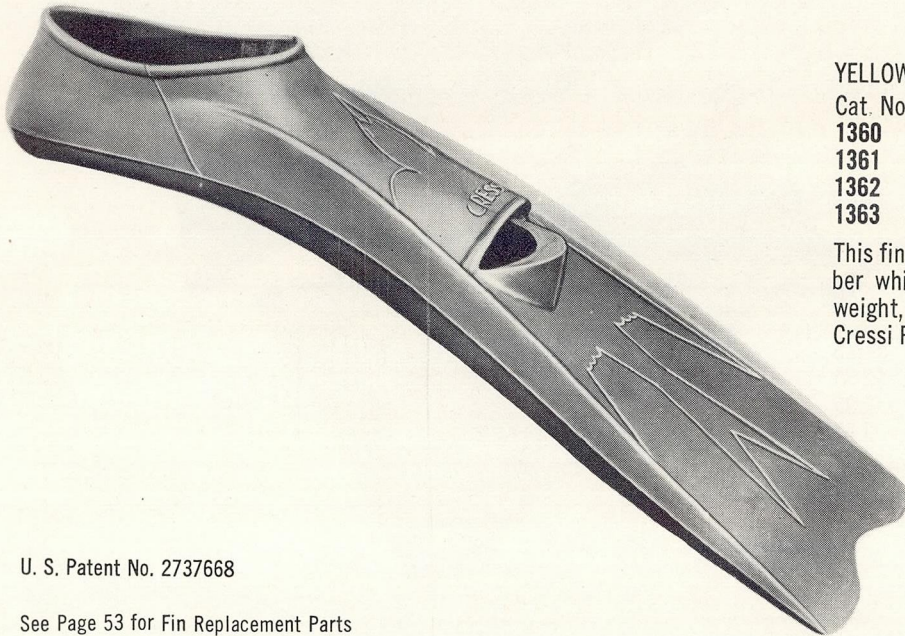

YELLOW

Cat. No.	Shoe Size	Retail
1360	5 - 7	\$11.95
1361	7 - 9	11.95
1362	9 - 11	11.95
1363	11 - 13	11.95

This fin is made of a special floating compound yellow rubber which allows easy identification. Exceptionally light weight, with fin tip rigidity and all the advantages of the Cressi Rondine fin.

U. S. Patent No. 2737668

See Page 53 for Fin Replacement Parts

## FIXE-PALME



PROFESSIONAL BLACK

Cat. No.	Shoe Size	Retail
1370	7 - 11 (medium)	\$1.75
1371	9 - 16 (large)	1.75

A universal strap for absolute fin security. Holds any closed-heel type fin to your foot under the most turbulent conditions. The fin is held in three places—instep, arch and heel. Prevents heel of fin from slipping off.



See page 45 for replacement parts

LOS ANGELES, CALIF. • CHICAGO, ILL. • PENNSAUKEN, N. J.



# FINS and ACCESSORIES

## WATER DOGS

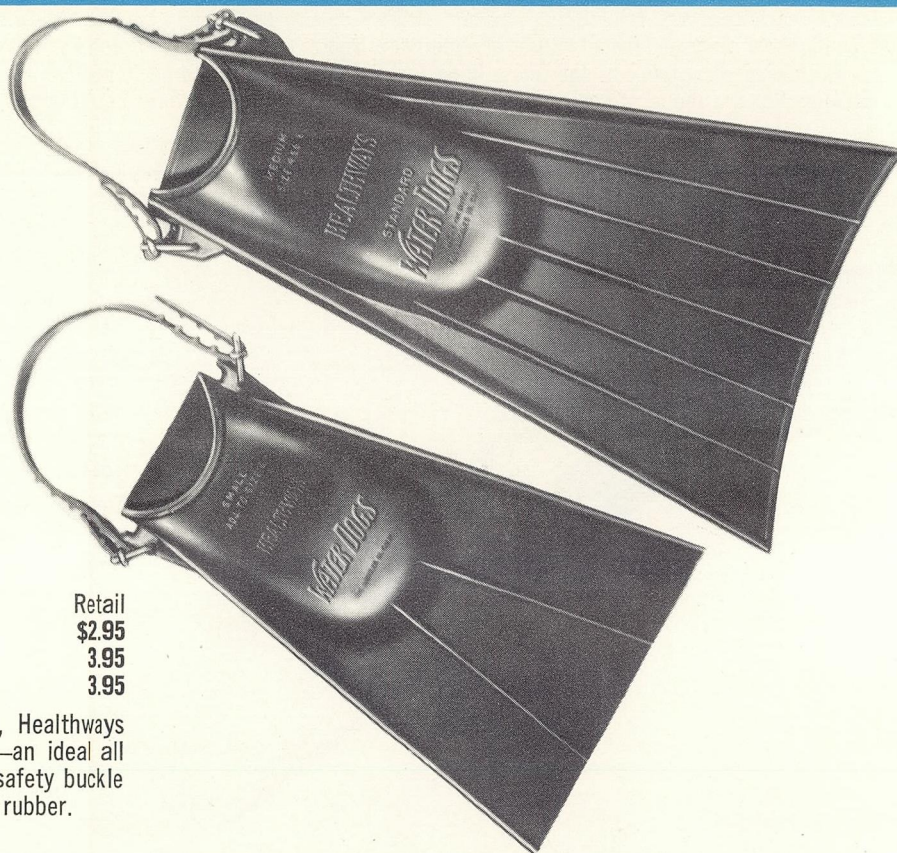

BLUE	Shoe Size	Retail
Cat. No. 1302	Adjustable to size 6	\$2.95
1303	4 - 8	3.95
1304	8 - 13	3.95

Combining quality design and appearance, Healthways Water Dogs offer durability and lightness—an ideal all around fin with a fully adjustable non-slip safety buckle and strap. Molded of special compound blue rubber.

## The RONDINE Miniature



Cat. No. 1237  
**CRESSI MINIATURE RONDINE  
FINS AND MASK SET**  
BLUE  
Retail \$.95

These detail scale miniatures of the real thing are much sought after momentos. A natural for premiums or promotions.

See page 45 for replacement parts

U. S. Patent No. 2737668

*Healthways*

LOS ANGELES, CALIF. • CHICAGO, ILL. • PENNSAUKEN, N. J.

# SNORKELS

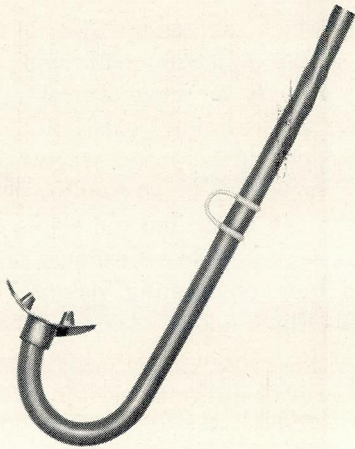

**Cat. No. 1403**

**SEA SCOUT**

**Retail \$1.00**

Straight professional type snorkel of rigid polyethylene with a soft mouthpiece.

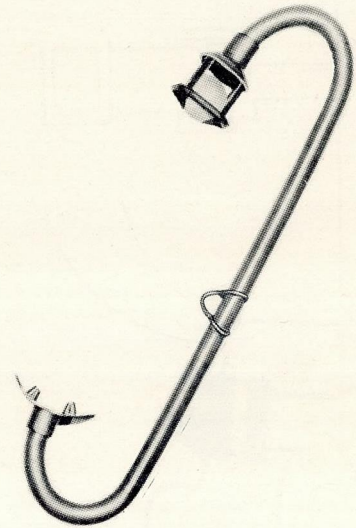

**Cat. No. 1405**

**SEA DIVE STANDARD**

**Retail \$1.00**

Cage and mouthpiece are molded of soft vinyl material.



**Cat. No. 1430**

**CRESSI DELFINO**

**Retail \$1.95**

Features one piece rubber elbow and mouthpiece, rigid blue elastic center pipe and a flexible upper section of black gum rubber.



**Cat. No. 1432**

**HAITI PROFESSIONAL**

**Retail \$1.95**

The choice of professional divers in both style and construction, the Haiti Professional is made of the finest quality black rubber and equipped with Cat. No. 1432-07 Professional Snorkel Mouthpiece.

See page 45 for replacement parts

# REGULATORS

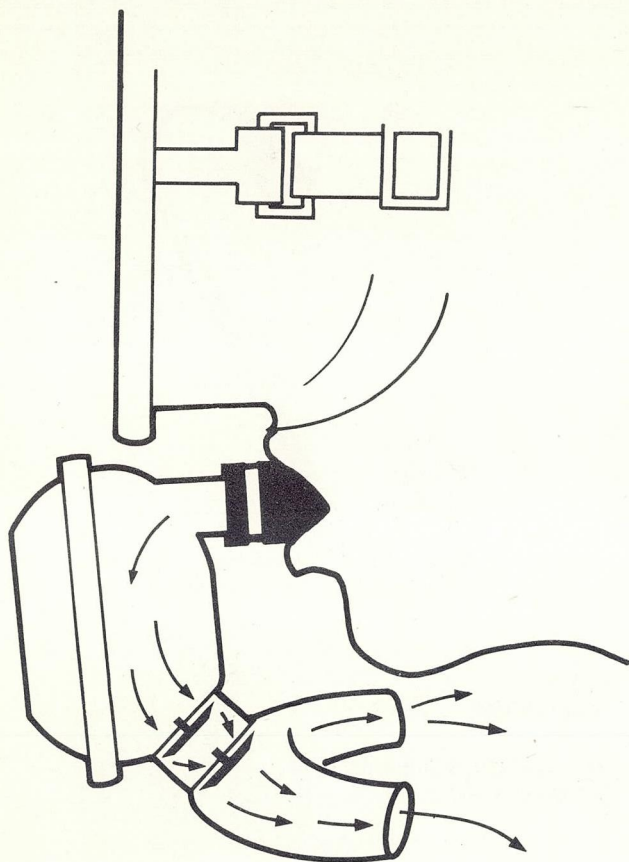

## THE SAFEST AND MOST EFFICIENT SECOND STAGE OF ANY SINGLE HOSE REGULATORS

A completely new and unique double exhaust valve which assures the diver of an absolute dry air supply under all conditions. A revolutionary new velocity air flow control— gives the diver “booster breathing” easily and comfortably at any depth. The second stage housing features a heavy chrome finish over brass and is impervious to salt water and the elements. Healthways original contoured air exhaust prevents air bubbles from obstructing vision. The well-proven “Quik-Klip” allows immediate removal of the cover to facilitate inspection and maintenance and insures a positive diaphragm seal. A swivel joint connects the high test nylon and neoprene hose to the second stage. All air connections have leak-proof “O” ring seals. A recessed snag-proof clearing button in the center of the second stage activating the diaphragm enables the diver to clear water from the unit instantly.

Pat. Pending

## SCUBA-STAR



Cat. No. 1664  
Retail \$32.50

## SCUBAIR

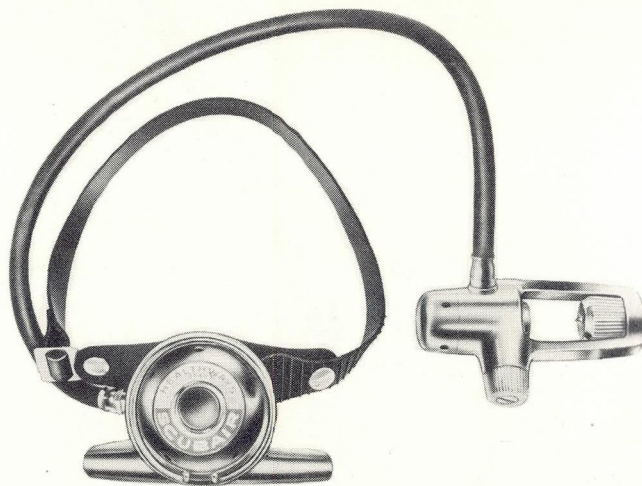

Cat. No. 1665  
Retail \$42.50

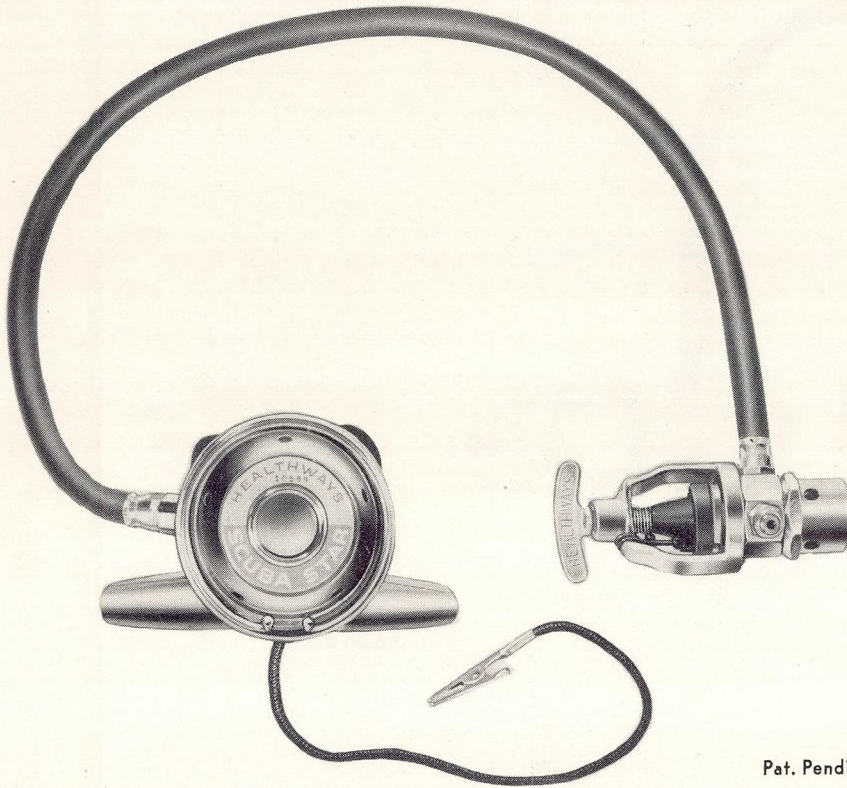

Cat. No. 1664  
**SCUBA-STAR SINGLE HOSE  
 TWO STAGE REGULATOR**  
 Retail \$32.50

Pat. Pending

## FIRST STAGE

The well-proven first stage with only one moving part and simplicity of operation and maintenance make the Scuba-Star the outstanding unit in its price class. A depth compensated automatic air reserve valve has been engineered into the first stage. All air connections have leak-proof "O" ring seals. A safety relief valve is incorporated into the first stage which eliminates the possibility of over-pressurizing the regulator. (This safety relief valve is sometimes referred to as a "third stage" in a two stage regulator.)

## SECOND STAGE

A completely new and unique double exhaust valve which assures the diver of an absolute dry air supply under all conditions. The second stage housing features a heavy chrome finish over brass and is impervious to salt water and the elements. Healthways original contoured air exhaust prevents air bubbles from obstructing vision. The well-proven "Quik-Klip" allows immediate removal of the cover to facilitate inspection and maintenance and insures a positive diaphragm seal. A swivel joint connects the high test nylon and neoprene hose to the second stage. All air connections have leak-proof "O" ring seals. A recessed snag-proof clearing button in the center of the second stage activating the diaphragm enables the diver to clear water from the unit instantly.

See Page 35 & 36 for Replacement Parts

# SCUBAIR

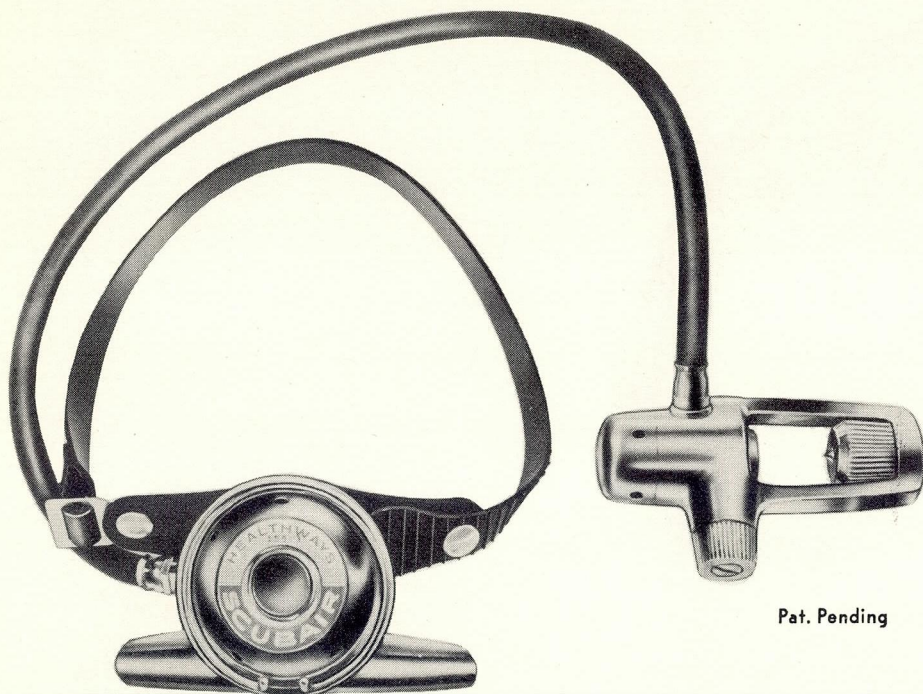

Pat. Pending

Cat. No. 1665

**SCUBAIR SINGLE HOSE  
TWO STAGE REGULATOR**

Developed by Richard E. Anderson

Retail \$42.50

## FIRST STAGE

The Scubair regulator, the most widely acclaimed and accepted SCUBA in the history of self-contained diving, features the most efficient and functional design of any single hose regulator. A manually operated automatic air reserve control switch enables the diver to adjust his regulator for the automatic depth compensated reserve—or the “J restrictor” position when the regulator is to be used with a constant air reserve valve. An automatic depth compensated air reserve is activated by turning the external control wheel to the “K restrictor” position. This means instead of having to change the restrictors in the high pressure block, this function can be performed simply with a twist of your fingers. The new internal yoke screw eliminates the conventional wing nut and provides an easily operated snag-proof means of attaching the regulator. Finger tip control is all that is necessary. The well-proven first stage with only one moving part and its simplicity all help to make the Scubair the safest and most functional SCUBA. It contains a high pressure plug which can be removed and the Submersible Scubair Gauge installed to enable the diver to know at all times how much air remains in the cylinder while diving.

## SECOND STAGE

A completely new and unique double exhaust valve which assures the diver of an absolute dry air supply under all conditions. A completely new demand valve mechanism, engineered to deliver more air than any diving regulator available regardless of depth is incorporated into the second stage. A balanced venturi velocity air flow control—gives the diver “booster breathing” easily and comfortably at any depth. The second stage housing features a heavy chrome finish over brass and is impervious to salt water and the elements. Healthways original contoured air exhaust prevents air bubbles from obstructing vision. The well-proven “Quik-Klip” allows immediate removal of the cover to facilitate inspection and maintenance and insures a positive diaphragm seal. A swivel joint connects the high test nylon and neoprene hose to the second stage. All air connections have leak-proof “O” ring seals. A recessed snag-proof clearing button in the center of the second stage activating the diaphragm enables the diver to clear water from the unit instantly.

See page 37–38 for replacement parts

*Healthways*

LOS ANGELES, CALIF. • CHICAGO, ILL. • PENNSAUKEN, N. J.



# SCUBA DELUXE "MODEL 1962"

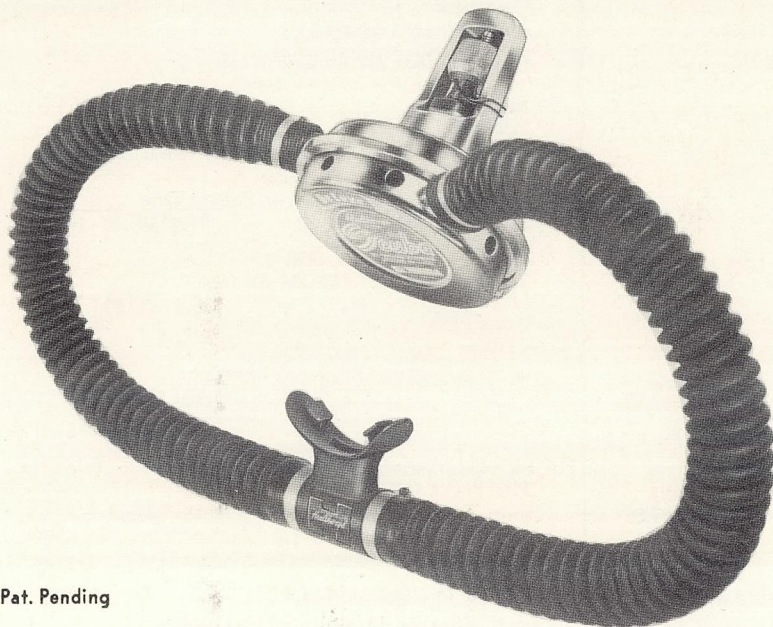

Pat. Pending

Cat. No. 1611  
SCUBA DELUXE "MODEL 1962"  
DOUBLE HOSE SINGLE STAGE REGULATOR  
Retail \$52.50

The Scuba Deluxe "Model 1962" is the most popular and dependable regulator in its class. Every integral part of this unit has been precision made and engineered to insure maximum efficiency. Only the finest chrome plated stainless steel and brass materials have been used. No possibility of corrosion, electrolysis or other chemical action. A depth compensated air reserve has been engineered into the regulator. The Model 1962 Scuba Deluxe has a completely pressure-compensated exhaling valve that assures effortless equalized exhalation in any position. A new type neoprene high test air hose is being used.

See page 39 for replacement parts

## NEW FEATURES

- VENTURI MECHANISM:** Gives effortless breathing at any depth.
- INTERNAL YOKE:** The New internal yoke screw eliminates the conventional wing nut and provides an easily operated means of attaching the regulator. Finger tip control is all that is necessary.
- CASE AND COVER:** Locked together giving a more secure attachment and providing easier assembly.

**HEAVIER CONSTRUCTION THROUGHOUT**

## UNCONDITIONAL TWO YEAR GUARANTEE

**TWO YEAR UNCONDITIONAL GUARANTEE FOR ALL 1962 HEALTHWAYS REGULATORS—THE SCUBA-STAR, THE SCUBAIR AND THE SCUBA DELUXE.**

HEALTHWAYS is the only manufacturer of SCUBA equipment to offer unconditional guarantee against defects in material and workmanship for **TWO YEARS** from date of purchase. This **TWO YEAR** guarantee is proof of the superior quality of HEALTHWAYS products. HEALTHWAYS SCUBA equipment is the best that money can buy!

LOS ANGELES, CALIF. • CHICAGO, ILL. • PENNSAUKEN, N. J.

*Healthways*

# SINGLE TANK ASSEMBLIES



## 42 CU. FT. TANK ASSEMBLIES WITH HIGH PRESSURE VALVE

### No. 1615

Includes:  
 No. 1694 - 42 Cu. Ft. Tank, Galvanized  
 No. 1443 Scubapak Harness  
 No. 1652 High Pressure Valve  
 No. 1448 Tank Boot      **Retail \$57.50**

**No. 1616** — Same as No. 1615 With Black Epoxy Coating on Tank      **Retail \$62.50**

**No. 1450** — Same as No. 1615 with No. 1445 CONTOUR SCUBAPAK HARNESS      **Retail \$62.50**

**No. 1451** — Same as No. 1450 WITH BLACK EPOXY COATING ON TANK      **Retail \$67.50**

## 42 CU. FT. TANK ASSEMBLIES WITH CONSTANT AIR RESERVE VALVE

### No. 1629

Includes:  
 No. 1694 - 42 Cu. Ft. Tank Assembly, Galvanized  
 No. 1443 Scubapak Harness  
 No. 1654 Scuba Constant Air Reserve Valve  
 No. 1448 Tank Boot      **Retail \$67.50**

**No. 1631** — Same as No. 1629 WITH BLACK EPOXY COATING ON TANK      **Retail \$72.50**

**No. 1452** — Same as No. 1629 with No. 1445 CONTOUR SCUBAPAK HARNESS      **Retail \$72.50**

**No. 1453** — Same as No. 1452 WITH BLACK EPOXY COATING ON TANK      **Retail \$77.50**



## 71.2 CU. FT. TANK ASSEMBLY WITH HIGH PRESSURE VALVE

### No. 1607

Includes:  
 No. 1602 - 71.2 Cu. Ft. Tank, Galvanized  
 No. 1443 Scubapak Harness  
 No. 1652 High Pressure Valve  
 No. 1448 Tank Boot      **Retail \$64.75**

**No. 1659** — Same as No. 1607 WITH BLACK EPOXY COATING ON TANK      **Retail \$69.75**

**No. 1462** — Same as 1607 with 1445 CONTOUR SCUBAPAK HARNESS      **Retail \$69.75**

**No. 1463** — Same as No. 1462 WITH BLACK EPOXY COATING ON TANK      **Retail \$74.75**

## 71.2 CU. FT. TANK ASSEMBLY WITH CONSTANT AIR RESERVE VALVE

### No. 1627

Includes:  
 No. 1602 - 71.2 Cu. Ft. Tank, Galvanized  
 No. 1443 Scubapak Harness  
 No. 1654 Constant Air Reserve Valve  
 No. 1448 Tank Boot      **Retail \$84.75**

**No. 1660** — Same as No. 1627 WITH BLACK EPOXY COATING ON TANK      **Retail \$89.75**

**No. 1464** — Same as 1627 with 1445 CONTOUR SCUBAPAK HARNESS      **Retail \$89.75**

**No. 1465** — Same as No. 1464 WITH BLACK EPOXY COATING ON TANK      **Retail \$94.75**

## BARE TANKS



**No. 1694**  
 42 CU. FT. TANK 1880 P.S.I., GALVANIZED WITH VALVE  
**Retail \$40.00**

**No. 1695** — Same as No. 1694 WITHOUT BLACK EPOXY COATING ON TANK  
**Retail \$45.00**

**No. 1602**  
 71.2 CU. FT. TANK, 2250 P.S.I., GALVANIZED WITHOUT VALVE  
**Retail \$47.50**

**No. 1658** — Same as No. 1602 WITH BLACK EPOXY COATING ON TANK  
**Retail \$52.50**

## ECONOMY TANK ASSEMBLIES

### No. 1474

Includes:  
 No. 1602 - 71.2 Cu. Ft. Tank  
 No. 1600 Harness  
 No. 1654 Scuba Constant Air Reserve Valve  
**Retail \$75.00**

### No. 1475

Includes:  
 No. 1694 - 42 Cu. Ft. Tank, Galvanized (two)  
 No. 1652 High Pressure Valve  
 No. 1654 Scuba Constant Air Reserve Valve  
 No. 1606 Two Tank Yoke Assembly  
 No. 1619 Double Tank Harness  
 No. 1448 Tank Boot (two)  
**Retail \$134.75**

# DOUBLE TANK ASSEMBLIES

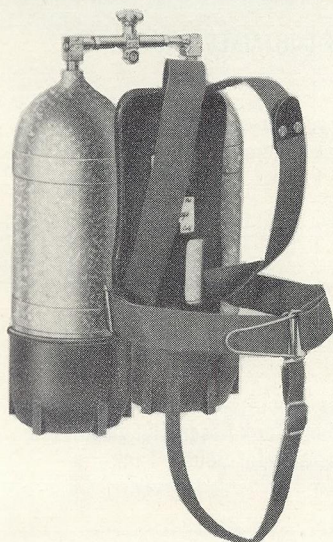

## 42 CU. FT. DOUBLE TANK ASSEMBLIES WITH HIGH PRESSURE VALVE

### No. 1454

#### Includes:

- No. 1694 - 42 Cu. Ft. Tank, Galvanized (two)
- No. 1619 Scubapak Double Tank Harness
- No. 1609 High Pressure Valve for Double Tank Assembly
- No. 1448 Tank Boot (two) **Retail \$118.00**

### No. 1455 — Same as No. 1454 WITH BLACK EPOXEY COATING ON TANKS **Retail \$128.00**

### No. 1458 — Same as No. 1454 with No. 1446 CONTOUR SCUBAPAK DOUBLE TANK HARNESS **Retail \$123.00**

### No. 1459 — Same as No. 1458 WITH BLACK EPOXEY COATING ON TANKS **Retail \$133.00**

## 42 CU. FT. DOUBLE TANK ASSEMBLY WITH CONSTANT AIR RESERVE VALVE No. 1640

### Includes:

- No. 1694 - 42 Cu. Ft. Tank, Galvanized (two)
- No. 1619 Scubapak Double Tank Harness
- No. 1653 Scuba Constant Air Reserve Valve for Double Tank Assembly
- No. 1448 Tank Boot (two) **Retail \$140.00**

### No. 1650 — Same as No. 1640 WITH BLACK EPOXEY COATING ON TANKS **Retail \$150.00**

### No. 1460 — Same as No. 1640 with No. 1446 CONTOUR SCUBAPAK HARNESS **Retail \$145.00**

### No. 1461 — Same as No. 1460 WITH BLACK EPOXEY COATING ON TANKS **Retail \$155.00**

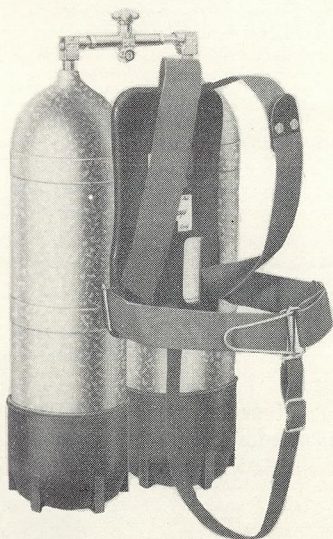

## 71.2 CU. FT. DOUBLE TANK ASSEMBLY WITH HIGH PRESSURE VALVE

### No. 1468

#### Includes:

- No. 1602 - 71.2 Cu. Ft. Tank, Galvanized (two)
- No. 1619 Double Tank Harness
- No. 1609 High Pressure Valve for Double Tank Assembly
- No. 1448 Tank Boot (two) **Retail \$133.00**

### No. 1469 — Same as No. 1468 WITH BLACK EPOXEY COATING ON TANKS **Retail \$143.00**

### No. 1470 — Same as No. 1468 with No. 1446 CONTOUR SCUBAPAK DOUBLE TANK HARNESS **Retail \$138.00**

### No. 1471 — Same as No. 1470 WITH BLACK EPOXEY COATING ON TANKS **Retail \$148.00**

## 71.2 CU. FT. DOUBLE TANK ASSEMBLY WITH CONSTANT AIR RESERVE VALVE

### No. 1648

#### Includes:

- No. 1602 - 71.2 Cu. Ft. Tank, Galvanized (two)
- No. 1619 Double Tank Harness
- No. 1653 Scuba Constant Air Reserve Valve for double Tank Assembly
- No. 1448 Tank Boot (two) **Retail \$155.00**

### No. 1644 — Same as No. 1648 WITH BLACK EPOXEY COATING ON TANKS **Retail \$165.00**

### No. 1472 — Same as No. 1648 with No. 1446 CONTOUR SCUBAPAK DOUBLE TANK HARNESS **Retail \$160.00**

### No. 1473 — Same as No. 1472 WITH BLACK EPOXEY COATING ON TANKS **Retail \$170.00**

## PROFESSIONAL BLACK TANKS

After diligent research, Healthways discovered the ultimate coating for SCUBA tanks. The baked-on EPOXEY black resin coating retards migration of oxidation . . . resists the elements and toughest handling. Dive the PROFESSIONAL way — with HEALTHWAYS SAFETY BLACK TANKS.

**ALL HEALTHWAYS BLACK EPOXY TANKS ARE FIRST GALVANIZED FOR DOUBLE PROTECTION**

# REGULATOR AND TANK COMBINATIONS

## SCUBA-STAR

### NO. 1478 SCUBA-STAR SELF-CONTAINED UNDERWATER BREATHING APPARATUS

Includes:

- No. 1664 Scuba-Star Regulator
- No. 1615 - 42 Cu. Ft. Tank Assembly, galvanized
- No. 1652 High Pressure Valve
- Complete Instructions

Retail \$90.00

### NO. 1479 SCUBA-STAR SELF-CONTAINED UNDERWATER BREATHING APPARATUS

Includes:

- No. 1664 Scuba-Star Regulator
- No. 1454 - 42 Cu. Ft. Double Tank Assembly, galvanized
- No. 1609 High Pressure Valve for Double Tank Assembly
- Complete Instructions

Retail \$150.50

## SCUBAIR

### NO. 1482 SCUBAIR SELF-CONTAINED UNDERWATER BREATHING APPARATUS

Includes:

- No. 1665 Scubair Regulator
- No. 1615 - 42 Cu. Ft. Tank Assembly, galvanized
- No. 1652 High Pressure Valve
- Complete Instructions

Retail \$100.00

### NO. 1483 SCUBAIR SELF-CONTAINED UNDERWATER BREATHING APPARATUS

Includes:

- No. 1665 Scubair Regulator
- No. 1454 - 42 Cu. Ft. Double Tank Assembly, galvanized
- No. 1609 High Pressure Valve for Double Tank Assembly
- Complete Instructions

Retail \$160.50

## SCUBA DELUXE

### "MODEL 1962"

### NO. 1494 SCUBA DELUXE SELF-CONTAINED UNDERWATER BREATHING APPARATUS

Includes:

- No. 1611 Scuba Deluxe Regulator
- No. 1615 - 42 Cu. Ft. Tank Assembly, galvanized
- No. 1652 High Pressure Valve
- Complete Instructions

Retail \$110.00

### NO. 1495 SCUBA DELUXE SELF-CONTAINED UNDERWATER BREATHING APPARATUS

Includes:

- No. 1611 Scuba Deluxe Regulator
- No. 1454 - 42 Cu. Ft. Double Tank Assembly, galvanized
- No. 1609 High Pressure Valve for Double Tank Assembly
- Complete Instructions

Retail \$170.50

# REGULATOR AND TANK COMBINATIONS

## NO. 1480 SCUBA-STAR UNDERWATER BREATHING APPARATUS

Includes:

- No. 1664 Scuba-Star Regulator
- No. 1640-42 Cu. Ft. Double Tank Assembly, galvanized
- No. 1653 Constant Air Reserve Valve for Double Tank Assembly
- Complete Instructions

Retail \$172.50

## NO. 1684 SCUBA-STAR SELF-CONTAINED UNDERWATER BREATHING APPARATUS

Includes:

- No. 1664 Scuba-Star Regulator
- No. 1627-71.2 Cu. Ft. Tank Assembly, galvanized
- No. 1654 Constant Air Reserve Valve
- Complete Instructions

Retail \$117.25

## NO. 1681 SCUBA-STAR UNDERWATER BREATHING APPARATUS

Includes:

- No. 1664 Scuba-Star Regulator
- No. 1607-71.2 Cu. Ft. Tank Assembly, galvanized
- No. 1652 High Pressure Valve
- Complete Instructions

Retail \$97.25

## NO. 1481 SCUBA-STAR UNDERWATER BREATHING APPARATUS

Includes:

- No. 1664 Scuba-Star Regulator
- No. 1648 71.2 Cu. Ft. Double Tank Assembly, galvanized
- No. 1653 Constant Air Reserve Valve for Double Tank Assembly
- Complete Instructions

Retail \$187.50

## NO. 1484 SCUBAIR UNDERWATER BREATHING APPARATUS

Includes:

- No. 1665 Scubair Regulator
- No. 1640-42 Cu. Ft. Double Tank Assembly, galvanized
- No. 1653 Constant Air Reserve Valve for Double Tank Assembly
- Complete Instructions

Retail \$182.50

## NO. 1486 SCUBAIR SELF-CONTAINED UNDERWATER BREATHING APPARATUS

Includes:

- No. 1665 Scubair Regulator
- No. 1627-71.2 Cu. Ft. Tank Assembly, galvanized
- No. 1654 Constant Air Reserve Valve
- Complete Instructions

Retail \$127.25

## NO. 1485 SCUBAIR UNDERWATER BREATHING APPARATUS

Includes:

- No. 1665 Scubair Regulator
- No. 1607-71.2 Cu. Ft. Tank Assembly, galvanized
- No. 1652 High Pressure Valve
- Complete Instructions

Retail \$107.25

## NO. 1487 SCUBAIR SELF-CONTAINED UNDERWATER BREATHING APPARATUS

Includes:

- No. 1665 Scubair Regulator
- No. 1648-71.2 Cu. Ft. Double Tank Tank Assembly, galvanized
- No. 1653 Constant Air Reserve Valve for Double Tank Assembly - Complete Instructions

Retail \$197.50

## NO. 1496 SCUBA DELUXE SELF-CONTAINED BREATHING APPARATUS

Includes:

- No. 1611 Scuba Deluxe Regulator
- No. 1640-42 Cu. Ft. Double Tank Assembly, galvanized
- No. 1653 Constant Air Reserve Valve for Double Tank Assembly
- Complete Instructions

Retail \$192.50

## NO. 1634 SCUBA DELUXE SELF-CONTAINED UNDERWATER BREATHING APPARATUS

Includes:

- No. 1611 Scuba Deluxe Regulator
- No. 1627-71.2 Cu. Ft. Tank Assembly, galvanized
- No. 1654 Constant Air Reserve Valve
- Complete Instructions

Retail \$137.25

## NO. 1612 SCUBA DELUXE SELF-CONTAINED UNDERWATER BREATHING APPARATUS

Includes:

- No. 1611 Scuba Deluxe Regulator
- No. 1607-71.2 Cu. Ft. Tank Assembly, galvanized
- No. 1652 High Pressure Valve
- Complete Instructions

Retail \$117.25

## NO. 1497 SCUBA DELUXE SELF-CONTAINED UNDERWATER BREATHING APPARATUS

Includes:

- No. 1611 Scuba Deluxe Regulator
- No. 1648-71.2 Cu. Ft. Double Tank Assembly, galvanized
- No. 1653 Constant Air Reserve Valve for Double Tank Assembly
- Complete Instructions

Retail \$207.50

# SCUBAPAK HARNESS

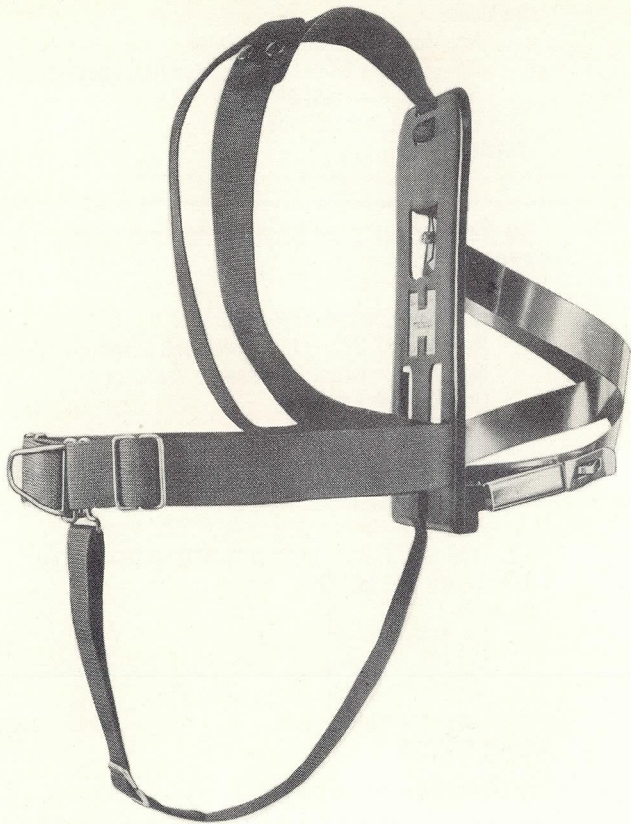

**Cat. No. 1444**  
**SCUBAPAK SINGLE**  
**TANK HARNESS**  
Retail \$14.95  
(Pat. Pend.)

Completely new design by Richard E. Anderson that combines safety, comfort and utility. The SCUBAPAK is made of a single sheet of specially-compounded aluminum. A protective smooth surface coating of resilient high impact vinyl makes the backplate impervious to salt water and the elements. The arrangement of the back plate puts the tank where it should be on the divers back. The ends of the nylon harness are dipped in Healthways special rubber compound to prevent fraying. The single tank harness features Healthways revolutionary new Stainless Steel "criss-cross" band design. This design provides

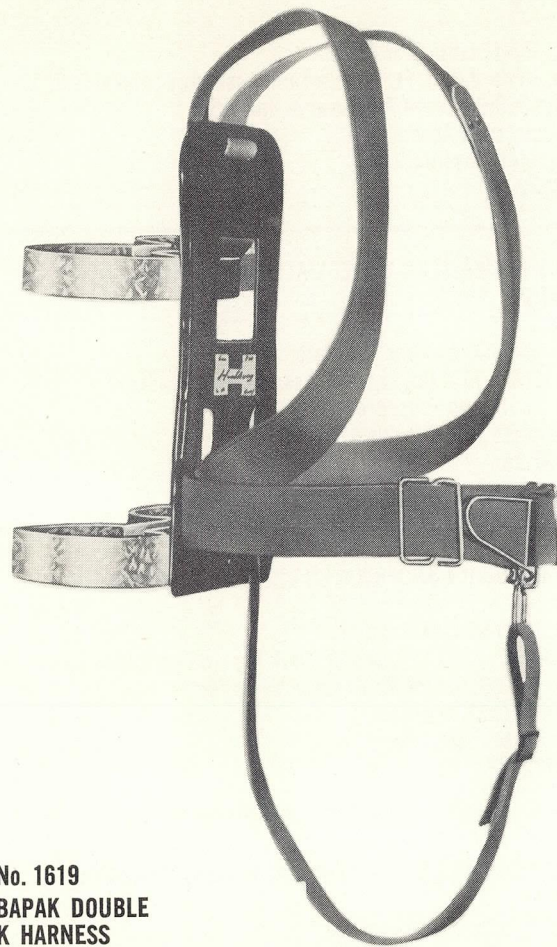

**Cat No. 1619**  
**SCUBAPAK DOUBLE**  
**TANK HARNESS**  
Retail \$16.50

a more secure tank attachment than the conventional two parallel or single center band arrangement. The adjustable "criss-cross" design incorporates an instant action quick release latch, allows removal of the SCUBAPAK in seconds. Equipped with Healthways Jet-O-Sen quick release buckle, a crotch strap that may be used at the option of the diver, plus the quick button safety release on the shoulder strap. Two easy-to-carry handles, designed as an integral part of the harness, make carrying your SCUBA as easy as carrying a suitcase.

**Cat. No. 1942-03**  
**SCUBAPAK 2" SAFETY**  
**BUCKLE ASSEMBLY**  
Stainless Steel—4 pcs.  
(Fits 2" to 2½" Web  
Belts and Scuba harness)  
Retail \$1.75

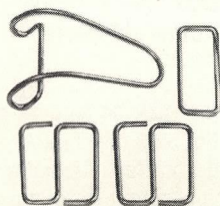

**Cat No. 1619-11**  
**DOUBLE TANK BANDS**  
Retail \$3.15

Used to convert Healthways single tank assemblies to double tank assemblies

# SCUBAPAK CONTOUR HARNESS



**Cat. No. 1445**  
**CONTOUR SCUBAPAK SINGLE**  
**TANK HARNESS**  
 Retail \$16.95

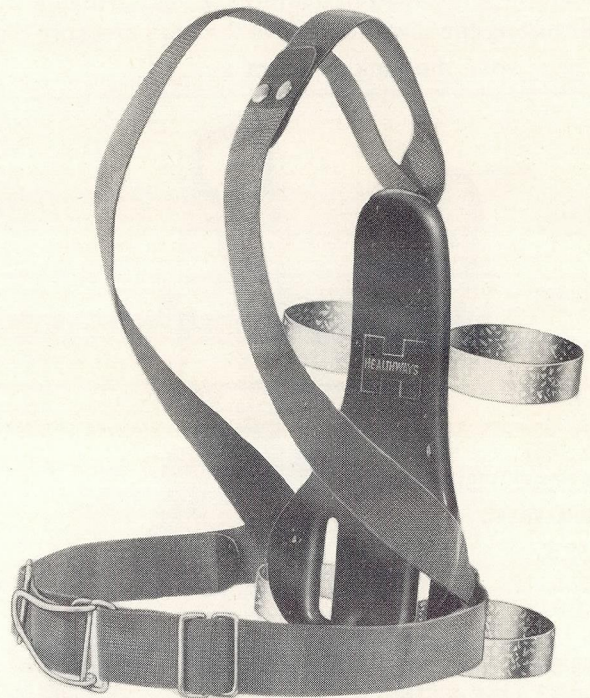

**Cat. No. 1446**  
**CONTOUR SCUBAPAK DOUBLE**  
**TANK HARNESS**  
 Retail \$18.50

Healthways new Deluxe CONTOUR SCUBAPAK, incorporates all the outstanding features of the famous standard SCUBAPAK, nylon webbing, easy-to-carry handles, continuous strap arrangement and the Jet-O-Sen quick release safety buckle. These features are incorporated without adding unnecessary bulk to achieve what a contour pak is designed to do. The CONTOUR SCUBAPAK is designed to eliminate large gaps in the back plate and as a result is truly the most comfortable and form fitting

contour pak ever developed. The single tank harness features Healthways revolutionary new Stainless Steel "criss-cross" band design. This design provides a more secure tank attachment than the conventional two parallel or single center band arrangement. The adjustable "criss-cross" design incorporates an instant action quick release latch which allows removal of the CONTOUR SCUBAPAK in seconds.

## TWO INTEGRATED DESIGNS

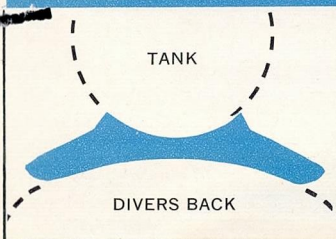

## SCULPTURED TO FIT SMALL OF THE BACK

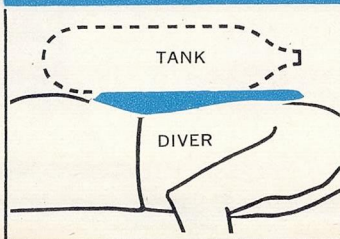

## EASY-TO-CARRY HANDLES

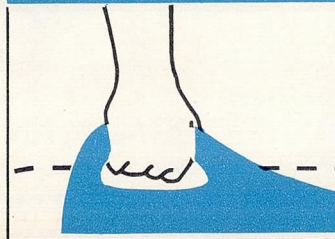

## CRISS-CROSS BANDS & QUICK RELEASE LATCH



# PROFESSIONAL TANK VALVES

Healthways Professional Valves are specifically designed for SCUBA diving — The safest and most thoroughly engineered valves available — designed by professionals to meet the strict requirements of the discriminating diver. All Healthways Professional Valves contain an absolute fool proof safety plug. Healthways exclusively features a high-pressure outlet that is connected downstream of the shutoff — permitting the diver to remove the high pressure plug and install a Submersible Scub-Air Tank Pressure Gauge while the tank is full of air.

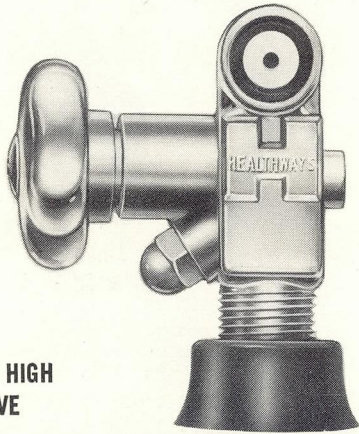

**Cat. No. 1652**  
**PROFESSIONAL HIGH**  
**PRESSURE VALVE**  
 Retail \$9.95

See page 41 for replacement parts

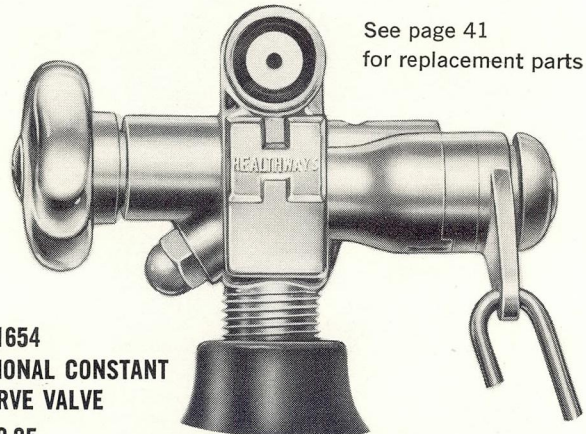

See page 41  
 for replacement parts

**Cat. No. 1654**  
**PROFESSIONAL CONSTANT**  
**AIR RESERVE VALVE**  
 Retail \$29.95

Cat. No. 1643 Pull Rod included

**Cat. No. 1653**  
**PROFESSIONAL CONSTANT AIR RESERVE VALVE**  
**FOR DOUBLE TANK ASSEMBLY**  
 Retail \$49.95

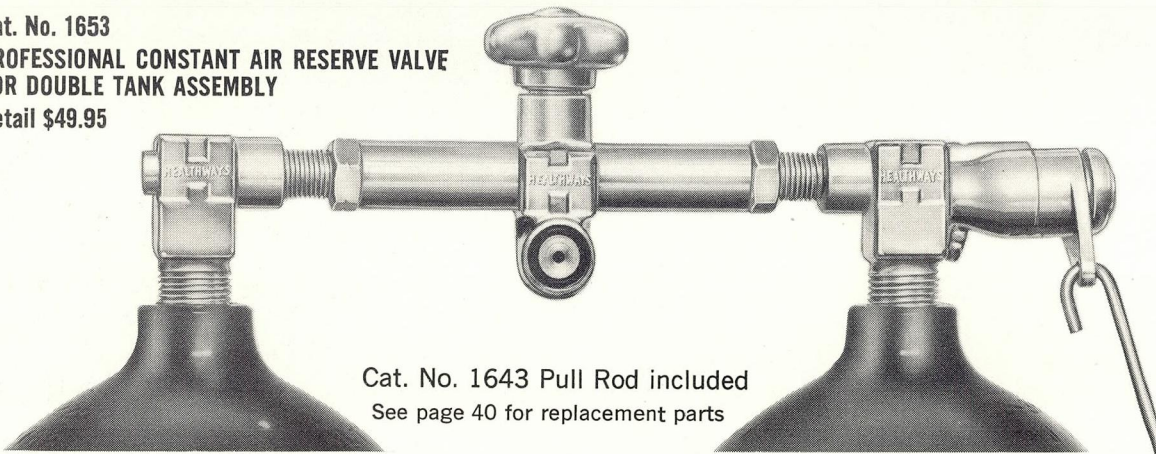

Cat. No. 1643 Pull Rod included  
 See page 40 for replacement parts

**Cat. No. 1609**  
**PROFESSIONAL HIGH PRESSURE VALVE**  
**FOR DOUBLE TANK ASSEMBLY**  
 Retail \$27.95

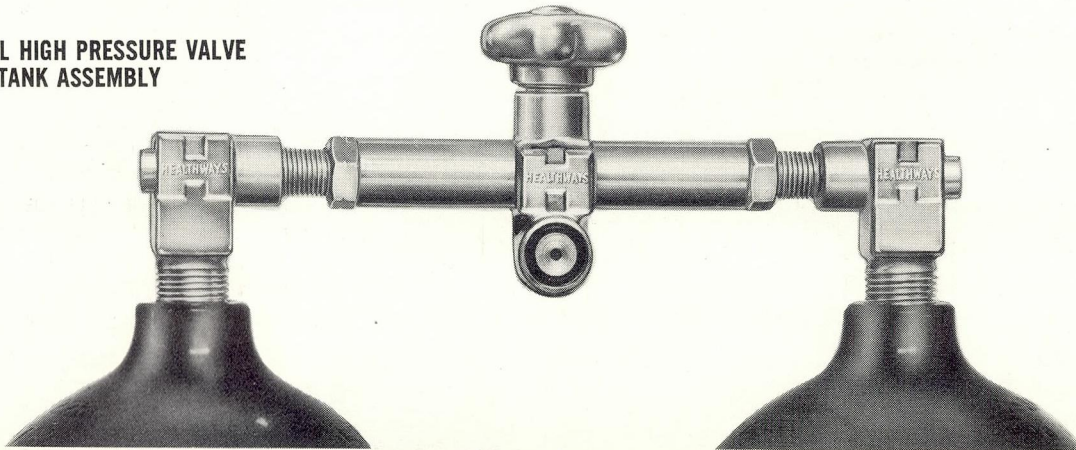

See page 40 for replacement parts



# SCUBA ACCESSORIES

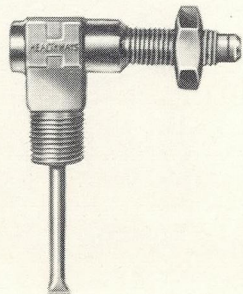

**Cat. No. 1653-02**  
**ELBOW FOR DOUBLE**  
**TANK MANIFOLD**  
 Left hand thread  
 Retail \$5.95

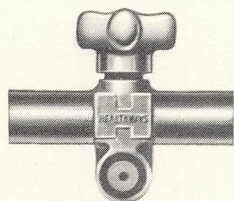

**Cat. No. 1653-01**  
**CONTROL VALVE**  
 Retail \$16.00

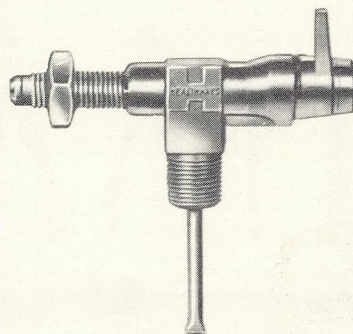

**Cat. No. 1653-03**  
**CONSTANT RESERVE VALVE**  
**FOR DOUBLE TANK MANIFOLD**  
 Retail \$28.50

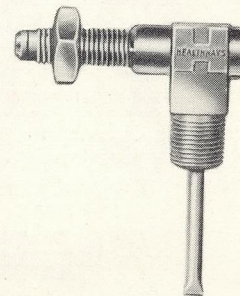

**Cat. No. 1609-03**  
**ELBOW FOR DOUBLE**  
**TANK MANIFOLD**  
 Right hand thread  
 Retail \$5.95

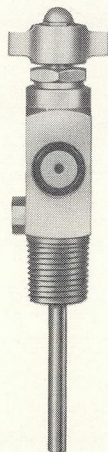

**Cat. No. 1603**  
**HIGH PRESSURE VALVE**  
 Retail \$6.95

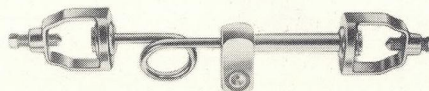

**Cat. No. 1606**  
**TWO TANK YOKE ASSEMBLY**  
 (Standard pigtail type)  
 Retail \$14.95

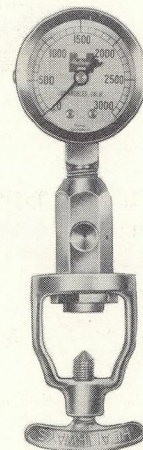

**Cat. No. 1614**  
**PRESSURE GAUGE**  
**AND YOKE**  
**WITH BLEEDER VALVE**  
 Retail \$9.95

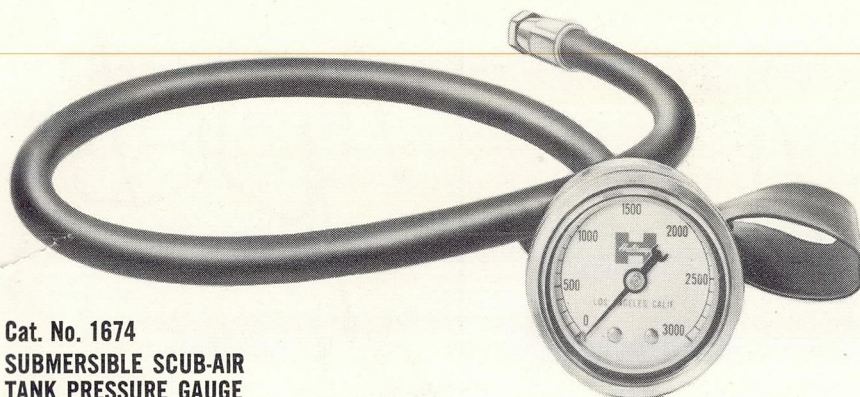

**Cat. No. 1674**  
**SUBMERSIBLE SCUB-AIR**  
**TANK PRESSURE GAUGE**  
 (For accurate reading of cylinder  
 pressure while diving)  
 Retail \$19.95

The completely new Submersible Scub-Air Tank Pressure Gauge with a large easy to read dial, features a water and pressure proof chrome plated brass case. The flexible high pressure hose features a Stainless Steel wire braid with a BUNA liner and a neoprene outer covering.

See page 40 for replacement parts

# SCUBA ACCESSORIES

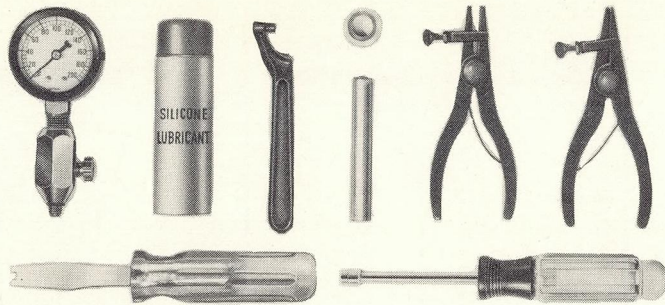

**Cat. No. 1447**  
**REGULATOR AND VALVE REPAIR KIT**

Includes: regulator and valve exploded views, regulator instruction books, 200 lb. test gauge, all necessary "special" tools and a list of suggested spare parts.



**Cat. No. 1696**  
**TANK VALVE SEALING COMPOUND**  
(for securely inserting valves in tanks)  
**Retail \$2.75**



**Cat. No. 1639**  
**SCUBA DELUXE HOSE ASSEMBLY**

Includes:  
Cat. No. 1601-01 Air Flo Hose for Scuba (two)  
Cat. No. 1621 Scuba Non-return valve  
Cat. No. 1611-47 Hose clamps (two)  
**Retail \$8.95**

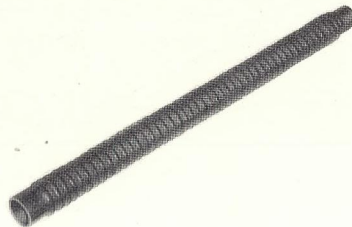

**Cat. No. 1601-01**  
**AIR-FLO HOSE FOR SCUBA**  
(sold separately without clamps)  
Special neoprene and pure gum rubber-patented spiral principal.  
**Retail \$2.50**

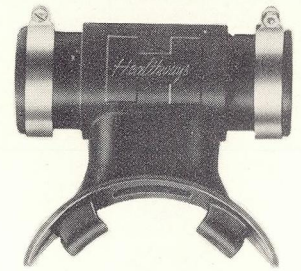

**Cat. No. 1621**  
**SCUBA NON-RETURN VALVE**  
Includes:  
Cat. No. 1621-01 Mouthpiece  
Cat. No. 1621-02 Nylon inserts (two)  
Cat. No. 1621-03 Non-return rubber valves (two)  
Cat. No. 1621-04 Hose clamps (two)  
Cat. No. 1621-05 Baffle **Retail \$4.95**



**Cat. No. 1448**  
**TANK BOOT**

A "slip-on" tank stand. Used to protect boat decks and swimming pools. Made of durable Zetathin.  
**Retail \$4.95**

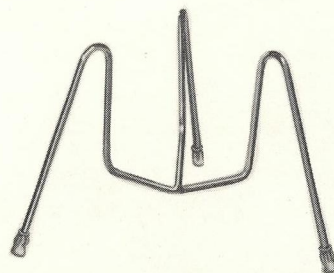

**Cat. No. 1690**  
**SINGLE TANK DISPLAY STAND**  
**Retail \$4.95**

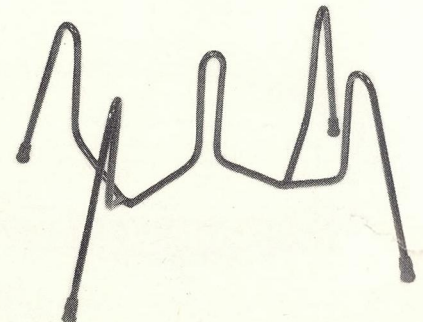

**Cat. No. 1691**  
**DOUBLE TANK DISPLAY STAND**  
**Retail \$7.95**

# SCUBAIR HOOK-UP

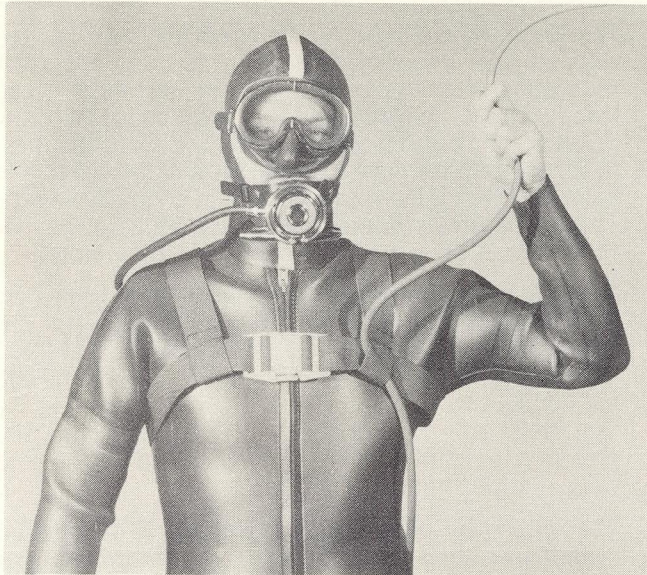

## FRONT VIEW

Featured with 2" nylon webbing which is laced in a manner that gives you complete freedom of movement, comfort and adjustability. The ends of the webbing are dipped in Healthways exclusive rubber compound to prevent fraying.

The harness is equipped with a newly designed nylon safety buckle.

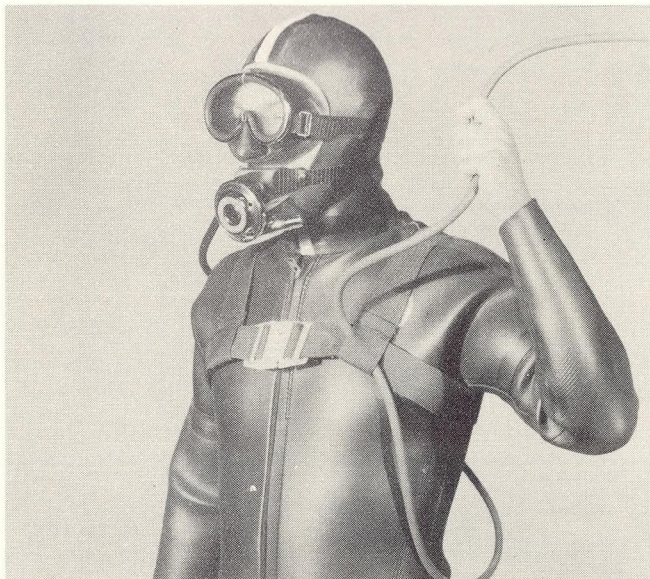

## SIDE VIEW

The surface air hose is brought under the left arm and through the front left webbing loop. This is to prevent a direct right angle pull against the check valve hose fitting, and also to keep the surface hose within reach of the diver for signalling. The Scubair "Hook-up" is completely independent of the weight belt.

Cat. No. 1689

## SCUBAIR SURFACE AIR SUPPLY HOOK-UP

Includes Second Stage of Scubair Regulator, Harness, and Back Plate with Check Valve.

Retail \$48.00

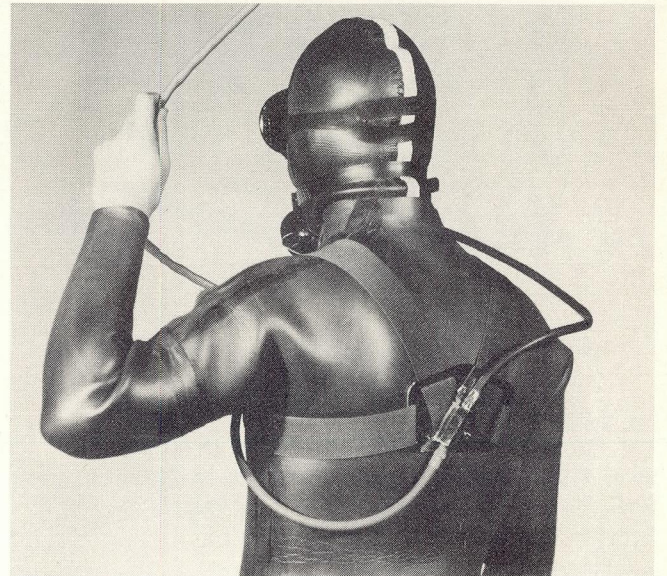

## BACK VIEW

The back plate is made from chrome plated, 1/16" sheet brass. The positive action check valve is silver braised directly on to the back plate before final plating. This insures that the check valve absolutely can not be torn loose from the back plate. This is important, because in most instances, the diver's air hose also serves as his life line. The check valve plays an important part, preventing the air in the diver's respiratory system from being forced back up the hose, should a rupture in the air hose occur at the surface. The check valve has a plug which can be easily removed for inspection and maintenance. Under the plug is a stainless steel spring and check ball. The inlet of the check valve has a standard 1/4" pipe thread which the diver can adapt to any hose connection he may desire to use.

Cat. No.	DESCRIPTION	Retail
1688	Surface Air "Hook-up" Harness.....	25.50
1688-02	Check Valve Complete .....	9.95
1688-08	2" Blue Nylon Webbing, 4 1/2' each (2 req.).....	3.00
1688-09	Black Nylon Buckle (male).....	.50
1688-10	Black Nylon Buckle (female).....	.50
1688-65	Back Plate Assembly with Check Valve.....	25.00
1665-66	Scubair Hook-up Regulator .....	\$22.50

# SCUBA ACCESSORIES

## SCUBA AIR COMPRESSOR

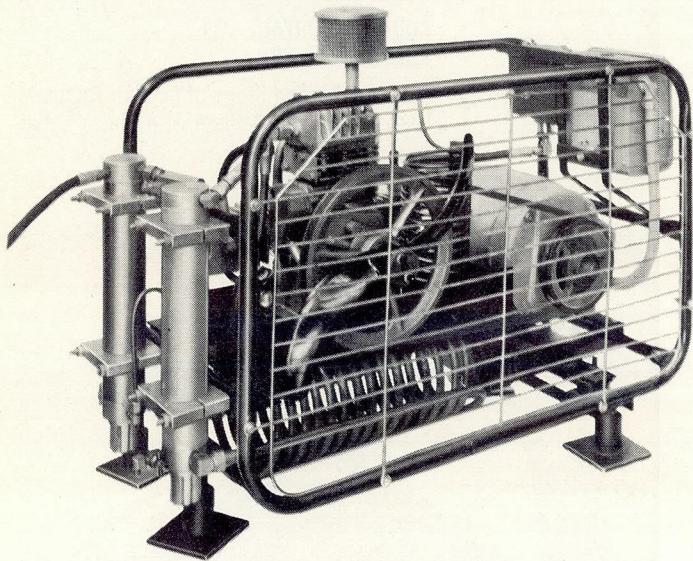

**Cat. No. 1997**  
7 HP Kohler Engine

**Cat. No. 1998**  
3 HP Electric  
Motor; 110 or 220 volts,  
Single Phase

**Cat. No. 1999**  
3 HP Electric  
Motor; 220 or 440 volts,  
3 Phase

The Healthways Scuba Air Compressor has been developed after years of research and study and after thousands of hours of testing. The technical excellence, output and durability of the Scuba Air Compressor is incomparable. This unit will meet the most stringent requirements. It will fill a tank faster and safer than any other unit available of comparable size. The Scuba Air Compressor will fill a 71.2 cu. ft. tank from 0 to 2250 psi in approximately 13 minutes.

The Scuba Air Compressor is equipped with two safety devices on the high pressure system that are pre-set. One is the pressure-actuated cut off switch set at 2300 psi and the other is a pressure relief valve set at 2500 psi. It has two specially-designed filters: one for the first stage and another for the third stage. The compressor is mounted on a spring-loaded frame and weighs approximately 188 lbs.

The Scuba Air Compressor is a 3-stage, 2000 rpm air compressor, driven by any of the three following power plants:

1. 7 HP Kohler reciprocating engine.
2. 3 HP General Electric Motor, 110 or 220 volts, single phase.
3. 3 HP General Electric Motor, 220 or 440 volts, 3-phase.

### No. 1693

FILLER AND GAUGE COMBINATION WITH BLEEDER VALVE

(For simultaneous tank refilling and pressure reading.)

Retail \$17.95

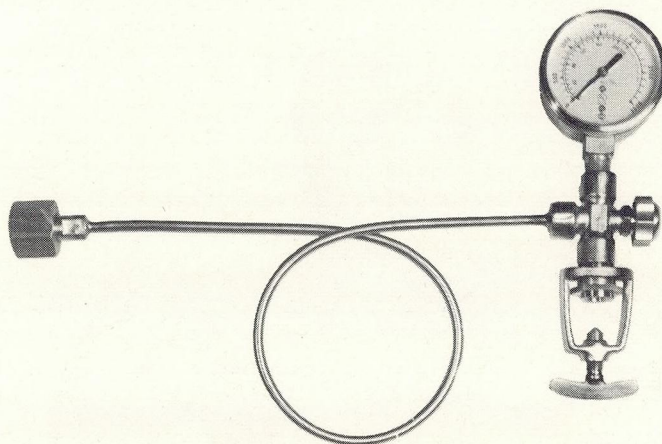

## The DOUBLETTE

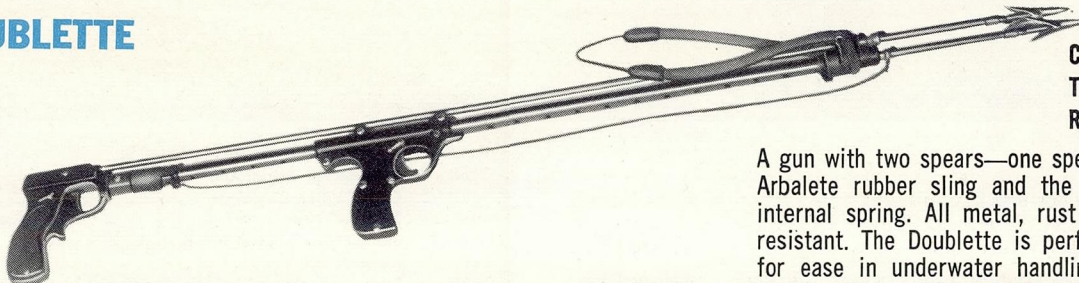

**Cat. No. 1520**  
**THE DOUBLETTE**  
Retail \$39.95

A gun with two spears—one spear powered by Arbalete rubber sling and the second by an internal spring. All metal, rust and corrosion resistant. The Doublette is perfectly balanced for ease in underwater handling. Pistol grip handle with positive safety catch for arbalete spear release. Center pistol grip with positive safety catch for spring powered spear release.

See page 44 for replacement parts

# SPEARFISHING GUNS

Cat. No. 1502

**SHARK SLING SPEAR GUN**

Retail \$4.95

Modeled after the original Hawaiian design, used for centuries in the South Pacific. Fast, accurate and powerful. High impact styrene handle and 4 ft. plated spear. Non-slip, hand-fitting grip. This gun is ideal for close up work.

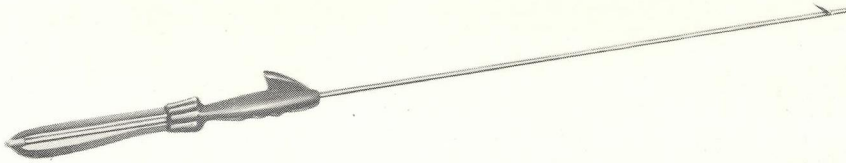

See page 43 for replacement parts

## ESPADON ARBALETES

Developed by G. Beauchat, the originator of the arbaete, Espadon Arbaletes are dependable all-around spear fishing guns. Scientifically balanced and designed to float after release of the spear. The Espadon features improved hand-wrapped rubber power slings, tough plastic high impact handles with a positive safety lever and corrosion and rust resistant "Ocean Blue" finish.

Cat. No. 1507

**BANTAM ESPADON**

Retail \$11.95



See page 43 for replacement parts

Cat. No. 1508

**JUNIOR ESPADON**

Retail \$14.50

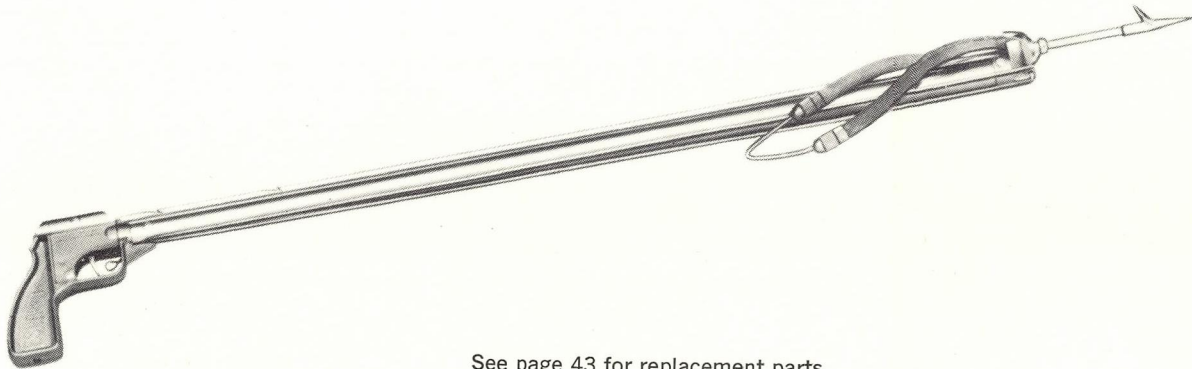

See page 43 for replacement parts

Cat. No. 1509

**STANDARD ESPADON**

Retail \$16.95

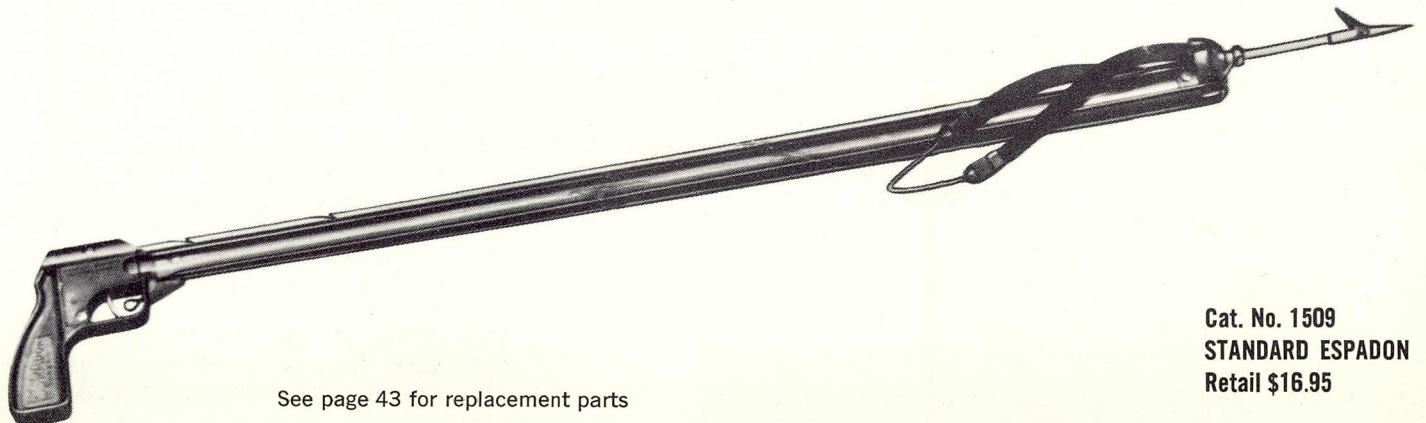

See page 43 for replacement parts

# SPEARFISHING GUNS

## PECHE SPORT ARBALETTES

The original all-metal, rust and corrosion resistant gun, Peche-Sport Arbaletes are perfectly balanced to be weightless under water. Featuring a comfortable pistol-grip handle and a positive safety catch, Peche-Sport Arbaletes will float to the surface after the spear has been released.

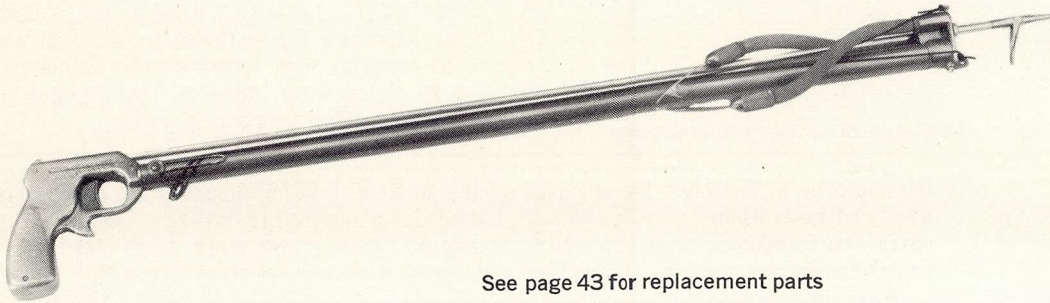

See page 43 for replacement parts

Cat. No. 1504  
PECHE-SPORT JUNIOR  
Retail \$17.50

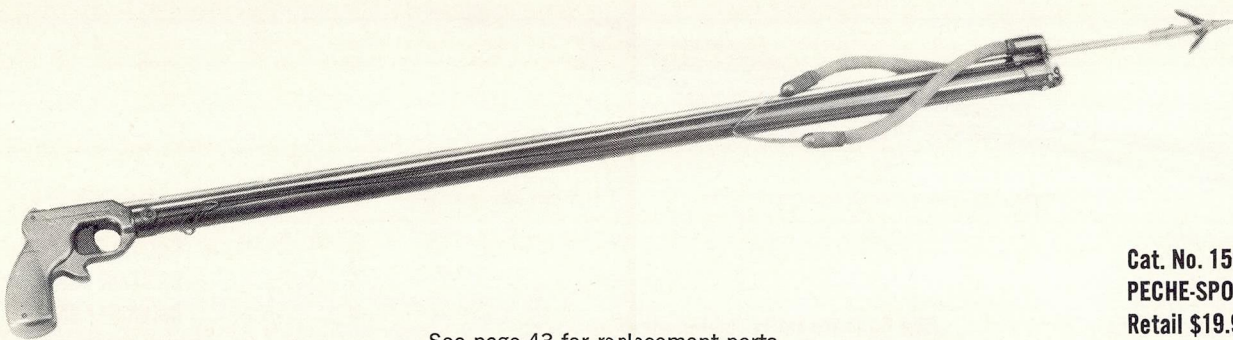

See page 43 for replacement parts

Cat. No. 1505  
PECHE-SPORT STANDARD  
Retail \$19.95

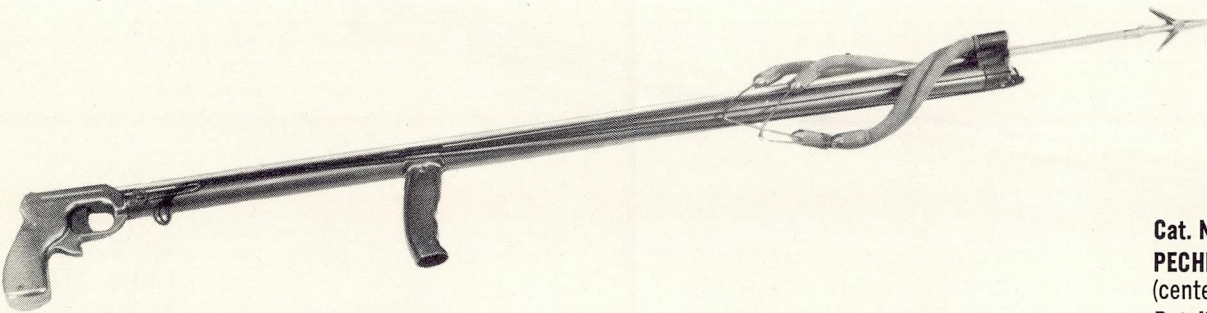

See page 43 for replacement parts

Cat. No. 1506  
PECHE-SPORT DELUXE  
(center grip)  
Retail \$27.50

## The SAETTA



See page 44 for replacement parts

Cat. No. 1531  
SAETTA  
Retail \$24.95

Imported from Italy, Cressi guns are recognized as the finest in quality, accuracy and power. The Saetta is complete with spear, spearhead, nylon line and charger. The center pistol grip provides perfect balance for accuracy.

Unusually accurate, highly maneuverable and easily charged, The Saetta is internally spring powered. Non-corrosive construction throughout.

# SPEARHEADS AND ACCESSORIES



**Cat. No. 1513-10**  
**ARBALETE SPEARHEAD ADAPTER**  
 (permits use of all Arbalete-type spearheads)  
 Retail \$ .75



**Cat. No. 1504-02**  
**SINGLE BARB**  
 Retail \$ .98



**Cat. No. 1505-02**  
**DOUBLE BARB**  
 Retail \$1.98

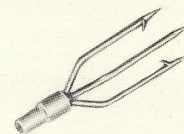

**Cat. No. 1507-02**  
**TRI-POINT**  
 Retail \$1.75

## CRESSI SPEARHEADS

Famous the world over for their fine quality, these spearheads are interchangeable for all Cressi spears and with the use of Cat. No. 1500-10 adapter, may be used on French Arbalete spearshafts.

**Cat. No. 1500-10**  
**ADAPTER SLEEVE**  
**SPEARHEAD**

(Permits Cressi spearheads to be used on any Peche-Sport or other French Arbalete spearshafts). Retail \$ .75

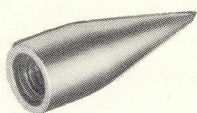

**Cat. No. 1530-01**  
**SPEARHEAD TIP**  
 (Fits all Cressi spearheads)  
 Retail \$ .40

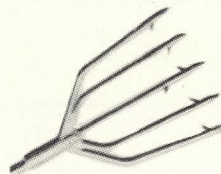

**Cat. No. 1511-02**  
**FIVE PRONG**  
 Retail \$1.75



**Cat. No. 1533-02**  
**TWO BARB**  
 Retail \$1.95

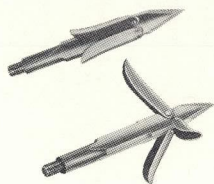

**Cat. No. 1500-06**  
**THREE BARB STAR**  
 Retail \$4.50

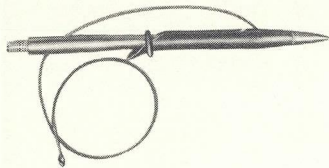

**Cat. No. 1512-02**  
**DETACHABLE HEAD**  
 Retail \$3.75



**Cat. No. 1591**  
**NYLON LINE**  
 (200 lb. test, 150 ft. spool)  
 Retail \$5.25

## SWIMMING AIDS



**Cat. No. 1928**  
**EAR STOPPLES**  
 (Assorted sizes)  
 Retail \$ .25 pr.

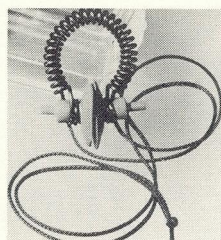

**Cat. No. 1930**  
**CRESSI PROFESSIONAL NOSE CLIPS**  
 (Pure gum rubber-standard size)  
 Retail \$ .75

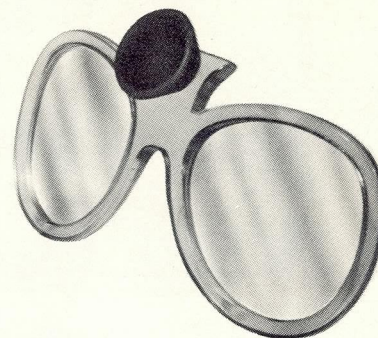

**Cat. No. 1962**  
**PRESCRIPTION LENS HOLDER**  
 Fits all popular standard masks. Through a suction cup, lens holder can be adjusted for every mask and for every vision requirement.  
 Retail \$3.95



**Cat. No. 1915**  
**NOSE CLIPS**  
 Pure Latex  
 (Standard size)  
 Retail \$ .50

# DIVING ACCESSORIES

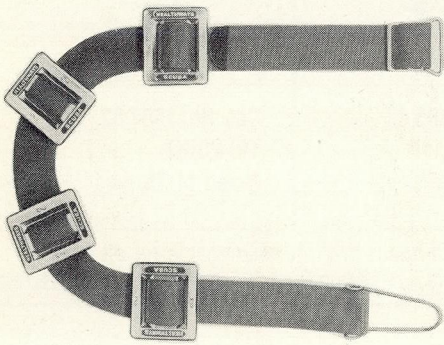

**Cat. No. 1942**  
**PROFESSIONAL LEAD WEIGHT BELT — 8 LBS.**

Includes:  
Cat. No. 1943-01 — 2 lb. "Sandwich" lead weights (four)  
Cat. No. 1942-02 2" Professional web belt with a new Jet-O-Sen quick release safety buckle assembly that allows easy adjustment with a simple pull.  
**Retail \$10.95**

**Cat. No. 1942-02**  
**PROFESSIONAL WEIGHT BELT**  
(2" web belt with Jet-O-Sen safety buckle assembly)  
**Retail \$2.95**

**Cat. No. 1943-01**  
**2-LB. "SANDWICH" LEAD WEIGHT**  
(Fits 2" web belt)  
**Retail \$2.00**

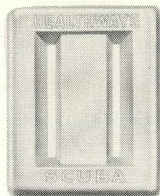

**No. 1944-01**  
**3-LB. "SANDWICH" LEAD WEIGHT**  
(Fits 2" web belt)  
**Retail \$3.00**

**Cat. No. 1942-04**  
**JET-O-SEN 2" SAFETY BUCKLE ASSEMBLY**

Stainless Steel — 2 pcs. (fits 2" to 2 1/8" web belts and SCUBA harness)  
**Retail \$1.75**

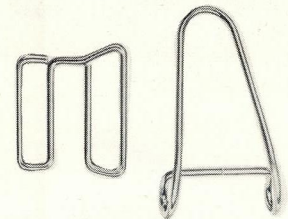

## The NAVIGATOR

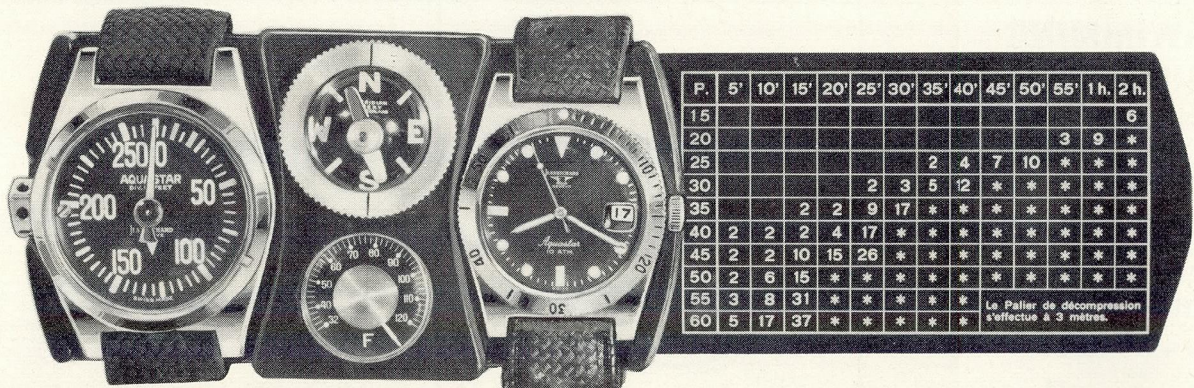

This unique innovation concentrates all the diver's necessary instruments in one handy bracelet-like panel, plus providing a decompression table.

The panel consists of:

- Aquastar Deluxe Watch
- Aquastar Special 250 ft. Depth Gauge
- Compass
- Water Thermometer
- Decompression Table

**Cat. No. 1979**  
**NAVIGATOR**  
**Retail \$150.00**



# DIVING ACCESSORIES

**Cat. No. 1985**  
**ESPADON DELUXE**  
**KNIFE AND SHEATH**  
Retail \$9.95

**Cat. No. 1983**  
**ESPADON DELUXE KNIFE ONLY**  
Retail \$6.50

**Cat. No. 1984**  
**ESPADON DELUXE SHEATH ONLY**  
Retail \$3.50

An extra heavy duty, exceptionally strong stainless steel knife with a Plastisol coated aluminum handle. Exclusive design of the sheath permits attaching to calf of the leg — the proper positioning for skin diving knives.

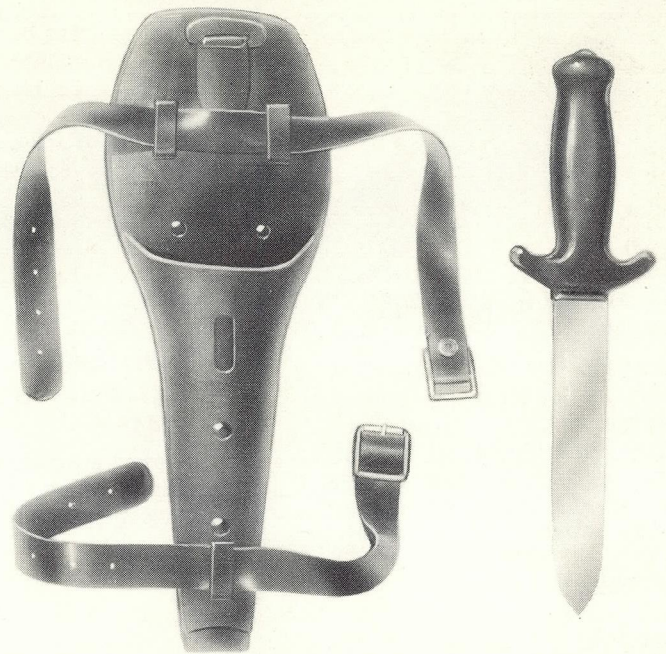

**Cat. No. 1955**  
**ESPADON KNIFE AND SHEATH**  
Retail \$8.95

**Cat. No. 1953**  
**ESPADON KNIFE ONLY**  
Retail \$5.95

**Cat. No. 1954**  
**ESPADON SHEATH ONLY**  
Retail \$3.00



**Cat. No. 1990**  
**"BIG JIM" Divers Knife**  
Retail \$4.95

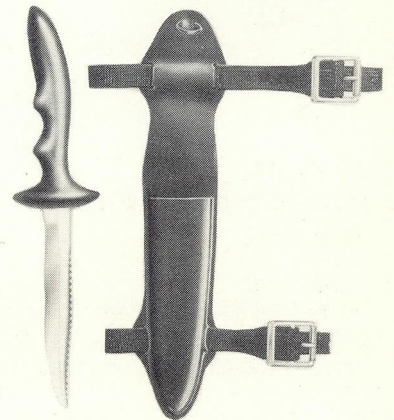

**Cat. No. 1991**  
**SCUBA-LITE**  
Retail \$12.95

The Scubalite, with 80,000 candle power, is the most powerful diving lite ever developed for Scuba divers. The pressure resistant one piece body, made of high-impact Marlex, features a completely water, pressure and corrosion-proof switch and an easy to grip handle.

A simple quarter turn gives the lens a positive seal, just as in the deep sea divers helmet.

(Uses 6 standard size "D" batteries that are available everywhere.)



# DIVING ACCESSORIES

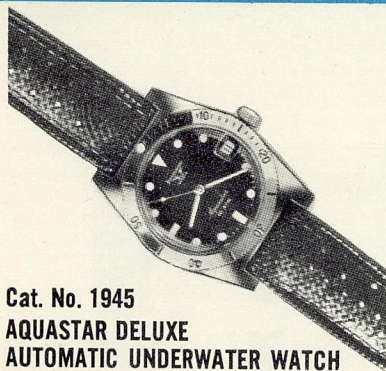

**Cat. No. 1945**  
**AQUASTAR DELUXE**  
**AUTOMATIC UNDERWATER WATCH**  
 Retail \$79.95

A completely new watch designed especially for the diver with all these important features: Automatic self-winding, bezel moving dial to record diving time, calendar window, luminous markings, antimagnetic and the finest 17-jewel movement. One year guarantee. Imported from JeanRichard, Geneva, Switzerland.



**Cat. No. 1946**  
**AQUASTAR UNDERWATER WATCH**  
 Retail \$34.50

A diver's watch from the world famous JeanRichard of Switzerland. 7-jewel stem-wound movement, luminous markings, antimagnetic. One year guarantee.



**Cat. No. 1947**  
**AQUASTARLET UNDERWATER WATCH**  
 Retail \$49.95

The finest compact size watch with all these outstanding features: Calendar window, bezel moving dial to record diving time, luminous markings, antimagnetic and a superb 17-jewel movement. One year guarantee. Imported from JeanRichard, Switzerland.



**Cat. No. 1956**  
**200 FT. DIVERS DEPTH GAUGE**  
 Retail \$8.95

Corrosion proof chrome plated brass housing, rubber encased with form-fitting wrist strap.



**Cat. No. 1958**  
**250 FT. DIVERS COMBINATION**  
**COMPASS AND DEPTH GAUGE**  
 Retail \$10.95

Corrosion proof chrome plated brass housing, rubber encased with form-fitting wrist strap.



**Cat. No. 1964**  
**SUBMARINE LIQUID COMPASS**  
 Retail \$5.95



**Cat. No. 1957**  
**250 FT. AQUASTAR PROFESSIONAL**  
**DEPTH GAUGE**  
 Retail \$12.95

A precise divers gauge—heavy chrome plated brass. Curved wrist-fitting housing. Saltwater impervious strap.



**Cat. No. 1959**  
**250 FT. AQUASTAR PROFESSIONAL**  
**COMPASS AND DEPTH GAUGE**  
**COMBINATION**  
 Retail \$14.95

A precise compass and depth gauge combination—heavy chrome plated brass. Curved wrist-fitting housing. Saltwater impervious strap.



**Cat. No. 1986**  
**UNDERWATER THERMOMETER**  
 Retail \$3.95

# DIVING SAFETY SECTION

**Cat. No. 1988**  
**SCUBA-VEST LIFE JACKET**  
 Retail \$9.95

Designed by Jim Christiansen, one of America's foremost advocates of diving safety. Made of specially prepared material, the inside of which is completely saturated with a specially compounded leak-proof and corrosion proof heavy coating.

The Scuba-Vest is engineered to float an unconscious or resting diver in a "face up" position. Experience has shown that although the Scuba-Vest is primarily a safety device it can be utilized for that "long swim back to the boat."

The Scuba-Vest is reversible. One side is professional black. The other side is officially approved International Orange, the most vivid of colors for diving safety. In an emergency, a diver wearing the black side out can easily reverse the Scuba-Vest to show the orange side for easy identification.



The Scuba-Vest is inflated by means of a "squeeze-grip" detonator containing an over-size, cadmium plated CO<sub>2</sub> cartridge. The re-usable detonator can be easily removed and a new CO<sub>2</sub> cartridge installed, ready for instant re-use.

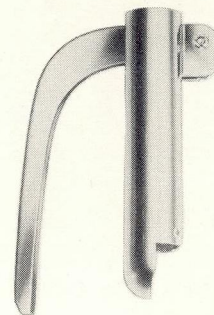

**Cat. No. 1988-02**  
**DETONATOR**  
 Retail \$3.00

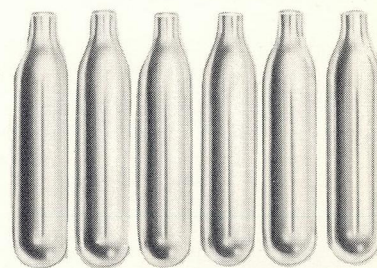

**Cat. No. 1989**  
**CO<sub>2</sub> CARTRIDGES**  
 (pkg. of 6)  
 Retail \$3.00

DEPTH IN FEET	TIME OF DIVE IN MINUTES		DECOMPRESSION TIME	
	NOT REQUIRED	REQUIRED	AT 10 FEET	
50	78 →	120	—	2
60	55	75	—	2
70	43	60	—	4
80	35	50	—	6
90	30	45	—	6
100	25	40	—	12
120	18	30	—	11
140	12	15	—	4
160	8	15	—	9
180	5	10	—	7
200	4 →	8	—	25

IF THIS TIME IS EXCEEDED  
 USE NEXT COLUMN

FOR DEPTH AND TIME EXCEEDING THIS TABLE USE  
**HEALTHWAY'S DECOMPRESSION METER**

**Cat No. 1719**  
**DECOMPRESSION TABLE DECAL**  
 Retail \$1.50

Healthways Decompression Table Decal gives you the maximum diving time at a given depth with no decompression and maximum diving time with decompression only at 10 feet. Healthways Decompression Table is easily attached to the arm of the Coronado Deluxe Neoprene Suit.

Pat. Pending

# DIVING SAFETY SECTION

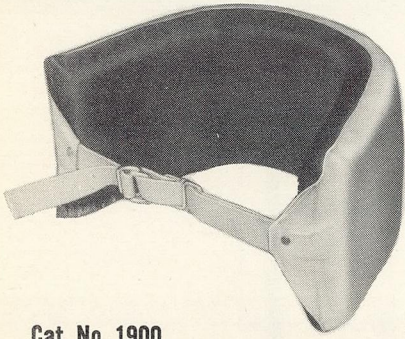

**Cat. No. 1900**  
**"AQUA-FLITE" FOAM SAFETY BELT**  
 Retail \$5.95

For the water skier and sportsman. For the first time — a truly comfortable safety belt. Made of unsinkable, specially compounded rubber, a material that withstands the elements. Electronically sealed with special process, vinyl laminated, heavy duty cotton twill. 1" web belt is imbedded in foam.

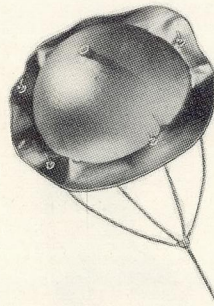

**Cat. No. 1987**  
**MARKER BOUY**  
 Retail \$1.95

A unique, inflatable marker float. Can be used as a safety float in the pool or a marker for the boating enthusiast or skin diver.

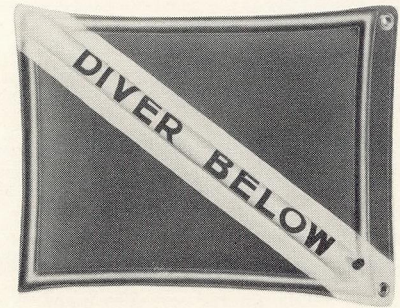

**Cat. No. 1969**  
**INFLATABLE DIVERS FLAG**  
 Retail \$1.95

The most sensational divers safety flag ever devised. Heavy duty vinyl. Inflatable rim . . . it remains unfurled at all times.

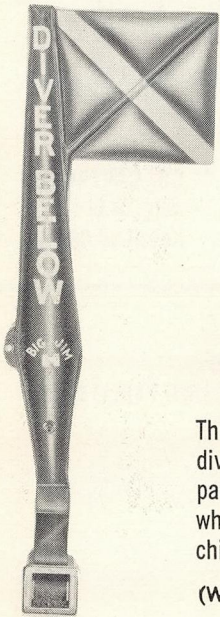

**Cat. No. 1981**  
**"BIG-JIM" DIVERS FLAG BUOY**  
 Retail \$3.50

The "Big Jim" Divers Flag/Buoy combines the conventional divers flag and a new inflatable marker buoy into one compact and functional unit. The "Big Jim" Divers Flag/Buoy, when deflated, can be folded into the size of a handkerchief and carried in a pocket or similar small place.

(Weight is not included)

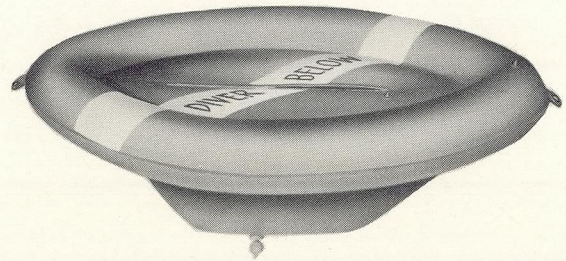

**Cat. No. 1992**  
**DIVERS UTILITY BAG/SAFETY FLOAT**  
 Retail \$6.95

The most practical safety float ever designed. Zipper pocket—inflatable rim. Made of heavy duty vinyl, 48" x 30"

**Cat. No. 1912**  
**"UNDERWATER SAFETY"**  
 by E. R. CROSS  
 Retail \$1.00



**Cat. No. 1993**  
**UNDERWATER SOCIETY OF AMERICA**  
**DECALS (CARD OF 24)**  
 Retail \$ .50 per decal

# SUBMARINES AND BOATS

## SUBMARINES



**Cat. No. 1995**  
**STANDARD SUBMARINE—SEA SHARK**  
Retail \$1,500.00

The ultimate in underwater transportation for the SCUBA diver. Developed after many years of research with a prototype, which made an underwater crossing from Los Angeles to Santa Catalina Island in six and one-half hours. The SEA SHARK and the NAUTILUS operate below the surface at a speed of 4 mph or on the surface at 6 mph. Constructed of high-impact fiberglass, 15 feet long with a 32 inch beam and weighing approximately 500 pounds. Propelled by an electric motor powered by specially constructed batteries, both submarines utilize an air-

**Cat. No. 1996**  
**DELUXE SUBMARINE—NAUTILUS**  
Retail \$2,500.00

craft-type control stick. SEA SHARK Cat. No. 1995... Retail \$1,500.00. Cruising range — 2 hours, 2 speeds forward, 2 speeds reverse. Complete with depth meter and compass. NAUTILUS, Deluxe Cat. No. 1996... Retail \$2,500.00. Clear plexiglass canopy, cruising range — 4 hours. 2 speeds forward, 2 speeds reverse. Complete with depth meter, compass, 2 SCUBAIR diving units, and built in tanks. Both models are manufactured by C.O.S.M.O.S., Italy, and are available through all HEALTHWAYS dealers.

## DIVING BOATS

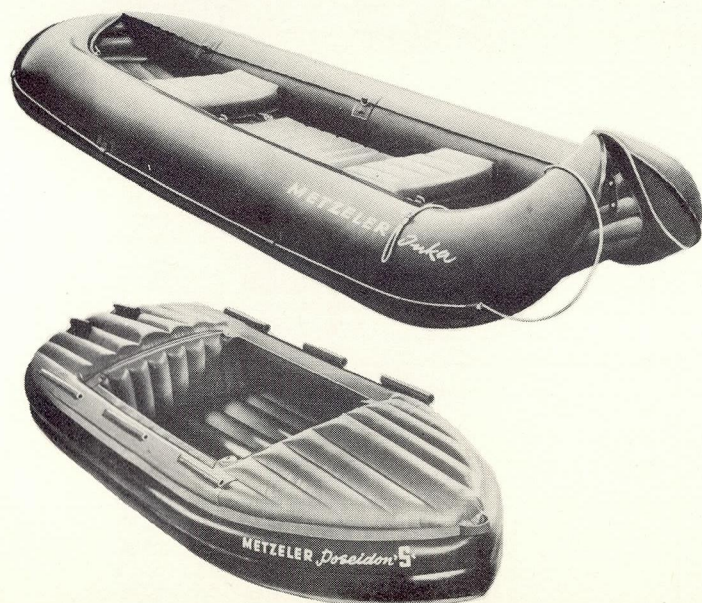

**Cat. No. 3212**  
**THE INKA BOAT**  
Retail \$165.00

Extra heavy duty canvas, completely rubberized inside and out. The boat for the hunter, the skindiver or as a auxiliary boat for the yachtsman. Inflatable in minutes. Can be used with outboard motor. Folds into shoulder carrying bag.

**Cat. No. 3214**  
**THE POSEIDON SUPER BOAT**  
Retail \$175.00

Two or three seater. Extra heavy duty canvas, completely rubberized inside and out. The family and sports boat. Can be used with outboard motor. Inflatable in minutes. Folds into shoulder carrying bag.

# UNDERWATER EXPOSURE SUITS

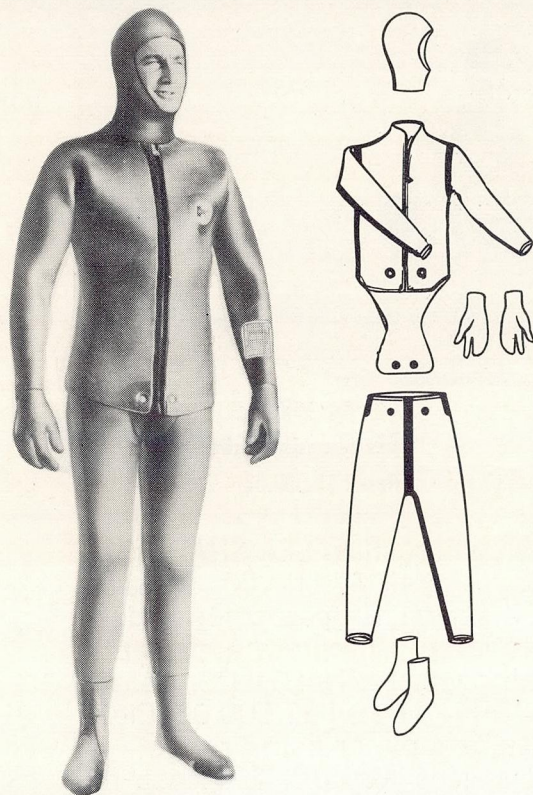

With your diving safety in mind, Healthways has attached an exclusive decompression chart on the arm of each Coronado Deluxe complete suit.

This chart gives you the maximum diving time at a given depth with no decompression and maximum diving time with decompression only at ten feet.

For prolonged dives at greater depths, we recommend Cat. No. 1973 Automatic Decompression Meter.

## CORONADO DELUXE FOAM NEOPRENE SUIT

Made of 3/16" heavy duty, high stretch material—skin on two sides. (Includes hood, long shirt with supporter apron, exclusive butterfly-seal collar and long pants, gloves and boots. Exclusive new "Easy-to-put-on" design with full length new heavy duty, giant zipper on shirt front.

COMPLETE SUITS			SHIRTS ONLY			PANTS ONLY		
Cat. No.	Size	Retail	Cat. No.	Size	Retail	Cat. No.	Size	Retail
1750	X-Small	\$51.50	1750-01	X-Small	\$24.00	1750-02	X-Small	\$22.00
1767	Small	51.50	1767-01	Small	24.00	1767-02	Small	22.00
1768	Medium	51.50	1768-01	Medium	24.00	1768-02	Medium	22.00
1769	Large	51.50	1769-01	Large	24.00	1769-02	Large	22.00
1751	X-Large	51.50	1751-01	X-Large	24.00	1751-02	X-Large	22.00

HOODS ONLY			GLOVES ONLY			BOOTS ONLY		
Cat. No.	Size	Retail	Cat. No.	Size	Retail	Cat. No.	Size	Retail
1767-04	Small	\$4.00	1767-06	Small	\$4.00	1767-05	Small	\$4.00
1768-04	Medium	4.00	1768-06	Medium	4.00	1768-05	Medium	4.00
1769-04	Large	4.00	1769-06	Large	4.00	1769-05	Large	4.00

## SIZE CHART FOR ALL HEALTHWAYS SUITS

	Waist	Weight	Height
Extra Small	26" -30"	100-135	5'2" -5'6"
Small	30" -34"	135-160	5'5" -5'9"
Medium	32" -36"	155-180	5'7" -6'0"
Large	34" -38"	175-210	5'10" -6'1"
Extra Large	38" -42"	210-240	6'0" -6'4"

### CORONADO DELUXE FOAM NEOPRENE SUIT

Made of 1/4" heavy duty, high stretch material—skin on two sides. (Includes hood, long shirt with supporter apron, exclusive butterfly-seal collar and long pants and boots. Exclusive new "Easy-to-put-on" design with full length new heavy duty, giant zipper on shirt front.

#### COMPLETE SUITS

Cat. No.	Size	Retail
1863	X-Small	\$57.50
1864	Small	57.50
1865	Medium	57.50
1866	Large	57.50
1867	X-Large	57.50

### 3/16" CORONADO DELUXE FOAM NEOPRENE SUIT WITH ZIPPERS IN ARMS AND LEGS

Cat. No.	Size	Retail
1770	X-Small	\$54.50
1771	Small	54.50
1772	Medium	54.50
1773	Large	54.50
1774	X-Large	54.50

### 1/4" CORONADO DELUXE FOAM NEOPRENE SUIT WITH ZIPPERS IN ARMS AND LEGS

Cat. No.	Size	Retail
1868	X-Small	\$60.50
1869	Small	60.50
1870	Medium	60.50
1871	Large	60.50
1872	X-Large	60.50

# UNDERWATER EXPOSURE SUITS

## DO-IT-YOURSELF KITS

**CORONADO FOAM NEOPRENE SUIT "DO-IT-YOURSELF" KIT.** Made of 1/8" high stretch material. All material is pre-cut—comes complete with cement, stripping and detailed instructions. Heavy duty brass zipper and buttons already installed.

Cat. No.	Size	Retail
1752	X-Small	\$29.95
1754	Small	29.95
1755	Medium	29.95
1756	Large	29.95
1753	X-Large	29.95



**CORONADO DELUXE FOAM NEOPRENE "DO-IT-YOURSELF" KIT.** Made of 3/16" heavy duty high stretch material. All material is pre-cut—comes complete with cement, stripping and detailed instructions. Heavy duty brass zipper and buttons already installed.

Cat. No.	Size	Retail
1748	X Small	\$43.50
1764	Small	43.50
1765	Medium	43.50
1766	Large	43.50
1749	X-Large	43.50

## CORONADO DELUXE FOAM NEOPRENE "DO-IT-YOURSELF" KIT.

Made of 1/4" extra heavy duty high stretch material. All material pre-cut. Comes complete with cement, stripping and detailed instructions. Heavy duty brass zipper and buttons already installed.

Cat. No.	Size	Retail
1853	X-Small	\$51.50
1854	Small	51.50
1855	Medium	51.50
1856	Large	51.50
1857	X-Large	51.50

## 3/16" BALBOA FOAM NEOPRENE JACKET

Cat. No.	Size	Retail
2774	X-Small	\$20.50
2770	Small	\$20.50
2771	Medium	\$20.50
2772	Large	\$20.50
2773	X-Large	\$20.50



## 3/16" AQUAFEMME

Woman's Water Ski and Skin Diving Jacket  
Foam Neoprene with Yellow collar and trim.

Cat. No.	Size	Retail
2800	X-Small	\$20.50
2801	Small	\$20.50
2802	Medium	\$20.50
2803	Large	\$20.50
2804	X-Large	\$20.50

**Cat. No. 1798**  
**ORIGINAL BLACK MAGIC**  
**FOAM NEOPRENE CEMENT**  
Retail \$1.25



**Cat. No. 1794**  
**CORONADO REPAIR KIT**  
Retail \$2.50

**Cat. No. 1791**  
**RUBBER DUST**  
(Concentrated powdered  
hydrous silicate of  
magnesium talc)  
Retail \$ .60



# SCUBA STAR REGULATOR REPLACEMENT PARTS

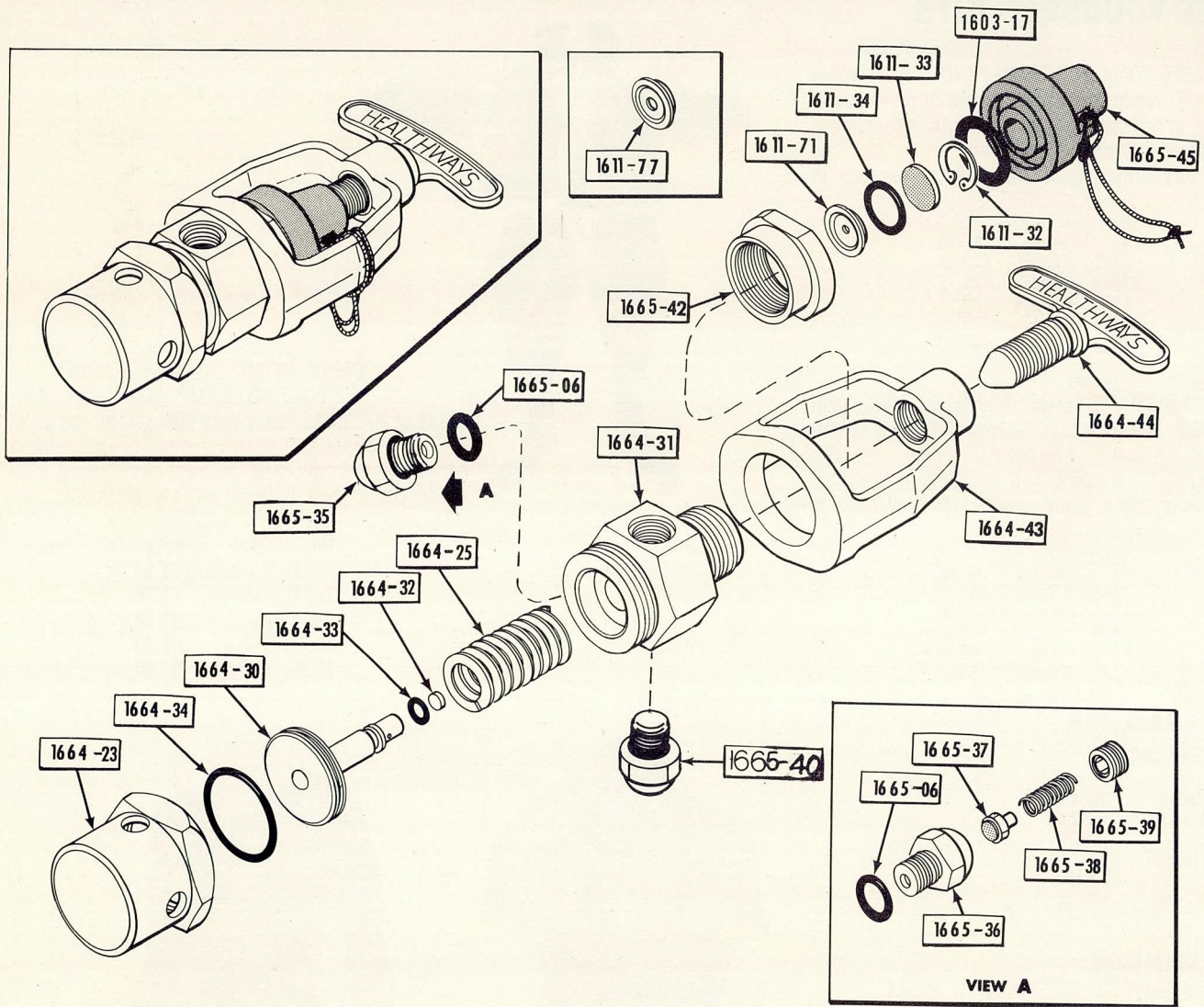

## NO. 1664-65 SCUBA-STAR REGULATOR FIRST STAGE

CAT. NO.	DESCRIPTION	RETAIL	CAT. NO.	DESCRIPTION	RETAIL
1611-32	Retaining Ring	\$ .50	1664-42	Yoke Nut — Chrome Finish	.80
1611-33	Sintered Filter	.50	1664-43	Yoke — Chrome Finish	4.00
1611-34	Restrictor "O" Ring	.25	1664-44	Yoke Screw — Chrome Finish	1.50
1611-71	"K" Restrictor	.90	1665-06	"O" Ring Synthetic Rubber	.25
1611-77	"J" Restrictor	.90	1665-35	Safety Relief Valve Assembly	2.50
1664-23	Cap, Brass, Chrome Finish	2.75	1665-36	Housing Stainless Steel	1.50
1664-25	Spring, Stainless Steel	.75	1665-37	Low Pressure Relief Valve Plunger	.15
1664-31	Body, Brass, Chrome Finish	7.50	1665-38	Low Pressure Relief Valve Spring	.10
1664-30	Piston, Brass, Chrome Finish	1.00	1665-39	Low Pressure Relief Valve Adjusting Screw	.15
1664-32	Seat — Teflon	.25	1665-40	Pressure Plug	.50
1664-33	"O" Ring, Small, Synthetic Rubber	.25	1665-45	Protection Cap Assembly	.75
1664-34	"O" Ring, Large, Synthetic Rubber	.25	1664-65	FIRST STAGE, COMPLETE	17.50

Healthways

LOS ANGELES, CALIF. • CHICAGO, ILL. • PENNSAUKEN, N. J.



# SCUBA STAR REGULATOR REPLACEMENT PARTS

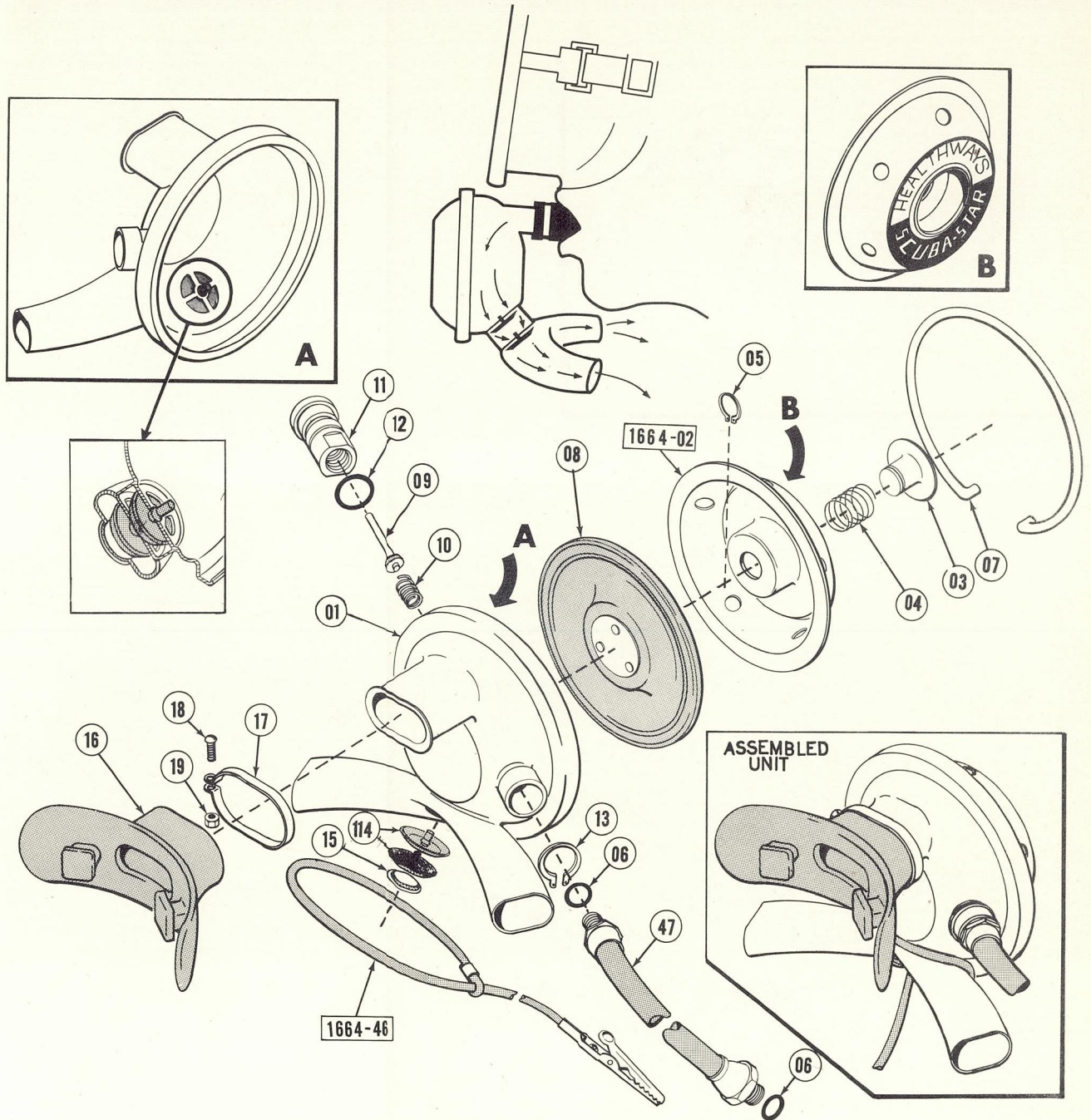

## NO. 1664-66 SCUBA-STAR REGULATOR SECOND STAGE

CAT. NO.	DESCRIPTION	RETAIL	CAT. NO.	DESCRIPTION	RETAIL
1665-101	Case	\$6.75	1665-11	Swivel Attachment	1.10
1664-02	Cover Assembly	5.25	1665-12	Swivel "O" Ring	.10
1664-46	Safety Lanyard Assembly	.75	1665-13	Swivel Retainer	.25
1665-03	Purging Button, Bright Chrome Finish	.60	1665-114	Exhaust Valve(2 Required)	.25
1665-04	Purging Button Spring	.10	1665-15	Exhaust Plug	.15
1665-05	Purging Button Retainer	.10	1665-16	Mouthpiece-Neoprene	.60
1665-06	"O" Ring for Hose Assembly	.35	1665-17	Stainless Steel Clamp	.10
1665-07	Quik-Klip	1.15	1665-18	Bolt for Clamp	.10
1665-08	Demand Diaphragm Assembly	1.50	1665-19	Nut for Clamp	.10
1665-09	Tilt Valve Assembly	1.00	1665-47	Hose Assembly	5.00
1665-10	Tilt Valve Spring	.10	1664-66	SECOND STAGE, COMPLETE	22.50

# SCUBAIR REGULATOR REPLACEMENT PARTS

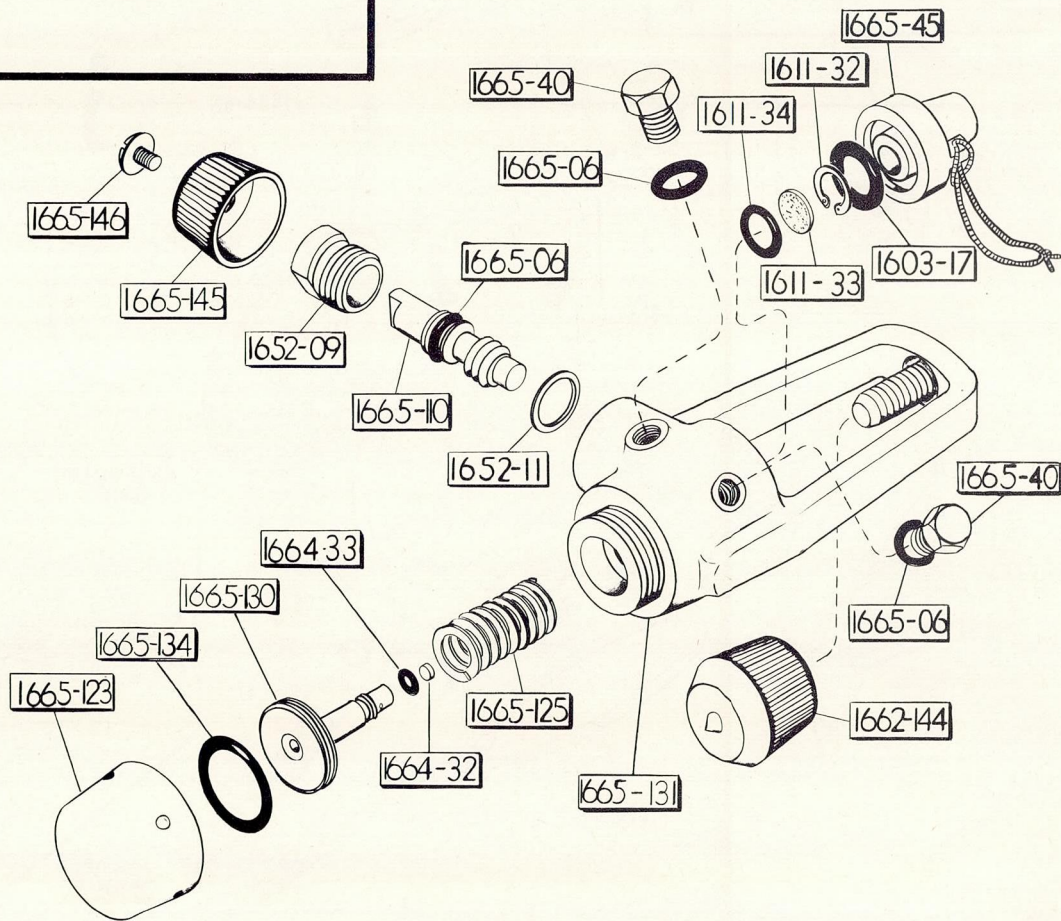
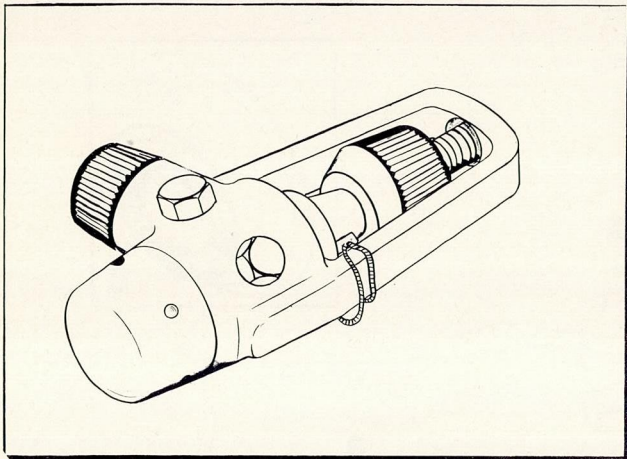

## SCUBAIR REGULATOR, FIRST STAGE—CAT. NO. 1665-165

CAT. NO.	DESCRIPTION	RETAIL
1603-17	"O" Ring, Outlet	\$.40
1611-32	Retainer Ring	.50
1611-33	Sintered Filter	.50
1611-34	Sintered Filter "O" Ring	.25
1652-09	Packing Nut	1.45
1652-11	Packing Nut Gasket	.15
1665-125	Spring, Stainless Steel	.75
1665-130	Piston Chrome-Plated Brass	1.00
1664-32	Seat, Teflon	.25
1664-33	"O" Ring, Small	.25
1665-134	"O" Ring, Large	.25

CAT. NO.	DESCRIPTION	RETAIL
1665-06	"O" Ring	\$.25
1665-40	Pressure Plug	.50
1665-45	Protection Cap, Assembly	.75
1665-113	Reserve Stem	2.70
1665-131	Body, Chrome-Plated Brass	12.95
1665-145	Reserve Control Knob	2.00
1665-146	Reserve Control Knob Screw	.35
1665-123	Cap, Chrome-Plated Brass	3.00
1662-144	"SAFE-LOCK" WHEEL	2.25
1665-165	First Stage, Complete	27.50

# SCUBAIR REGULATOR REPLACEMENT PARTS

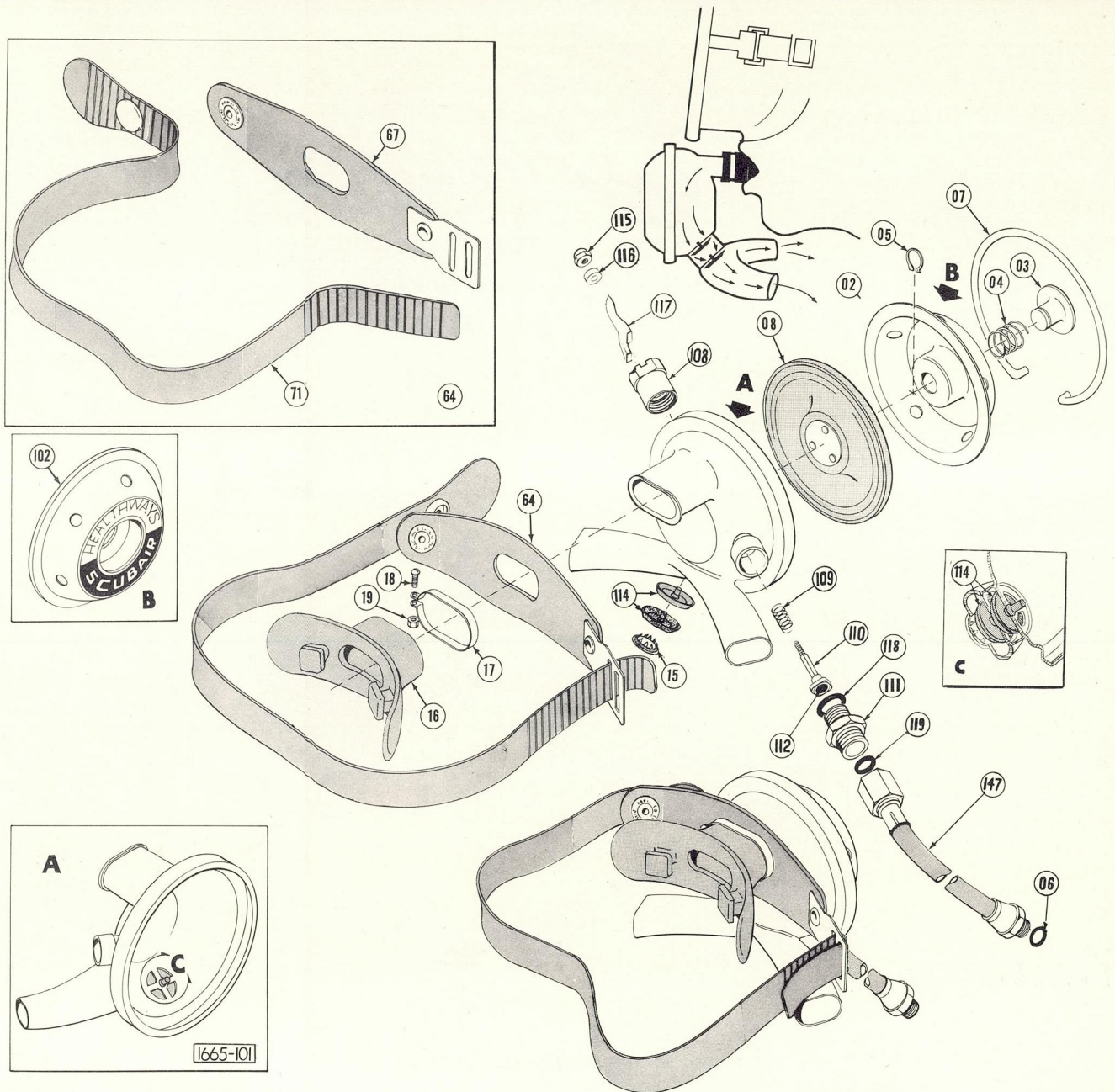

## SCUBAIR REGULATOR, SECOND STAGE—CAT. NO. 1665-166

CAT. NO.	DESCRIPTION	RETAIL	CAT. NO.	DESCRIPTION	RETAIL
1665-101	Case	\$6.75	1665-16	Black Neoprene Mouthpiece	\$ .60
1665-102	Cover Assembly	5.25	1665-17	Stainless Clamp	.10
1665-03	Purging Button	.60	1665-18	Bolt for Stainless Clamp	.10
1665-04	Purging Button Spring	.10	1665-118	Valve Assembly "O" Ring	.35
1665-05	Purging Button Retainer	.10	1665-19	Nut for Stainless Clamp	.10
1665-06	"O" Ring-Hose	.25	1665-119	Swivel Fitting "O" Ring	.35
1665-07	"QUIK-KLIP"	1.15	1665-115	Adjustment Nut	.10
1665-08	Demand Diaphragm Assembly	1.50	1665-116	Spacer	.15
1665-108	Demand Valve Body	2.50	1665-117	Demand Lever	.75
1665-109	Demand Valve Spring	.50	1665-147	Hose Assembly	6.50
1665-110	Demand Valve	1.50	1665-64	Mouthpiece Strap Assembly	2.50
1665-111	Demand Valve Housing	1.50	1665-67	Mouthpiece Guard, Complete	1.50
1665-112	Demand Valve Seat	.25	1665-71	Mouthpiece Band	1.00
1665-114	Exhaust Valve (2 required)	.25	1665-166	Scuba Air Regulator, Second Stage, Complete	22.50
1665-15	Exhaust Plug	.15			

# SCUBA REGULATOR REPLACEMENT PARTS



SELF-CONTAINED UNDERWATER  
BREATHING APPARATUS

## REGULATOR

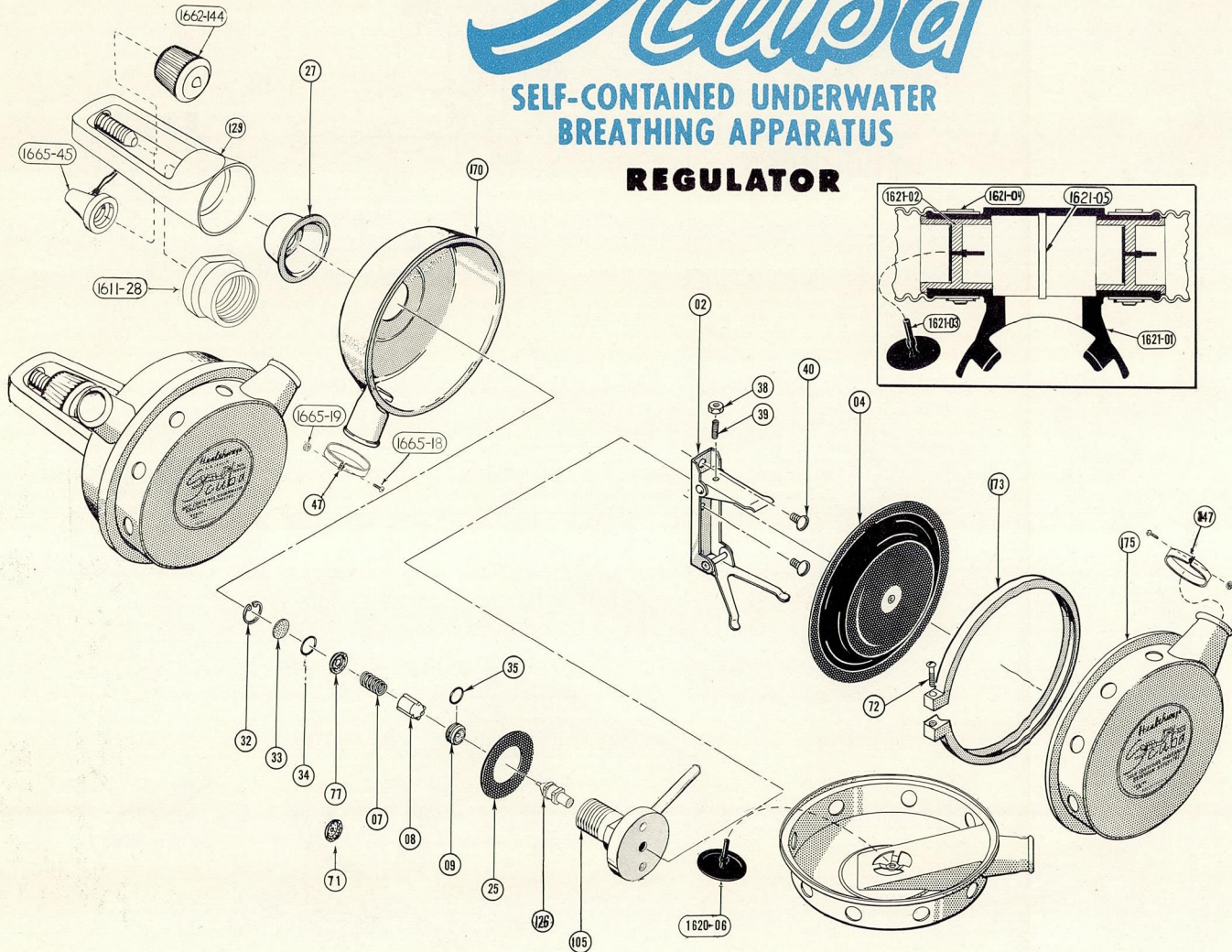

CATALOG NO. 1611—SCUBA REGULATOR "MODEL 1962"

CAT. NO.	DESCRIPTION	RETAIL	CAT. NO.	DESCRIPTION	RETAIL
1601-01	Rubber Hose (one only)	\$2.50	1611-175	SCUBA Cover Assembly	12.00
1603-17	"O" Ring	.40	1611-77	"J" Restrictor	.90
1611-02	SCUBA Linkage Assembly	2.75	1611-105	Valve Body Assembly	6.00
1611-04	SCUBA Diaphragm Assembly	4.50	1611-106	Valve Body Cover Plate	1.50
1611-07	Valve Spring, stainless steel	.25	1611-129	Yoke, chrome plated brass	6.00
1611-08	Valve Plunger, nylon	.75	1611-147	Hose Clamp, stainless steel (2 Required)	.20
1611-09	Valve Seat, nickle plated brass	1.50	1611-170	Case, chrome plated brass	12.00
1611-25	Gasket, Neoprene	.25	1611-173	Cover Clamp, chrome plated brass	1.95
1611-126	Actuating Pin, stainless steel	1.25	1620-06	Rubber Flapper Valve	.25
1611-27	Spacer, chrome plated brass	1.00	1621-01	Mouthpiece Body, rubber	3.00
1611-32	Retaining Ring, nickle plated copper	.50	1621-02	Nylon Insert	.25
1611-33	Sintered Filter, nickle plated copper	.50	1621-03	Non-return rubber valve	.25
1611-34	Restrictor "O" Ring	.25	1621-04	Mouthpiece Clamp	.50
1611-35	Valve Seat "O" Ring	.25	1621-05	Baffle	.50
1611-38	Hex Nut, #10-32, stainless steel	.25	1662-144	Safe-lock Wheel	2.25
1611-39	Set Screw, #10-32, stainless steel	.25	1665-18	Bolt for Stainless Clamp (mouthpiece and hose)	.10
1611-40	Machine Screws, #10-32 x 5/16" stainless steel	.25		(4 required)	
1611-71	"K" Restrictor	.90	1665-19	Nut for Stainless Clamp (mouthpiece and hose)	.10
1611-172	Cover Clamp Screw, #8-32 x 5/8" stainless steel	.50		(4 required)	
			1665-45	Protection Cap Assembly	.75

# VALVE REPLACEMENT PARTS

## PROFESSIONAL HIGH PRESSURE VALVE FOR DOUBLE TANK ASSEMBLY—CAT. NO. 1609

CAT. NO.	DESCRIPTION	RETAIL
1603-17	"O" Ring, Outlet	\$ .40
1609-05	Elbow Body (right hand thread)	10.00
1652-01	Safety Plug	.45
1652-03	Safety Gasket	.10
1652-04	Safety Disc	.35
1652-06	Seat Assembly	2.00
1652-07	Control Wheel	3.00
1652-08	Stem Nut	.65
1652-09	Packing Nut	1.45
1652-10	Stem	2.70
1652-11	Packing Nut Gasket	.15
1652-12	Stem Spring	.45
1652-13	Teflon Packing	.50
1652-14	Teflon Wheel Washer	.30
1653-06	Center Body	15.50
1653-08	Elbow Body (left hand thread)	10.00
1653-09	Lock Nut (right hand thread)	.65
1653-10	Nipple "O" Ring	.45
1653-11	Teflon Back-Up Ring	.55
1653-12	Lock Nut (left hand thread)	.65
1665-06	"O" Ring	.25
1665-40	Pressure Plug	.50

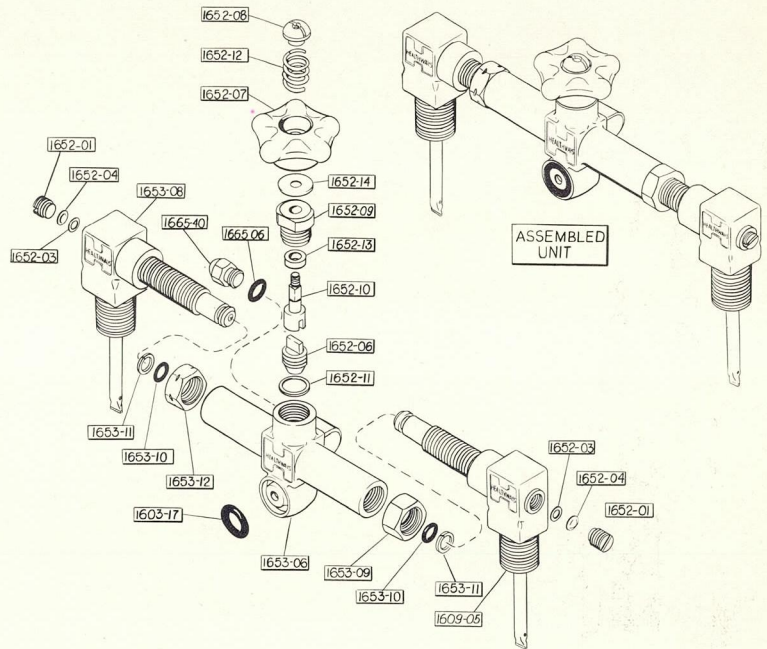

## PROFESSIONAL SCUBA CONSTANT AIR RESERVE VALVE FOR DOUBLE TANK ASSEMBLY—CAT. NO. 1653

CAT. NO.	DESCRIPTION	RETAIL
1603-17	"O" Ring	\$ .40
1652-01	Safety Plug	.45
1652-03	Safety Gasket	.10
1652-04	Safety Disc	.35
1652-06	Seat Assembly	2.00
1652-07	Control Wheel	3.00
1652-08	Stem Nut	.65
1652-09	Packing Nut	1.45
1652-10	Stem	2.70
1652-11	Packing Nut Gasket	.15
1652-12	Stem Spring	.45
1652-13	Teflon Packing	.50
1652-14	Teflon Wheel Washer	.30
1653-06	Center Body	15.50
1653-07	Reserve Body (right hand thread)	14.25
1653-08	Elbow Body (left hand thread)	10.00
1653-09	Lock Nut (right hand thread)	.65
1653-10	Nipple "O" Ring	.45
1653-11	Teflon Back-Up Ring	.55
1653-12	Lock Nut (left hand thread)	.65
1654-15	Reserve Spline	1.45
1654-16	Reserve Lever	4.25
1654-18	Reserve Lever Washer	.15
1654-20	Reserve Mechanism Assembly	1.50
1654-21	Click Pin	.30
1654-22	Click Pin Spring	.15
1665-06	"O" Ring	.25
1665-40	Pressure Plug	.50
1643	Pull Rod	1.25

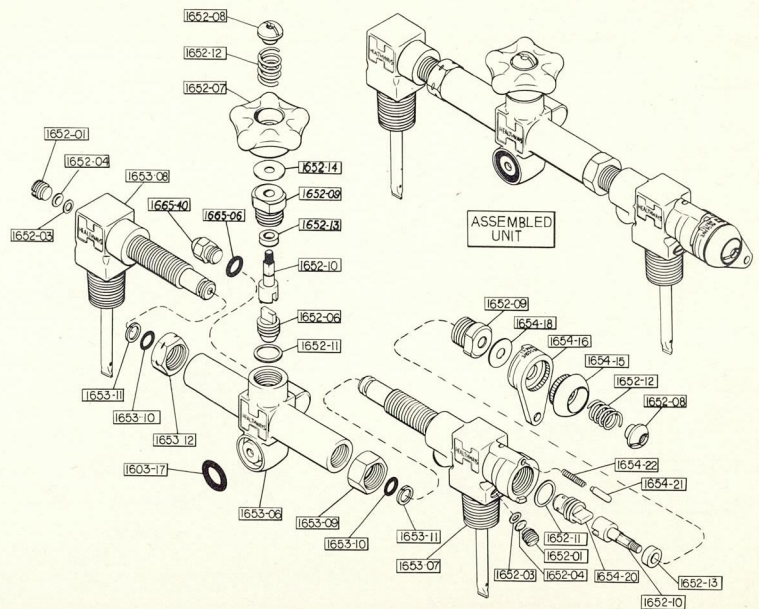



# VALVE REPLACEMENT PARTS

## NO. 1603 — HIGH PRESSURE VALVE

CAT. NO.	DESCRIPTION	RETAIL
1603-13	Safety Plug	\$ .40
1603-17	"O" Ring, Inlet	.40
1603-21	Body	3.50
1603-22	Stem	1.25
1603-23	Packing Nut	1.10
1603-24	Seat Assembly	1.75
1603-25	Wing Nut	1.75
1603-26	Packing	.35
1603-27	Stem Nut	.50
1603-28	Stem Spring	.30
1603-29	Lock Washer	.10
1603-30	Gasket	.10
1603-31	Disc	.10
1603-32	H.P. Gauge Plug "K"	.75
1665-06	"O" Ring, H.P. Gauge Plug	.40

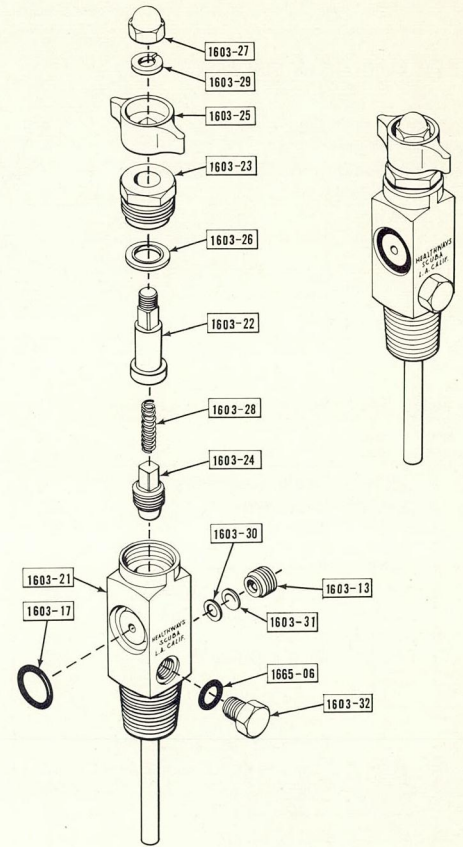

## NO. 1623 — SCUBA CONSTANT AIR RESERVE VALVE

CAT. NO.	DESCRIPTION	RETAIL
1603-13	Safety Plug	\$ .40
1603-30	Gasket	.10
1603-31	Disc	.10
1603-17	"O" Ring — Inlet	.40
1623-01	H.P. Gauge Plug "J"	.75
1665-06	"O" Ring H.P. Gauge Plug	.40
1623-02	Body	20.00
1623-03	Reserve Packing Nut	1.60
1623-05	Reserve Lever	3.40
1623-04	Stem	1.80
1623-06	Spline	1.15
1623-07	Packing Nut Gasket	.20
1623-08	Packing Nut	1.10
1623-09	Wing Nut	2.00
1623-10	Stem Nut	.65
1623-12	Stem Spring	.30
1623-13	Teflon Packing	.10
1623-14	Pin Spring	.20
1623-15	Click Pin	.30
1623-16	Reserve Lever Washer	.20
1623-17	Wing Nut Washer	.10
1623-18	Reserve mechanism Assembly	1.90
1623-19	Seat Assmly	1.10

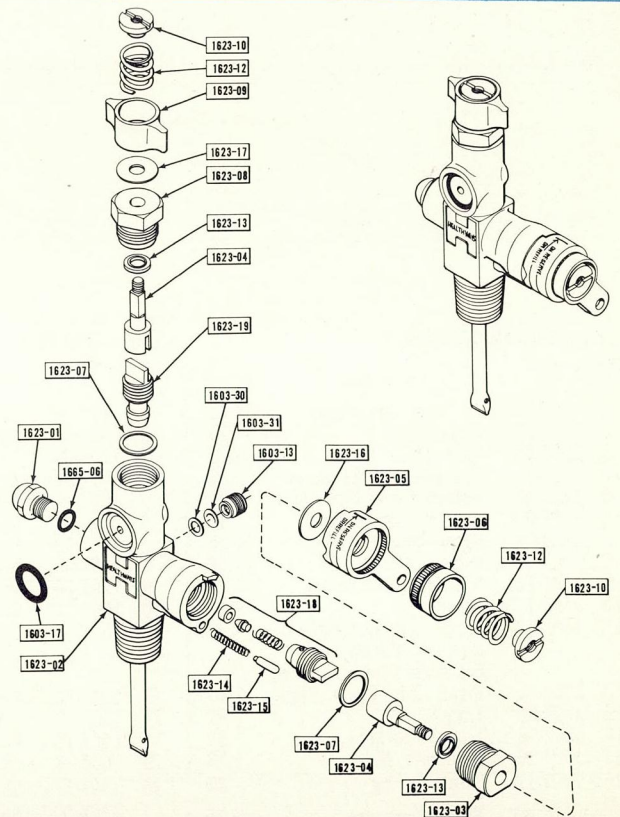

# SPEARGUN REPLACEMENT PARTS

## SHARK SLING SPEAR GUN PARTS

Cat. No.	Item	Retail
1502-08	Power Sling	\$ .80
1502-04	Standard Spear	1.75
1502-25	Gun Only (No Spear)	2.75

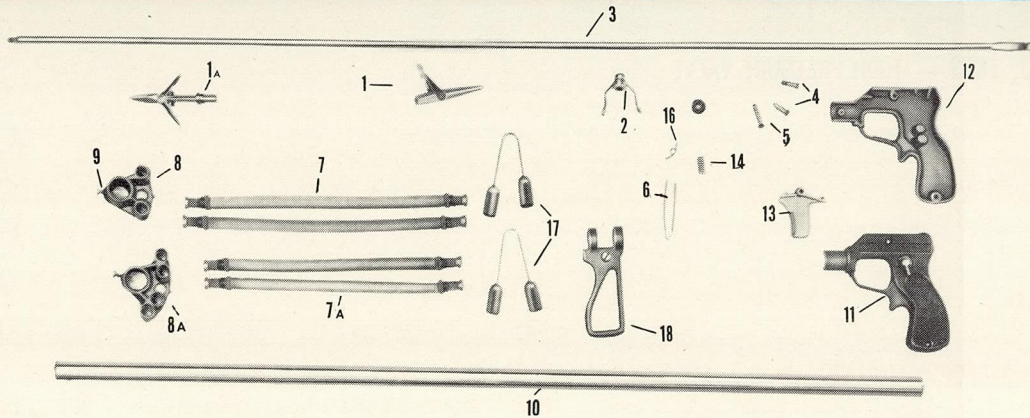

## 1504—PECHE SPORT JUNIOR ARBALETE

Illust. No.	Cat. No.	Description	*Retail
1	1504-02	Single Barb Spearhead	\$ .98
2	1504-03	Slide Ring	.40
3	1504-04	Bare Shaft	1.85
4	1504-05	Machine Screws (2 req.)	.15
5	1504-06	Barrel Screw	.32
6	1504-07	Spring Clamp Wire	.32
7	1504-08	Power Rubber 1 pr. 1/2 set	1.60
8	1504-09	Muzzle	3.43
9	1504-10	Muzzle Screw	.10
10	1504-11	Barrel	6.44
11	1504-13	Pistol Grip Casting Includes Safety Lever, Eccentric Disc and Spring.	12.18
12	1504-16	Pistol Grip Cover Plate	1.40
13	1504-18	Trigger	1.28
14	1504-19	Trigger Spring	.32
16	1507-17	Safety Spring	.32
17	1504-26	Wishbone Wire	1.25
	1504-60	Spear Shaft Complete	3.80

## 1505—PECHE SPORT STANDARD ARBALETE

Illust. No.	Cat. No.	Description	Retail
1	1505-02	Double Barb Spearhead	\$1.98
2	1504-03	Slide Ring	.40
3	1505-04	Bare Shaft	2.30
4	1504-05	Machine Screws (2 req.)	.15
5	1504-06	Barrel Screw	.32
6	1504-07	Spring Clamp Wire	.32
7	1505-08	Power Rubber 1 pr. 1/2 set	1.85
8	1504-09	Muzzle	3.43
9	1504-10	Muzzle Screw	.10
10	1504-11	Barrel	6.44
11	1504-13	Pistol Grip Casting Includes Safety Lever, Eccentric Disc and Spring.	12.18
12	1504-16	Pistol Grip Cover Plate	1.40
13	1504-18	Trigger	1.28
14	1504-19	Trigger Spring	.32
16	1507-17	Safety Spring	.32
17	1504-26	Wishbone Wire	1.25
	1505-60	Spear Shaft Complete	4.45

## 1506—PECHE SPORT DELUXE ARBALETE

Illust. No.	Cat. No.	Description	Retail
1	1505-02	Double Barb Spearhead	\$1.98
2	1504-03	Slide Ring	.40
3	1506-04	Bare Shaft	2.60
4	1504-05	Machine Screws (2 req.)	.15
5	1504-06	Barrel Screw	.32
6	1506-07	Spring Clamp Wire	.32
7	1506-08	Power Rubber 1 pr. 1/4 set	1.85
7a	1505-08	Power Sling 1 pr. 1/4 set	1.85
8a	1506-09	Muzzle	4.97
9	1504-10	Muzzle Screw	.10
10	1506-11	Barrel	7.84
11	1504-13	Pistol Grip Casting Includes Safety Lever, Eccentric Disc and Spring.	12.18
12	1504-16	Pistol Grip Cover Plate	1.40
13	1504-18	Trigger	1.28
14	1504-19	Trigger Spring	.32
16	1507-17	Safety Spring	.32
17	1504-26	Wishbone Wire	1.25
18	1506-27	Center Grip Handle	3.50
	1506-60	Spearshaft Complete	5.00

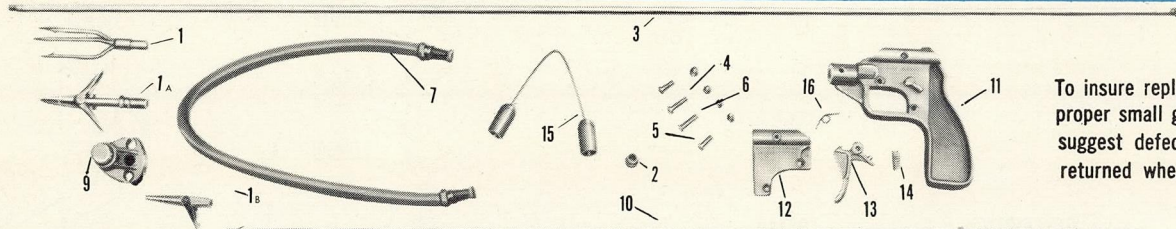

To insure replacement of proper small gun parts we suggest defective part be returned when ordering.

## 1507—BANTAM ESPADON

Illust. No.	Cat. No.	Description	Retail
1	1507-02	Tri Point Spearhead	\$1.75
2	1507-03	Slide Ring	.20
3	1507-04	Bare Shaft	1.34
4	1507-05	Top Cover Plate Screw	.15
5	1507-06	Bottom Cover Plate Screw	.15
6	1507-07	Rear Barrel Screw	.15
7	1507-08	Power Sling	2.25
8	1507-09	Muzzle	.50
9	1507-10	Muzzle Barrel Screw	.15
10	1507-11	Barrel	4.46
11	1507-13	Pistol Grip Casting Includes: Safety Lever, Eccentric Disc and Spring.	4.79
12	1507-16	Pistol Grip Cover Plate	1.40
13	1507-18	Trigger	.83
14	1507-19	Trigger Spring	.32
15	1507-26	Wishbone Wire	1.25
16	1507-17	Safety Spring	.32
	1507-60	Shaft Complete	3.35

## 1508—JUNIOR ESPADON

Illust. No.	Cat. No.	Description	Retail
1B	1504-02	Single Barb Spearhead	\$ .98
2	1507-03	Slide Ring	.20
3	1508-04	Bare Shaft	1.50
4	1507-05	Top Cover Plate Screw	.15
5	1507-06	Bottom Cover Plate Screw	.15
6	1507-07	Rear Barrel Screw	.15
7	1508-08	Power Sling	2.50
8	1507-09	Muzzle	.50
9	1507-10	Muzzle Barrel Screw	.15
10	1508-11	Barrel	6.00
11	1507-13	Pistol Grip Casting Includes: Safety Lever, Eccentric Disc and Spring.	4.79
12	1507-16	Pistol Grip Cover Plate	1.40
13	1507-18	Trigger	.83
14	1507-19	Trigger Spring	.32
15	1504-26	Wishbone Wire	1.25
16	1507-17	Safety Spring	.32
	1508-60	Spear Shaft Complete	3.15

## 1509—STANDARD ESPADON

Illust. No.	Cat. No.	Description	Retail
1B	1504-02	Single Barb Spearhead	\$ .98
2	1507-03	Slide Ring	.20
3	1509-04	Bare Shaft	1.60
4	1507-05	Top Cover Plate Screw	.15
5	1507-06	Bottom Cover Plate Screw	.15
6	1507-07	Rear Barrel Screw	.15
7	1509-08	Power Sling	2.50
8	1507-09	Muzzle	.50
9	1507-10	Muzzle Barrel Screw	.15
10	1509-11	Barrel	6.69
11	1507-13	Pistol Grip Casting Includes: Safety Lever, Eccentric Disc and Spring.	4.79
12	1507-16	Pistol Grip Cover Plate	1.40
13	1507-18	Trigger	.83
14	1507-19	Trigger Spring	.32
15	1504-26	Wishbone Wire	1.25
16	1507-17	Safety Spring	.32
	1509-60	Spear Shaft Complete	4.35



# SPEARGUN REPLACEMENT PARTS

## NO. 1520 DOUBLETTE

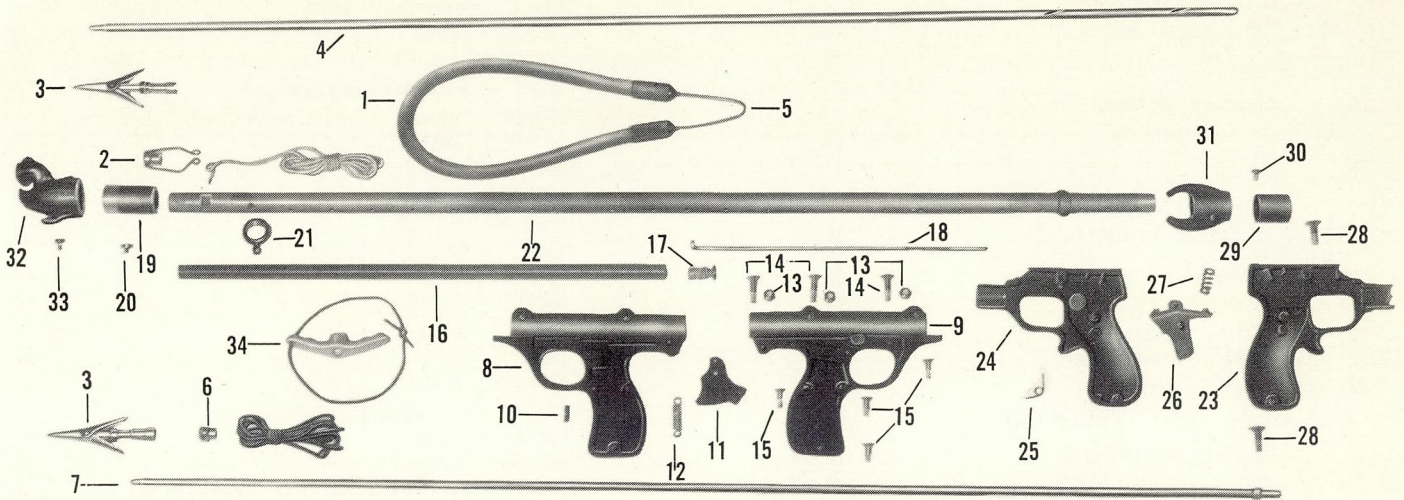

Illust. No.	Cat. No.	Description	Retail
1	1509-08	Power Sling	\$2.50
2	1504-03	Slide Ring for 1505-04 Shaft	.40
3	1505-02	Double Barb Spearhead	1.98
4	1505-04	Barbed Spearshaft (Rubber Powered)	2.30
5	1504-26	Wishbone Wire	1.25
6	1507-03	Slide Ring for 1520-04 Shaft	.20
7	1520-04	Bare Spearshaft (Spring Powered)	2.95
8	1520-05	Left Hand Pistol Grip Plate (Spring Gun)	3.00
9	1520-06	Right Hand Pistol Grip Plate (Spring Gun)	3.00
10	1520-07	Trigger Retainer Pin (Spring Gun)	.50
11	1520-08	Trigger (Spring Gun)	1.00
12	1520-09	Trigger Spring (Spring Gun)	.50
13	1520-10	Nuts for Spring Gun Pistol Grip	.10
14	1520-11	Bolts for Spring Gun Pistol Grip	.10
15	1520-12	Screws for Spring Gun Pistol Grip	.10
16	1520-13	Power Spring	3.50
17	1520-14	Power Spring Button	.75

Illust. No.	Cat. No.	Description	Retail
18	1520-15	Line Release Rod	1.00
19	1520-16	Spring Retainer	.50
20	1520-17	Spring Retainer Screw	.10
21	1520-18	Line Holder	1.35
22	1520-10	Barrel	15.00
23	1520-20	Left Hand Pistol Grip Plate (Rubber Power)	4.50
24	1520-21	Right Hand Pistol Grip Plate, includes safety lever and eccentric disc	4.50
25	1520-22	Eccentric Disc Spring	2.50
26	1520-23	Trigger (Rubber Power)	.75
27	1520-24	Trigger Spring (Rubber Power)	3.50
28	1520-25	Screws for Pistol Grip Plate (Rubber Power)	.10
29	1520-26	Adapter Cylinder for Pistol Grip	2.50
30	1520-27	Screw for Adapter Cylinder	.25
31	1520-28	Line Retainer	1.00
32	1520-29	Muzzle	2.50
33	1520-30	Muzzle Barrel Screw	.10

## NO. 1531 CRESSI SAETTA

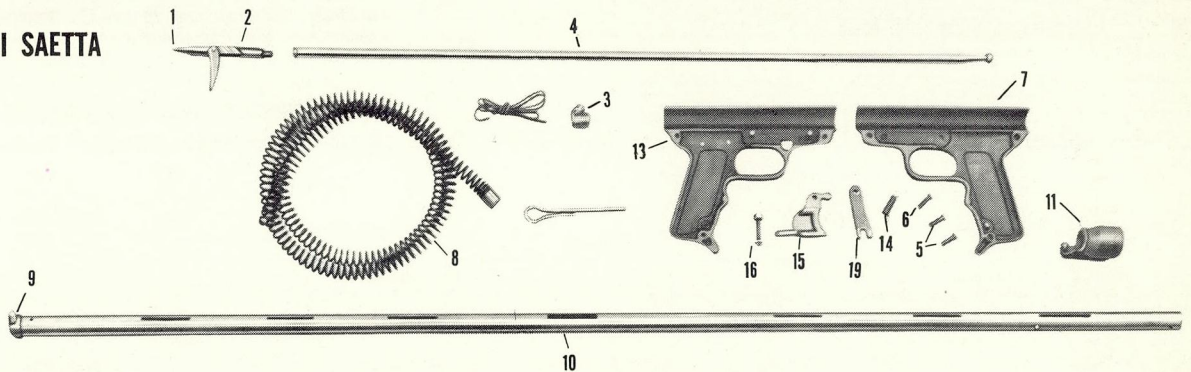

Illust. No.	Cat. No.	Description	Retail
1	1534-01	Spearhead Tip	\$ .40
2	1534-02	Single Barb Spearhead	1.25
3	1534-03	Slide Ring	.20
4	1531-04	Bare Shaft	2.96
5	1531-05	Top Grip Screw (3 req.)	.07
6	1531-06	Bottom Grip Screw	.07
7	1531-07	Right Hand Grip Plate	3.14
8	1531-08	Power Spring	4.21
9	1531-09	Front Line Hold	1.33

Illust. No.	Cat. No.	Description	Retail
10	1531-10	Barrel (Includes 09)	10.93
11	1531-11	Rear Line Holder	.74
13	1531-13	Left Hand Grip Plate	4.25
14	1531-14	Trigger Spring	.15
15	1531-15	Trigger	.96
16	1531-16	Line Clamp Screw & Nut	2.75
19	1531-19	Spear Release Plate	.89
	1531-60	Spear Complete	4.60

# MASKS, FINS and SNORKEL REPLACEMENT PARTS

CAT. NO.	DESCRIPTION	RETAIL EACH	CAT. NO.	DESCRIPTION	RETAIL EACH
<b>1201</b>	<b>Aqua Champ Special Mask</b>		<b>1302</b>	<b>Water Dogs — Small</b>	
1201-02	Styrene Lens (clear)	.25	1302-03	Strap	.28
1201-03	Straps	.10	1205-04	Buckles	.10
1201-04	Buckle	.10	<b>1303</b>	<b>Water Dogs — Medium</b>	
<b>1202</b>	<b>Aqua Champ Sr. Mask</b>		1303-03	Strap	.38
1202-02	Lens (shatterproof)	.25	1303-04	Buckles	.10
1201-03	Straps	.10	<b>1304</b>	<b>Water Dogs — Large</b>	
1201-04	Buckle	.10	1303-03	Strap	.38
<b>1211</b>	<b>Professional Deluxe Mask</b>		1303-04	Buckles	.10
1205-02	Lens (double strength glass)	.85	<b>1334</b>	<b>Genoa Fin — Large (9-11)</b>	
1211-03	Strap	.65	1334-03	Strap	.65
1205-04	Buckles	.06	1334-04	Buckle	.10
1205-60	Band complete	.65	<b>1335</b>	<b>Genoa Fin — X Large (11-13)</b>	
<b>1220 1250 1270</b>	<b>Espadon</b>		1335-03	Strap	.65
<b>1222 1252 1272</b>	<b>Panoramique</b>		1357-04	Buckle	.10
<b>1223 1253 1273</b>	<b>Compensator</b>		<b>1381</b>	<b>Rondine Adjustable Fins — Small (1-5)</b>	
-02	Lens-tempered safety glass	1.25	1381-03	Strap	.50
-03	Strap	.80	1381-04	Buckle	.15
-04	Buckles for strap	.10	<b>1382</b>	<b>Rondine Adjustable Fins — Medium (5-10)</b>	
-60	Band Assembly complete	.65	1382-03	Strap	.50
<b>1224</b>	<b>Panoramique Mask with "Clear-Ease" Valve</b>		1381-04	Buckle	.15
1224-02	Lens (tempered safety glass)	1.80	<b>1383</b>	<b>Rondine Adjustable Fins — Large (10-14)</b>	
1222-03	Strap	.80	1383-03	Strap	.50
1222-04	Buckles for strap	.10	1381-04	Buckle	.15
1222-60	Band Assembly complete	.65	<b>1403</b>	<b>Sea Scout Snorkel</b>	
1243-07	Cressi "Clear-Ease" Valve	2.00	1403-03	Mouthpiece	.25
<b>1239</b>	<b>Ostrica Junior Mask</b>		<b>1405</b>	<b>Sea Dive Standard Snorkel</b>	
1239-02	Lens (tempered safety glass)	1.25	1403-03	Mouthpiece	.25
1239-03	Strap	.65	1403-02	Cage	.30
1239-04	Buckles for strap	.10	1403-04	Ball	.10
<b>1240</b>	<b>Ostrica Bantam</b>		<b>1430</b>	<b>Delfino Snorkel</b>	
1240-02	Lens (tempered safety glass)	1.25	1430-07	Mouthpiece	1.30
1240-03	Strap	.50	1430-11	Gum Rubber Tube	.38
1240-04	Buckles for strap	.10	1430-05	Plastic Tube	.30
<b>1243</b>	<b>Pinocchio Professional "Model 1962" Mask</b>		<b>1432</b>	<b>Haiti Professional Snorkel</b>	
1243-02	Lens (tempered glass)	2.50	1432-07	Mouthpiece	1.00
1243-03	Strap	.85	1432-01	Tube	1.25
1243-04	Brass Buckle	.10	1432-07	Professional Snorkel Mouthpiece	1.00
1243-05	Stainless Steel Band Assembly	3.50	1938	SNORKEL HOLDER	1.00
1243-06	Clamp	.25		Fits all Healthways Snorkels	
<b>1261</b>	<b>Stabilizator "Clear-Ease" Mask</b>		<b>1962-01</b>	<b>PRESCRIPTION LENS HOLDER FRAME</b>	<b>3.50</b>
1261-02	Lens (tempered glass)	1.80	<b>1962-02</b>	<b>PRESCRIPTION LENS HOLDER SUCTION CUP</b>	<b>1.00</b>
1260-03	Strap	.80			
1220-04	Buckles	.10			
1222-60	Band Assembly complete	.65			
1261-06	One-way Valve	.25			

## Healthways Warehouses

HEALTHWAYS four strategically located factory facilities provide the most expeditious service throughout the western hemisphere. Los Angeles, California to service the western states; Chicago, Illinois to service the midwest; Pennsauken, New Jersey to service the east coast, and Toronto, Ontario to service Canada. Hamburg, Germany to service Western Europe and Melbourne, Australia to service the Far East. Outstanding product lines from a single source with liberal freight allowances program and consolidated shipments.

HEALTHWAYS assists you with unparalleled dealer support by national advertising, radio, television, point-of-purchase displays and advertising materials. HEALTHWAYS products are presented in inviting packaging, which has been awarded many national prizes.

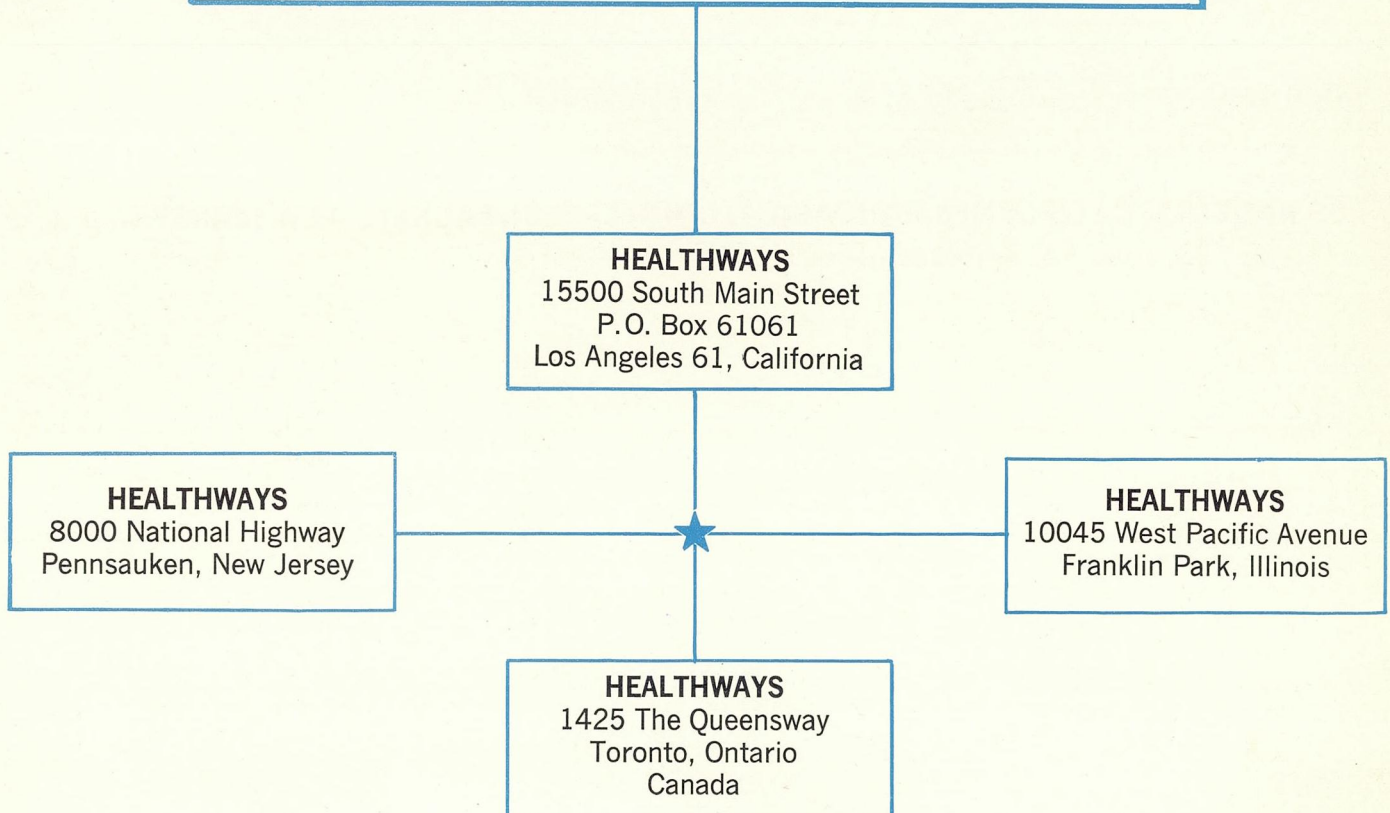

**SKIN AND SCUBA DIVING EQUIPMENT**

**WEIGHT LIFTING & EXERCISING EQUIPMENT**

**SURF, BEACH & CAMPING AIR MATTRESSES**

**GOLF ACCESSORIES**

**SPORT & TARGET PISTOLS**

**LOS ANGELES, CALIFORNIA/CHICAGO, ILLINOIS/PENNSAUKEN, NEW JERSEY**



**HEALTHWAYS**

*Direct all correspondence and orders to*

**HEALTHWAYS**

**P. O. Box 61061**

**Los Angeles 61, California**

**FAculty 1-8111**