

1965

# SKIN & SCUBA DIVING EQUIPMENT

*Jack*

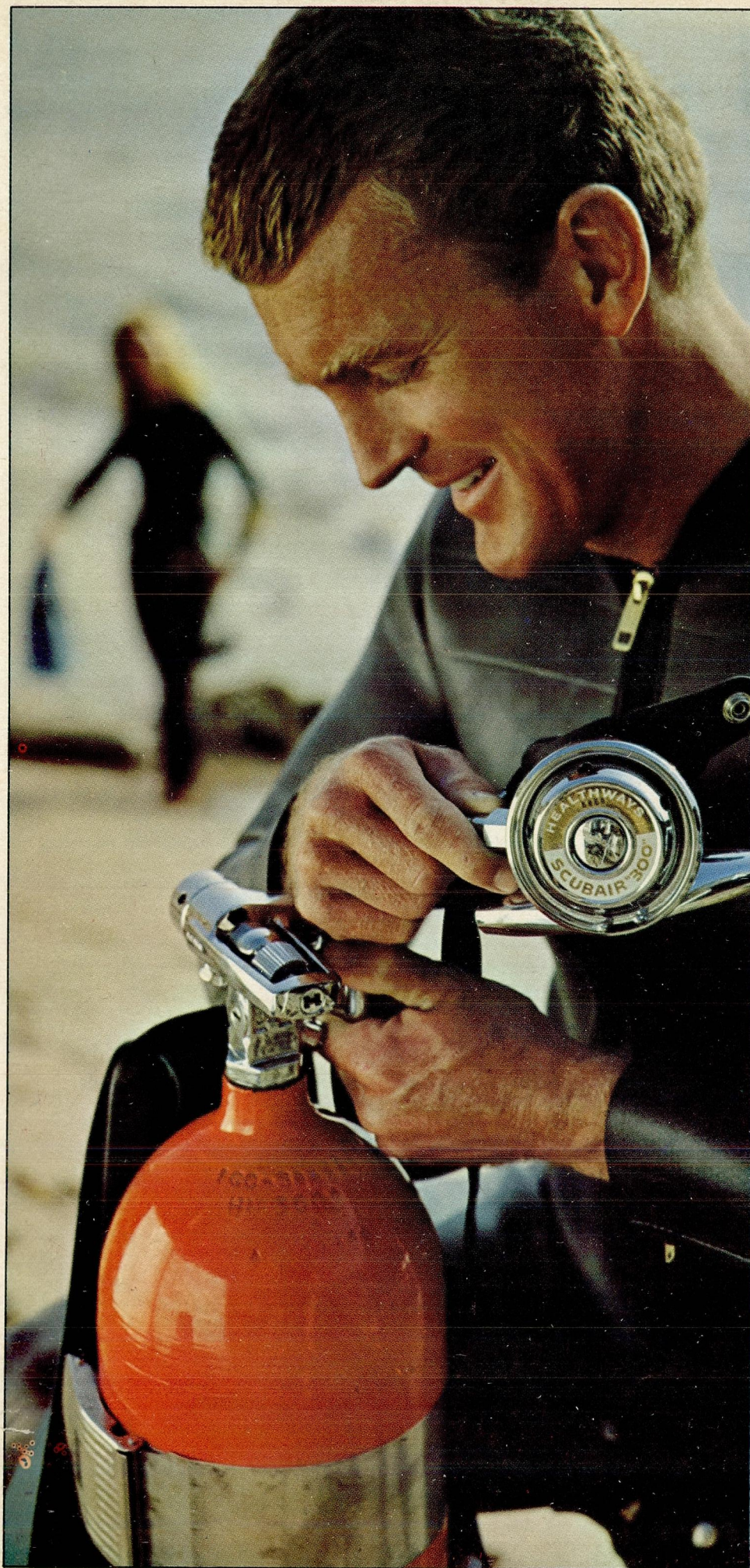





**DIVE MASKS 3-5**

---

**SNORKELS 6**

---

**RONDINE FINS 7-9**

---

**UNDERWATER EXPOSURE SUITS 10-11**

---

**REGULATORS 12-17**

---

**TANK ASSEMBLIES 18-19**

---

**SCUBAPACK HARNESSES 20**

---

**TANK VALVES AND ACCESSORIES 21-22**

---

**WEIGHT BELTS 23**

---

**SPEARFISHING GUNS 24-25**

---

**SPEARHEADS AND ACCESSORIES 26**

---

**DIVING ACCESSORIES 27-28**

---

**DIVING SAFETY SECTION 29-30**

---

**PACKAGING 31**



**SEA VIEW COMPETITION**

catalog no. 1229  
color **black**  
price **\$8.95**

The Sea View masks are specifically designed to provide the maximum in underwater vision. The new rectangular shape and slanted lens substantially increases the normal field of vision. Outstanding features: new "Snap-Lok" stainless steel band — safety glass lens — split head strap for secure fit — comfortable feather edge seal — neoprene nose pad for ear equalization. The Sea View "Clear-Ease" incorporates a large non-return valve for easy, fast clearing of the mask.

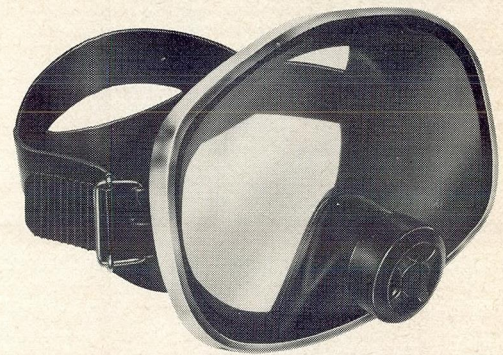
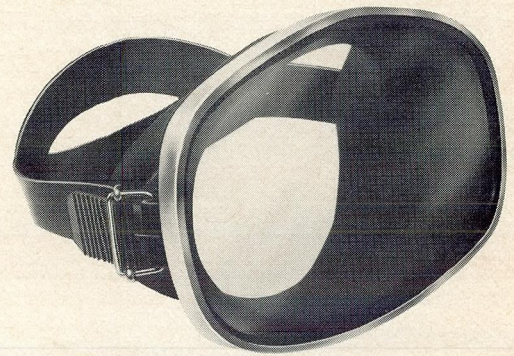
**SEAVIEW "CLEAR-EASE" COMPETITION**

catalog no. 1230  
color **black**  
price **\$10.95**

**PINOCCHIO PROFESSIONAL**

catalog no. 1243  
color **professional black neoprene**  
price **\$8.95**

The exclusive nose design makes the Pinocchio the ultimate in pressure compensating masks. Accepted and used by the world's leading professional and sport divers. Minimum air displacement will allow up to 25% greater skin diving depth. The double feather edge provides a comfortable and absolute, leak-proof seal. The Pinocchio Professional features molded Neoprene for resistance to oil, wear, salt water and the elements—safety glass lens—chrome plated "Lens-Lock" band—split headstrap for secure fit. The Pinocchio "Clear-Ease" incorporates the Cressi non-return valve which provides simple and efficient clearing of the mask.

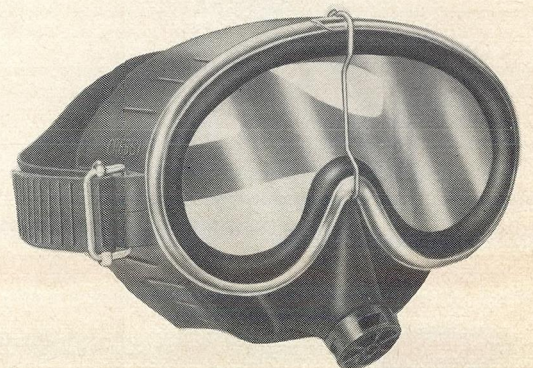
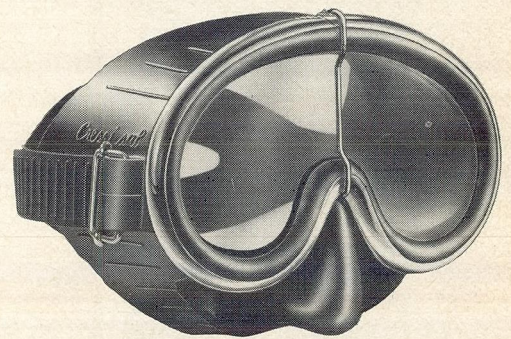
**PINOCCHIO "CLEAR-EASE" PROFESSIONAL**

catalog no. 1244  
color **professional black neoprene**  
price **\$10.95**





## STABILIZATOR

catalog no. **1260**  
 color **professional black**  
 price **\$5.95**

The world's most popular mask incorporates finger wells for pressure compensation of the ears. The Stabilizator Mask features stainless steel "Snap-Lok" band—safety glass lens—split head strap for secure fit—comfortable feather edge seal. The Stabilizator "Clear-Ease" incorporates Healthways simple and efficient non-return valve which allows the diver to clear water from the mask in a normal swimming position.

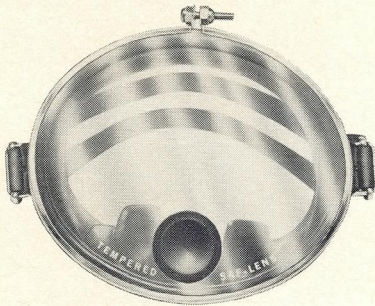

## STABILIZATOR "CLEAR-EASE"

catalog no. **1261**  
 color **professional black**  
 price **\$6.95**

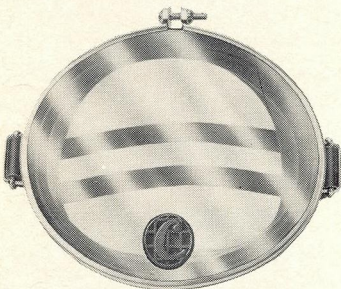

## PANORAMIQUE "CLEAR-EASE"

catalog no. **1224**  
 color **french blue**  
 price **\$5.95**

The exclusive design of the Panoramique "Wide-Angle," the world's most popular mask, brings the lens closer to the eyes at a slant that offers undistorted vision over a wider range. The Panoramique Mask features safety glass lens—stainless steel "Snap-Lok" band—split headstrap for secure fit—comfortable feather edge seal. The Panoramique "Clear-Ease" incorporates the Cressi non-return valve which allows the diver to clear water from the mask in a normal swimming position.



## PANORAMIQUE

catalog no.	<b>1222</b>	<b>1272</b>
color	<b>french blue</b>	<b>professional black</b>
price	<b>\$4.95</b>	<b>\$4.95</b>

## COMPENSATOR

catalog no. **1223**  
 color **french blue**  
 price **\$5.95**

The Compensator mask combines finger wells for pressure compensation of the ears and slanted lens for better vision. Outstanding features: new "Snap-loc" stainless steel band—safety glass lens—split head strap for secure fit—comfortable feather edge seal.





**ESPADON** catalog no. **1220**  
 color **french blue**  
 price **\$4.50**

A high quality, light weight professional mask designed primarily for smaller faces. Outstanding features: new "Snap-Lok" stainless steel band—safety lens—split head strap for secure fit—comfortable feather edge seal.

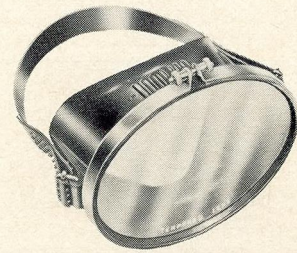

**SQUALE** catalog no. **1225**  
 color **professional black**  
 price **\$4.95**

The Squale Mask is constructed of a special rubber compound for extra softness and durability. Outstanding features: new "Lens-Lock" stainless steel band—safety lens—split head strap for secure fit—comfortable feather edge seal.



**CRESSI STAR** catalog no. **1228**  
 color **blue**  
 price **\$3.25**

A high quality lightweight mask. Outstanding features: stainless steel "Lens-Lock" band—Styrene lens—split headstrap for secure fit—comfortable feather edge seal.

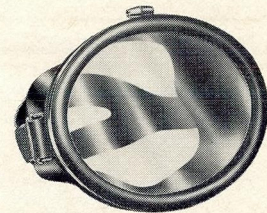

<b>OSTRICA JR.</b> catalog no. <b>1239</b>	<b>OSTRICA BANTAM</b> <b>1240</b>
color <b>blue</b>	color <b>blue</b>
price <b>\$4.25</b>	price <b>\$3.95</b>

The only professionally designed, high quality mask for small faces. Outstanding features: stainless steel "Lens-Lock" band—safety glass lens—split head strap for secure fit—comfortable feather edge seal.



**AQUA CHAMP SENIOR**      **AQUA CHAMP SPECIAL**

catalog no. <b>1202</b>	<b>1201</b>
color <b>blue</b>	color <b>blue</b>
price <b>\$1.95</b>	price <b>\$1.25</b>

These well fitting junior masks are molded of high quality rubber with Healthways exclusive "bend-edge" design and clear Styrene lens.

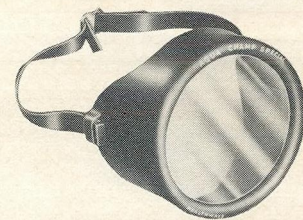

**AQUA PRO GOGGLES**

catalog no. **1107**  
 color **blue**  
 price **\$2.95**

These famous Goggles are designed for maximum safety and feature quality rubber compound—tempered glass lens—feather edge seal.

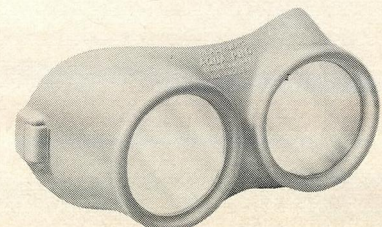



The snorkel, used primarily by skin divers, is also an important safety device to the Scuba diver who surfaces with an empty tank. It enables him to breathe normally during that "long swim back to the boat."

### COMPETITION "CLEAR-EASE"

catalog no. **1436**  
 color **professional black**  
 price **\$3.95**

### COMPETITION

catalog no. **1437**  
 color **professional black**  
 price **\$2.95**

The Balboa snorkel combines the advantage of a flexible snorkel with a truly comfortable "right angle" mouthpiece for less drag. The Balboa "Clear-Ease" incorporates a non-return valve positioned so that annoying residual water is purged with each exhalation.

### GRESSI DELFINO

catalog no. **1430**  
 color **blue**  
 price **\$1.95**

Used by the professional. Made of a one-piece rubber elbow and mouthpiece with a rigid plastic center pipe and an upper section of gum rubber.

### HAITI PROFESSIONAL

catalog no. **1432**  
 color **professional black**  
 price **\$1.95**

The choice of professional in style and construction. Constructed of the finest rubber with a soft, flexible mouthpiece.

### CORONADO

catalog no. **1438**  
 color **professional black**  
 price **\$1.50**

Constructed of a one piece elbow and mouthpiece with a rubber tube.

### SEA SCOUT

catalog no. **1403**  
 color **assorted**  
 price **\$1.00**

A straight professional type snorkel of durable Polyethelene with a soft vinyl mouthpiece.

### SEA DIVE

catalog no. **1405**  
 color **assorted**  
 price **\$1.25**

A popular snorkel with a vinyl mouthpiece and "check-ball" cage.

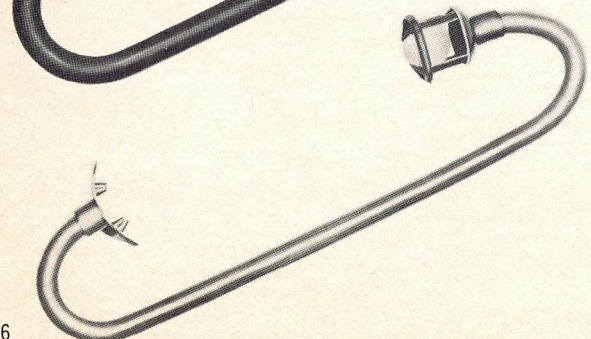
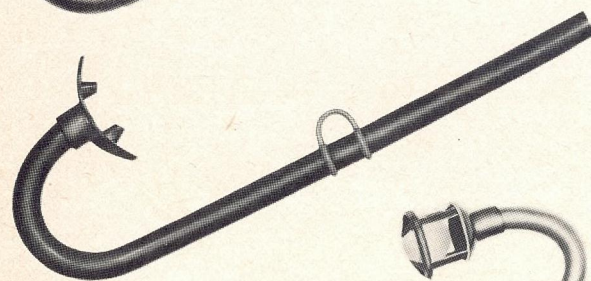
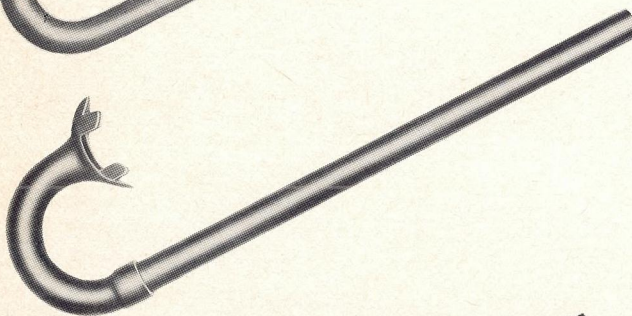
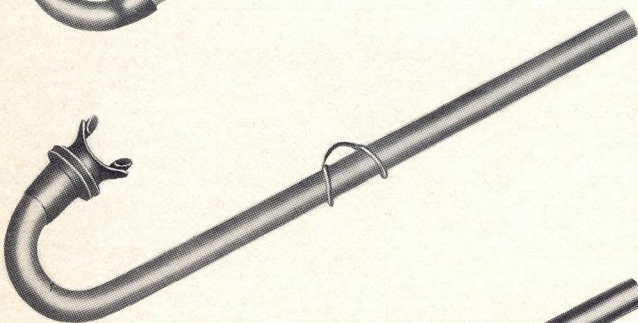
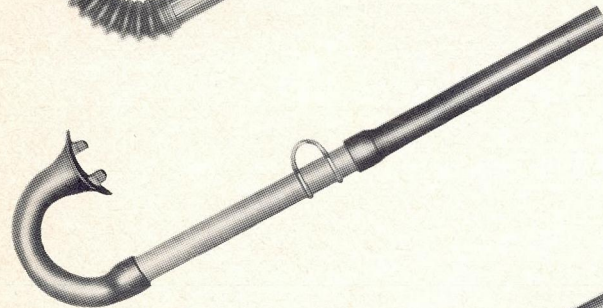
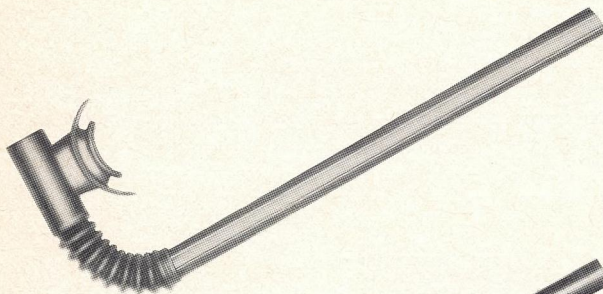





# RONDINE FINS

Why **RONDINE FINS** outsell all others five to one. Created by Cressi, the most renowned manufacturer of underwater sports equipment. The Rondine Fins have achieved worldwide acceptance as the finest in design, construction, fit and performance. The scientifically designed Cressi Rondine is the most copied (but never duplicated) fin in the entire history of underwater sports.

Only the Cressi Rondine offers these outstanding features: Blade angle which provides maximum thrust with minimum effort. The original full foot, open toe design which assures a comfortable fit. The sizes increase in width as well as length in the proper proportions. Light weight—less bulk. Specially integrated rubber compounds assure comfortable fit and efficient blade action.

## COMPETITION

catalog no.	<b>1395</b>	<b>1396</b>	<b>1397</b>	<b>1398</b>
color	<b>black</b>	<b>black</b>	<b>black</b>	<b>black</b>
size	<b>7-9</b>	<b>9-11</b>	<b>11-13</b>	<b>13-16</b>
price	<b>\$13.95</b>	<b>\$13.95</b>	<b>\$13.95</b>	<b>\$13.95</b>

The fin of world champions. Designed for maximum comfort, propulsion and durability. Used by Underwater Demolition Teams throughout the world and by leading professional and sport divers. Made of a combination of rubber textures which provide the famous foot comfort and fin tip rigidity desired by the experienced diver. Now equipped with the Fixe Palme universal strap for absolute fin security under the most turbulent conditions.

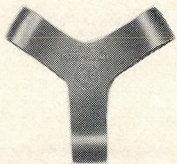

FIXE PALME UNIVERSAL STRAP

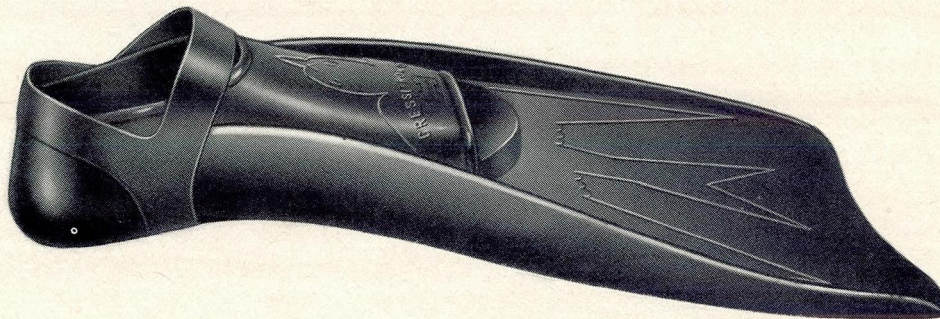

U.S. Patent No. 2737668

## SUPER RONDINE

catalog no.	<b>1390</b>	<b>1391</b>	<b>1392</b>	<b>1393</b>
color	<b>blue</b>	<b>blue</b>	<b>blue</b>	<b>blue</b>
size	<b>5-7</b>	<b>7-9</b>	<b>9-11</b>	<b>11-13</b>
price	<b>\$13.95</b>	<b>\$13.95</b>	<b>\$13.95</b>	<b>\$13.95</b>

The missing link in underwater propulsion—greater propulsion with less effort. From the creator of the world's finest underwater sports equipment comes the all new Super Rondine fin to add a new dimension in underwater propulsion. The Super Rondine fin transforms the usual negative blade area, common to all fins, into a positive thrust area, creating continuous propulsion on the downward as well as the upward thrust. This extra propulsion is obtained by two blade vents covered by a hinged flap, which shuts automatically on the upward thrust and opens on the downward thrust. As a result of this innovation the Super Rondine fin provides increased propulsion with less effort.

HINGED FLAP

BLADE VENT

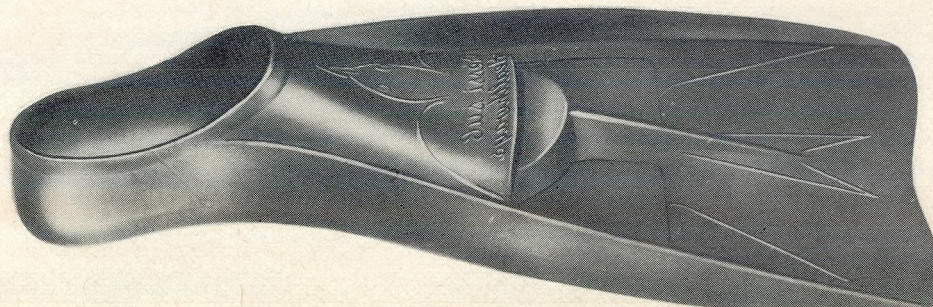
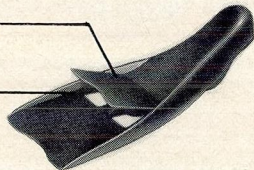

U.S. Patent No. 2737668



# RONDINE FINS



## GENOA PROFESSIONAL

catalog no.	<b>1330</b>	<b>1331</b>	<b>1332</b>	<b>1333</b>	<b>1336</b>
color	<b>black</b>	<b>black</b>	<b>black</b>	<b>black</b>	<b>black</b>
size	<b>5-7</b>	<b>7-9</b>	<b>9-11</b>	<b>11-13</b>	<b>13-16</b>
price	<b>\$10.95</b>	<b>\$10.95</b>	<b>\$10.95</b>	<b>\$10.95</b>	<b>\$10.95</b>

The original black rubber fin that has become a world-wide leader in popularity. The Genoa Professional is designed to provide maximum propulsion from its fin tip and side rigidity and at same time offer form-fitting comfort. Now equipped with the Fixe Palme universal strap for absolute fin security under the most turbulent conditions.



FIXE PALME UNIVERSAL STRAP

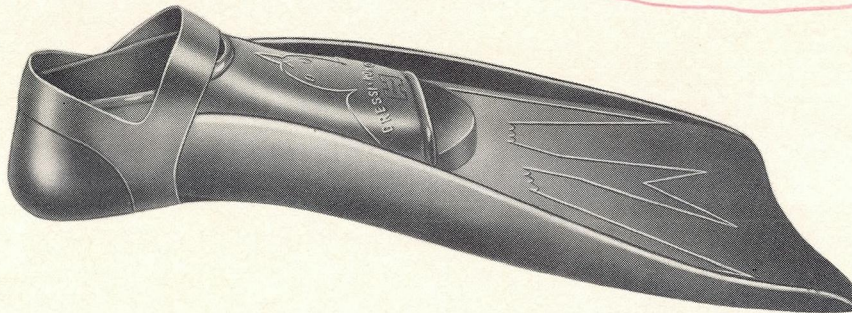

U.S. Patent No. 2737668

## COMORANT

catalog no.	<b>1340</b>	<b>1341</b>	<b>1342</b>	<b>1343</b>
color	<b>black</b>	<b>black</b>	<b>black</b>	<b>black</b>
size	<b>5-7</b>	<b>7-9</b>	<b>9-11</b>	<b>11-13</b>
price	<b>\$9.95</b>	<b>\$9.95</b>	<b>\$9.95</b>	<b>\$9.95</b>

The Rondine Comorant is made of a special black rubber compound that combines a rigid but light weight construction and provides maximum comfort and propulsion.

## MEDITERRANEAN

catalog no.	<b>1350</b>	<b>1351</b>	<b>1352</b>	<b>1353</b>
color	<b>blue</b>	<b>blue</b>	<b>blue</b>	<b>blue</b>
size	<b>5-7</b>	<b>7-9</b>	<b>9-11</b>	<b>11-13</b>
price	<b>\$11.50</b>	<b>\$11.50</b>	<b>\$11.50</b>	<b>\$11.50</b>

Made of floating rubber compound, the Rondine Mediterranean combines the comfort, fin tip rigidity and rugged light weight construction desired by all divers. Will not mark pool.

## GARIBALDI

catalog no.	<b>1360</b>	<b>1361</b>	<b>1362</b>	<b>1363</b>
color	<b>yellow</b>	<b>yellow</b>	<b>yellow</b>	<b>yellow</b>
size	<b>5-7</b>	<b>7-9</b>	<b>9-11</b>	<b>11-13</b>
price	<b>\$12.50</b>	<b>\$12.50</b>	<b>\$12.50</b>	<b>\$12.50</b>

The Rondine Garibaldi is made of a special floating, yellow rubber compound which allows easy identification. It has exceptionally light weight construction, comfort and fin tip rigidity. Will not mark pool.

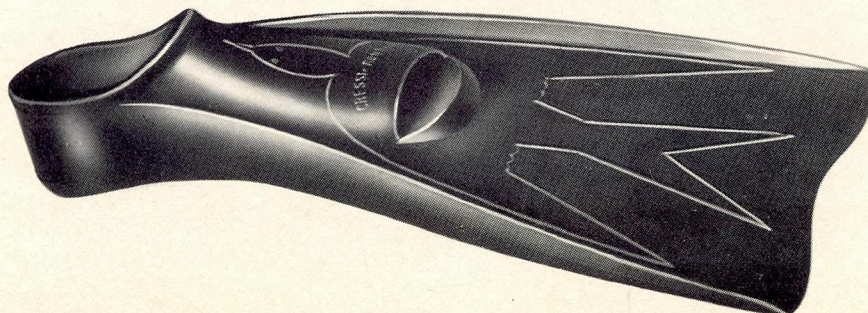

U.S. Patent No. 2737668





# Rondine Fins

## Rondine Junior

catalog no.	1373	1374	1375
color	blue	blue	blue
size	2-3	3-4	4-5
price	\$6.95	\$6.95	\$6.95

The Rondine Junior incorporates all the features of the professional Rondine fins, in sizes to fit young people. These lightweight fins are exceptionally comfortable. Will not mark pool.

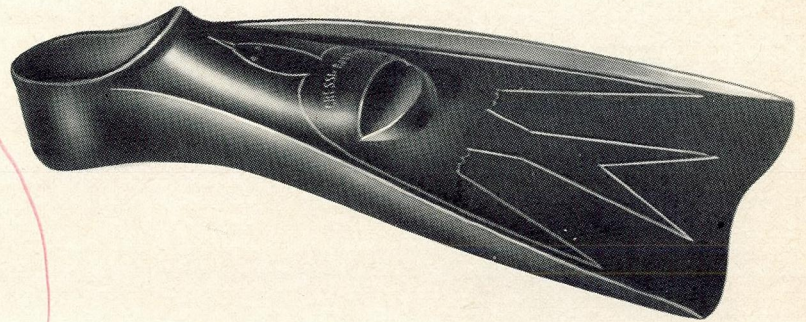

## Water Dogs

catalog no.	1302	1303	1304
color	blue	blue	blue
size	up to 6	4-8	8-13
price	\$4.50	\$4.50	\$4.50

Healthways Water Dogs combine quality and professional design with exceptional durability and lightness. These all-around fins are molded of a special rubber compound and feature an adjustable strap and non-slip safety buckle. Will not mark pool.

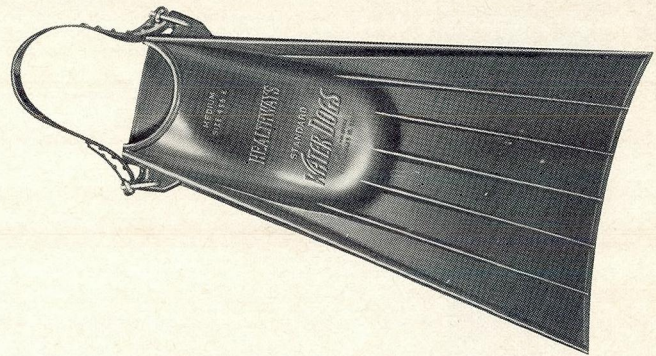

## Fixe Palme

catalog no.	1370	1371
color	black	black
size	7-11 medium	9-16 large
price	\$1.95	\$1.95

The universal Fixe Palme holds any closed heel fin to your foot under the most turbulent conditions. The Fixe Palme provides absolute fin security by holding the fin in three places—instep, arch and heel.

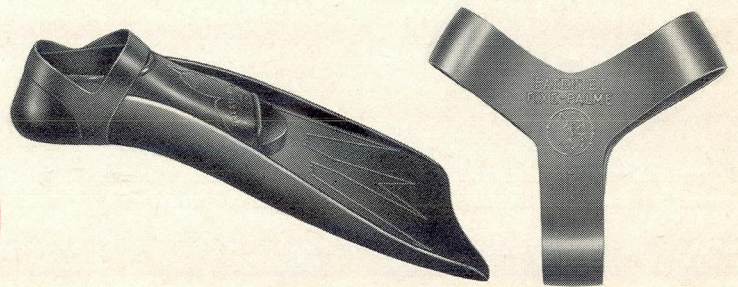

## JR. SKINDIVER SWIM SET

catalog no.	1140	1141	1142
fin size	up to 6	4-8	8-13
price	\$5.95	\$5.95	\$5.95

The perfect skindiving combination for the beginning junior skindiver. Set contains Water Dogs Fins, Aqua Champ Special Mask and Sea Dive Snorkel.

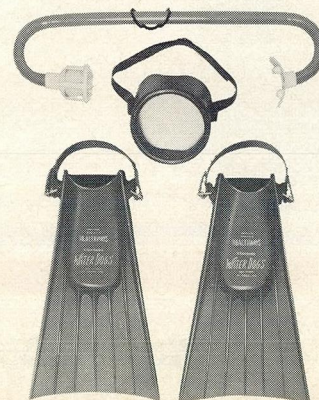



# UNDERWATER EXPOSURE SUITS



## CORONADO CUSTOM NEOPRENE SUIT

2 piece suit made of 3/16" heavy duty, high stretch, double skin foam Neoprene. Features: heavy duty, giant brass zipper • full length crotch strap • double duty snap patch • "Twist Lock" fasteners • high collars for extra protection • cross seam at armpit eliminated.

	catalog no.	<b>0501</b>	<b>0502</b>	<b>0503</b>	<b>0504</b>
3/16"	size	small	medium	M-large	large
	price	<b>\$37.95</b>	<b>\$37.95</b>	<b>\$37.95</b>	<b>\$37.95</b>



## PROFESSIONAL "NYLO-FOAM" NEOPRENE SUIT

2 piece suit made of 3/16" and 1/4" heavy duty, high stretch, foam Neoprene with "four-way stretch" nylon lining for added strength and tear resistance. Features: nylon laminated for permanent bond • heavy duty, giant brass zipper • full length crotch strap • double duty snap patch • "Twist Lock" fasteners • high collars for extra protection • cross seam at armpit eliminated.

	catalog no.	<b>0521</b>	<b>0522</b>	<b>0523</b>	<b>0524</b>
3/16"	size	small	medium	M-large	large
	price	<b>\$42.95</b>	<b>\$42.95</b>	<b>\$42.95</b>	<b>\$42.95</b>

	catalog no.	<b>0526</b>	<b>0527</b>	<b>0528</b>	<b>0529</b>
1/4"	size	small	medium	M-large	large
	price	<b>\$47.50</b>	<b>\$47.50</b>	<b>\$47.50</b>	<b>\$47.50</b>

## COMPETITION DELUXE "NYLO-FOAM" NEOPRENE SUIT

2 piece suit made of 3/16" and 1/4" heavy duty, high stretch, foam Neoprene with "four-way stretch" nylon lining for added strength and tear resistance. Features: nylon laminated for permanent bond • heavy duty brass zippers in arms and legs • heavy duty giant brass zipper in shirt • full length crotch strap • double duty snap patch • "Twist Lock" fasteners • high collars for extra protection • cross seam at armpit eliminated.

	catalog no.	<b>0551</b>	<b>0552</b>	<b>0553</b>	<b>0554</b>
3/16"	size	small	medium	M-large	large
	price	<b>\$45.95</b>	<b>\$45.95</b>	<b>\$45.95</b>	<b>\$45.95</b>

	catalog no.	<b>0556</b>	<b>0557</b>	<b>0558</b>	<b>0559</b>
1/4"	size	small	medium	M-large	large
	price	<b>\$49.95</b>	<b>\$49.95</b>	<b>\$49.95</b>	<b>\$49.95</b>

## BALBOA, AQUAFEMME & CATALINA NEOPRENE JACKETS

An ideal jacket for skin diver, surfer and water skier. Features: 3/16" heavy duty, high stretch, double skin neoprene • heavy duty giant zipper • full length crotch strap on Balboa and Aquafemme Jackets.



	catalog no.	<b>0601</b>	<b>0602</b>	<b>0603</b>	<b>0604</b>
<b>BALBOA</b>	size	small	medium	M-large	large
	price	<b>\$19.95</b>	<b>\$19.95</b>	<b>\$19.95</b>	<b>\$19.95</b>

	catalog no.	<b>0610</b>	<b>0611</b>	<b>0612</b>	<b>0613</b>
<b>AQUAFEMME</b>	size	small	medium	M-large	large
	price	<b>\$19.95</b>	<b>\$19.95</b>	<b>\$19.95</b>	<b>\$19.95</b>

	catalog no.	<b>0950</b>	<b>0951</b>	<b>0952</b>
<b>CATALINA</b>	size	small	medium	large
	price	<b>\$15.95</b>	<b>\$15.95</b>	<b>\$15.95</b>





# SUIT ACCESSORIES

## THERMO-VEST

An important addition to your Neoprene suit for cold water dives. The contoured Thermo-Vest offers a double thickness of protective insulation in the upper body where it is needed most. Made of 1/8" foam neoprene.



catalog no.	<b>0625</b>	<b>0626</b>	<b>0627</b>
size	<b>small</b>	<b>medium</b>	<b>large</b>
price	<b>\$8.95</b>	<b>\$8.95</b>	<b>\$8.95</b>

## "NYLO-FOAM" HOOD

Made of 1/8" heavy duty foam Neoprene with "four way stretch" nylon lining on the inside. The extra long, contour design allows the hood to be worn inside the suit to form a tight seal and eliminate the exchange of water.



catalog no.	<b>0720</b>	<b>0721</b>	<b>0722</b>
size	<b>small</b>	<b>medium</b>	<b>large</b>
price	<b>\$5.80</b>	<b>\$5.80</b>	<b>\$5.80</b>

## "NYLO-FOAM" BOOTS

Made of 1/8" heavy duty foam Neoprene with "four way stretch" nylon lining. The inside lining allows the boots to be put on and removed easily.



catalog no.	<b>0710</b>	<b>0711</b>	<b>0712</b>	<b>0713</b>
shoe size	<b>5-7</b>	<b>7-9</b>	<b>9-11</b>	<b>11-14</b>
price	<b>\$7.95</b>	<b>\$7.95</b>	<b>\$7.95</b>	<b>\$7.95</b>

## GLOVES

Made of 3/16" heavy duty foam Neoprene. They provide maximum mobility and feature a heavy duty zipper for ease in putting on and removing gloves.



catalog no.	<b>0700</b>	<b>0701</b>	<b>0702</b>
size	<b>small</b>	<b>medium</b>	<b>large</b>
price	<b>\$5.95</b>	<b>\$5.95</b>	<b>\$5.95</b>

## RUBBER DUST

catalog no. **1791**  
 description **concentrated powdered hydrous silicate of magnesium**  
 price **\$.65**



## AERO-SPRAY RUBBER DUST

catalog no. **1797**  
 price **\$1.35**

A highly concentrated powdered hydrous silicate of magnesium talc in an easy to use aerosol can. Provides even distribution and covers more area with less powder.



## BLACK MAGIC

catalog no. **1798**  
 description **foam neoprene cement**  
 price **\$1.25**



## DECOMPRESSION TABLE DECAL

catalog no. **1719**  
 price **\$1.00**

DEPTH IN FEET	TIME OF DIVE		DECOMPRESSION TIME AT 10 FEET
	IN MINUTES AND SECONDS	IN MINUTES	
50	78	120	3
60	55	75	2
70	43	60	4
80	35	50	6
90	30	45	6
100	25	40	12
120	18	30	11
140	12	15	4
160	8	15	9
180	5	10	7
200	4	8	25

FOR DEPTH AND TIME EXCEEDING THIS TABLE USE  
HEALTHWAYS' DECOMPRESSION METER

## CORONADO NEOPRENE REPAIR KIT

catalog no. **1794** price **\$2.50**

## MEN'S SIZE CHART

	SMALL	MEDIUM	M-LARGE	LARGE
height	5'4" to 5'7"	5'6" to 5'9"	5'8" to 5'11"	5'10" to 6'2"
weight	120 lbs to 140 lbs	140 lbs to 170 lbs	160 lbs to 190 lbs	180 lbs to 210 lbs

## CORONADO "NYLO-FOAM" REPAIR KIT

catalog no. **1795** price **\$2.50**

## WOMEN'S SIZE CHART

	SMALL	MEDIUM	M-LARGE	LARGE
height	5'0" to 5'3"	5'2" to 5'5"	5'4" to 5'7"	5'6" to 5'9"
bust	to 34"	to 36"	to 38"	to 40"
weight	to 115 lbs	to 130 lbs	to 145 lbs	to 160 lbs



# SCUBAIR SONIC "300"



## WARNS YOU AND YOUR DIVING PARTNERS YOU ARE ON RESERVE AIR.

**FIRST STAGE:** For the first time in the history of self-contained diving, a regulator features an audible alarm device indicating that the air supply in the tank has reached the minimum reserve level of 300 psi. Until all the air has been exhausted, the alarm device continues to operate. With each inhalation, the loud clicking reminds the diver he is breathing reserve air. WITH THE SCUBAIR "300" THERE IS NO POSSIBILITY OF FORGETTING THIS VERY IMPORTANT AND LIFE SAVING FACT. The minimum reserve pressure of 300 psi is approximately the same as in constant air reserve valves, but with the Scubair "300" there is no necessity of manually switching to reserve air. The Scubair "300" first stage features Healthways exclusive internal yoke screw which eliminates the conventional wing nut and provides an easily operated, snag proof means of attaching the regulator—high pressure plug for attaching the Submersible Gauge which enables the diver to know at all times how much air remains in the cylinder while diving—a removable low pressure plug which provides for the attachment of an additional second stage for training purposes. The Scubair "300" first stage is constructed of chrome plated forged brass, stainless steel springs and is impervious to the elements.

**SECOND STAGE:** A "downstream" demand mechanism is engineered into the Scubair "300" second stage to deliver more air than any diving regulator available. This downstream demand valve automatically serves as a safety relief valve in case of an over pressure in the air supply hose. The balanced Venturi system allows the diver to breathe comfortably at any depth with no increase in inhalation effort. The Scubair "300" second stage features double exhaust valves—contoured air exhaust to prevent bubbles from obstructing vision—recessed snag proof clearing button—nylon reinforced Neoprene diaphragm—"Quik-Klip" to facilitate inspection and maintenance—leak proof "O" ring seals for maximum safety—easy turning hose swivel—The Scubair "300" second stage is constructed of heavy gauge chrome plated brass, all stainless steel springs and is impervious to the elements.

## SCUBAIR SONIC "300" COMPLETE

catalog no. 1663  
description single-hose, two-stage regulator  
price \$74.95

U.S. Patent Nos. 195803, 3101732

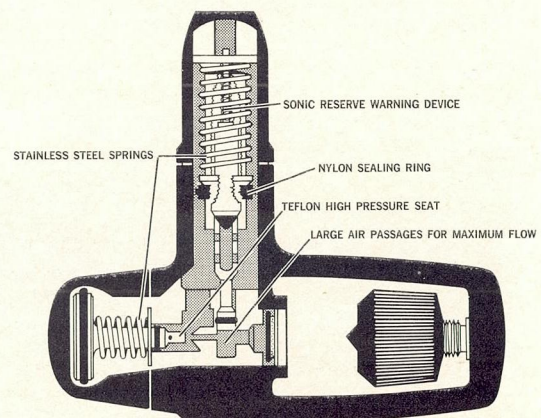

## SCUBAIR SONIC "300" FIRST STAGE ONLY

catalog no. 1663-165  
description incorporates sonic mechanism  
price \$43.50

Attachable to most second stages and will provide the ultimate in diving safety.





# SCUBAIR "J"

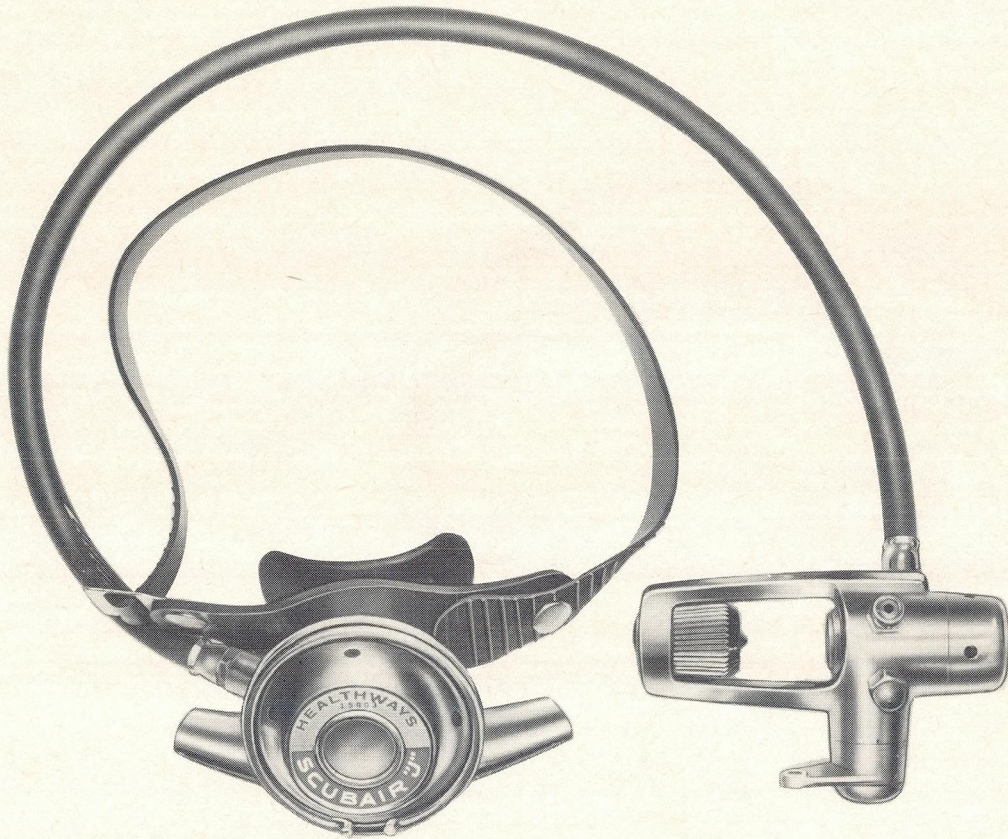

## ELIMINATES EXPENSIVE RESERVE TANK VALVES

**FIRST STAGE:** The Scubair "J" first stage incorporates a spring loaded constant air reserve mechanism. This mechanism provides the diver with a 300 psi constant air reserve even though his cylinders are not equipped with reserve valves. The Scubair "J" first stage features Healthways exclusive internal yoke screw which eliminates the conventional wing nut and provides as easily operated, snag proof means of attaching the regulator—a removable high pressure plug for attaching the Submersible Gauge that enables the diver to know at all times how much air remains in the cylinder while diving—a removable low pressure plug that provides for the attachment of an additional second stage for training purposes. The Scubair "J" first stage is constructed of chrome plated forged brass, all stainless steel springs and is impervious to the elements.

**SECOND STAGE:** A "downstream" demand mechanism is engineered into the Scubair "J" second stage to deliver more air than any diving regulator available. This downstream demand valve automatically serves as a safety relief valve in case of an over pressure in the air supply hose. The balanced Venturi system allows the diver to breathe comfortably at any depth with no increase in inhalation effort. The Scubair "J" second stage features double exhaust valves—contoured air exhaust to prevent bubbles from obstructing the vision—recessed snag proof clearing button—nylon reinforced Neoprene diaphragm—"Quik-Klip" to facilitate inspection and maintenance—leak proof "O" ring seals for maximum safety—easy turning hose swivel—The Scubair second stage is constructed of heavy gauge chrome plated brass, all stainless steel springs and is impervious to the elements.

## SCUBAIR 'J'

catalog no. 1662  
description single-hose, two-stage regulator  
(pull rod included)  
price \$63.95

U.S. Patent Nos. 195803, 3101732

## FIRST STAGE

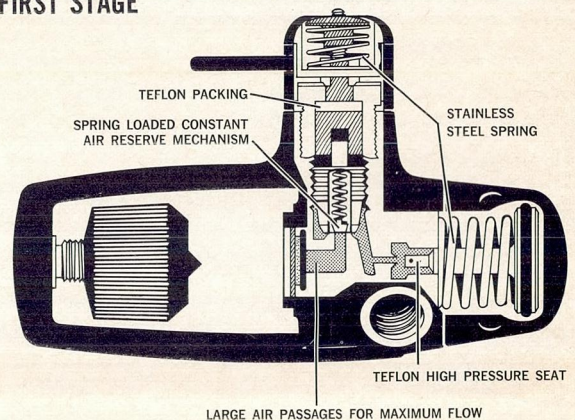



AVAILABLE AUGUST 1965



**FIRST STAGE:** Healthways has redesigned the world famous Scubair regulator to incorporate a balanced valve mechanism that provides the diver with uniform and constant delivery pressure at any tank pressure, and delivers more air to the diver with no increase in effort. The simple piston mechanism incorporates back-up rings that prevent sand, dirt etc. from contaminating the "O" ring seal. A manually operated selector switch enables the diver to adjust his regulator to the depth compensated "Auto Reserve" position or to the "J" Valve" position. Healthways exclusive internal yoke screw eliminates the conventional wing nut and provides snag proof means of attaching the regulator. Finger tip control is all that is necessary. The Scubair +B contains a high pressure plug which can be removed and a Submersible Gauge attached. A removable low pressure plug provides for the attachment of an additional second stage for training purposes. The Scubair +B first stage is chrome plated brass, all stainless steel springs and impervious to the elements.

**SECOND STAGE.** A "downstream" demand mechanism is engineered into the Scubair +B second stage to deliver more air than any diving regulator available. This downstream demand valve automatically serves as a safety relief valve in case of an over pressure in the air supply hose. The balanced Venturi system allows the diver to breathe comfortably at any depth with no increase in inhalation effort. The Scubair +B second stage features double exhaust valves—contoured air exhaust to prevent bubbles from obstructing vision—recessed snag proof clearing button—nylon reinforced Neoprene diaphragm—"Quick-Klip" to facilitate inspection and maintenance—leak proof "O" ring seals for maximum safety—easy turning hose swivel—The Scubair +B second stage is heavy gauge chrome plated brass, all stainless steel springs and impervious to the elements.

**THE ONLY BALANCED REGULATOR TO PROVIDE THE DIVER CONSTANT BREATHING EASE AT ANY TANK PRESSURE AND AT ANY DEPTH.**

## SCUBAIR + B

catalog no. **1666**  
 description **single hose, two stage balanced regulator**  
 price **\$69.95**

U.S. Patent Nos. 195803, 3101732

## FIRST STAGE

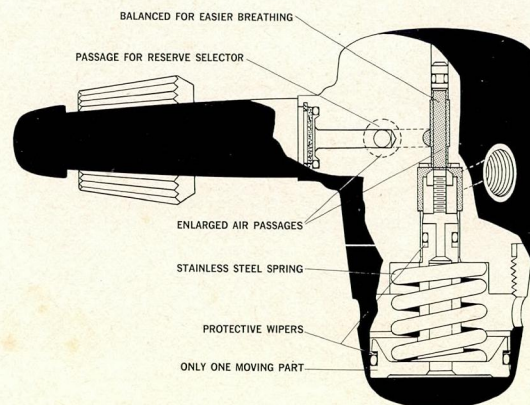



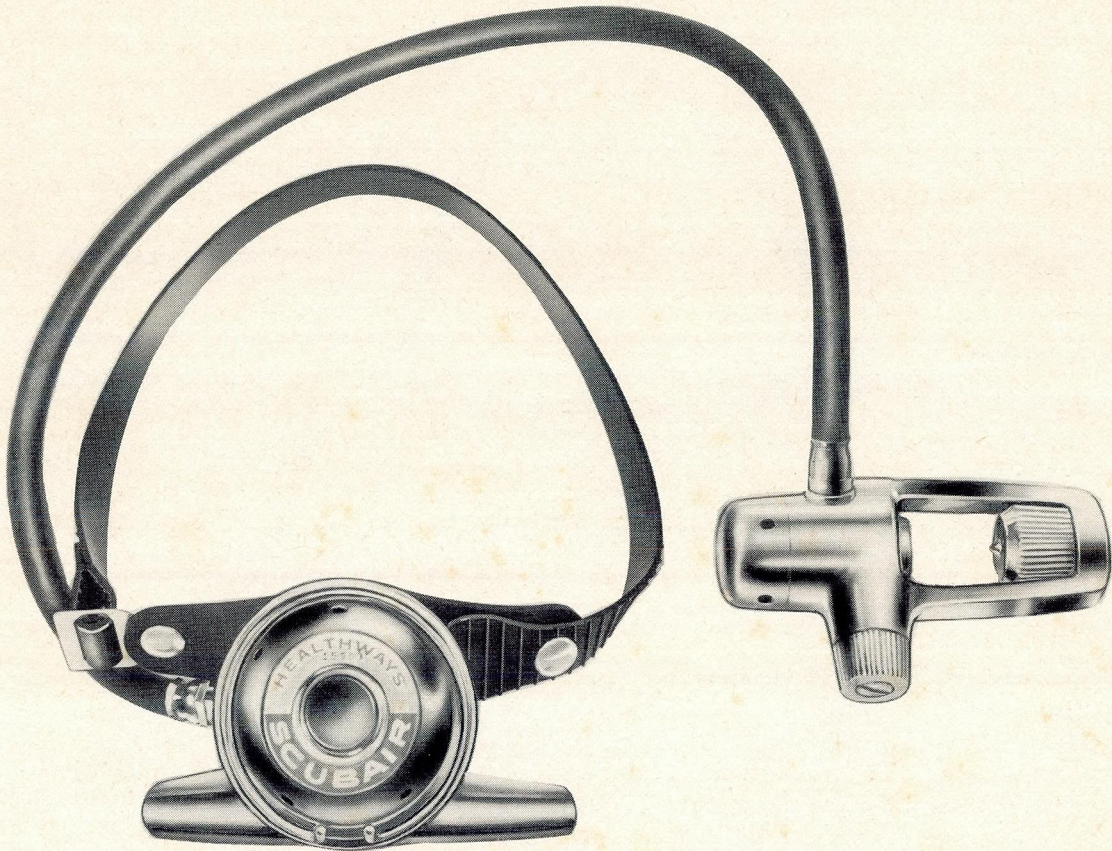

**THE MOST WIDELY ACCLAIMED REGULATOR IN THE HISTORY OF SELF-CONTAINED DIVING. THE REGULATOR THAT ESTABLISHED THE PROFESSIONAL CLASS IN SINGLE HOSE UNITS.**

**FIRST STAGE:** The Scubair first stage has the most efficient and functional design of any single hose regulator. It incorporates the foolproof "O" ring piston pressure reduction mechanism—only one moving part. A manually operated air reserve selector switch enables the diver to adjust his regulator to the automatic depth compensated "Auto Reserve" position or to the "J Valve" position, if the diver prefers to use the constant air reserve valve on his cylinder. Healthways exclusive internal yoke screw eliminates the conventional wing nut and provides an easily operated, snag proof means of attaching the regulator. Finger tip control is all that is necessary for a complete seal with the modern "O" ring valves. The Scubair first stage contains a high pressure plug which can be removed and the Submersible Gauge attached to enable the diver to know at all times how much air remains in the cylinder while diving. A removable low pressure plug provides for the attachment of an additional second stage for training purposes. The Scubair first stage is chrome plated forged brass, all stainless steel springs and impervious to the elements.

**SECOND STAGE:** A "downstream" demand mechanism is engineered into the Scubair second stage to deliver more air than any diving regulator available. This downstream demand valve automatically serves as a safety relief valve in case of an over pressure in the air supply hose. The balanced Venturi system allows the diver to breathe comfortably at any depth with no increase in inhalation effort. The Scubair second stage features double exhaust valves—contoured air exhaust to prevent bubbles from obstructing vision—recessed snag proof clearing button—nylon reinforced Neoprene diaphragm—"Quik-Klip" to facilitate inspection and maintenance—leak proof "O" ring seals for maximum safety—easy turning hose swivel—The Scubair second stage is heavy gauge chrome plated brass, all stainless steel springs and impervious to the elements.

## SCUBAIR

catalog no. **1665**  
 description **single-hose, two-stage regulator**  
 price **\$53.50**

U.S. Patent Nos. 195803, 3101732

## FIRST STAGE

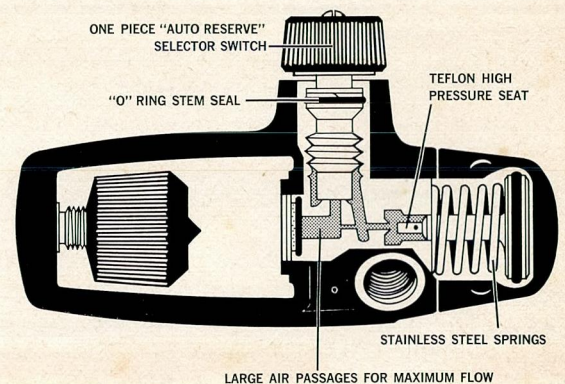



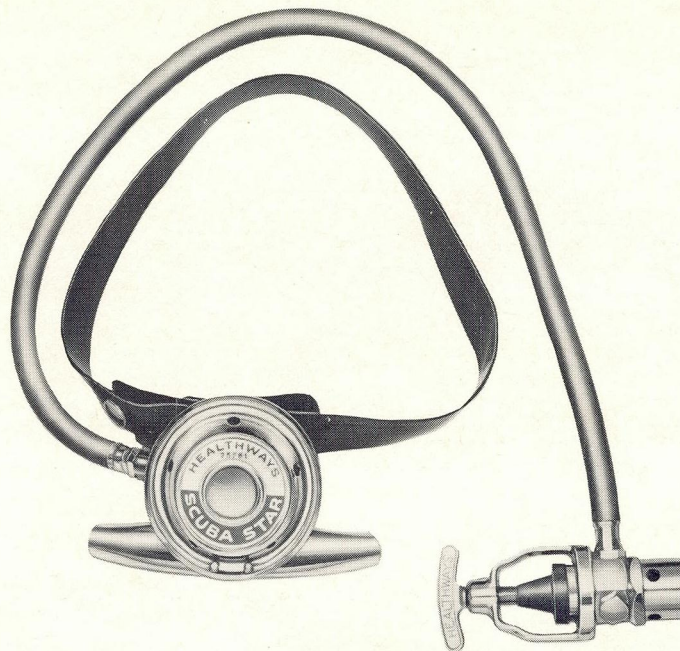

### THE WELL-PROVEN PIONEER OF "O" RING PISTON REGULATORS

The Scuba Star is not limited to "shallow water" or "sport diving," it is professionally designed and engineered to be used comfortably to depths of 200 feet.

**FIRST STAGE:** The Scuba Star first stage has only one moving part which makes it outstanding in function, simplicity and maintenance. A depth compensated automatic air reserve "K Restrictor" is assembled into the high pressure block, which can be replaced with the "J Restrictor" if the diver prefers to use a constant air reserve valve. A safety relief valve is incorporated into the first stage which eliminates the possibility of over pressurizing the regulator. The Scuba Star first stage features a high pressure plug which can be removed and the Submersible Gauge installed to enable the diver to know at all times how much air remains in the cylinder while diving. The first stage is machined from solid brass with a forged yoke and screw, and features a heavy chrome finish.

**SECOND STAGE:** The Scuba Star second stage features Healthways unique double exhaust valves, which assures the diver of an absolute dry air supply under all conditions. The one piece tilt valve demand mechanism provides the diver with easy breathing and offers foolproof simplicity. The Scuba Star second stage features contoured exhaust to prevent bubbles from obstructing vision—"Quik-Klip" to facilitate inspection and maintenance—snag proof clearing button to activate the demand valve—nylon reinforced Neoprene diaphragm with stainless steel diaphragm disc—leak proof "O" ring seals for maximum safety—easy turning hose swivel—high test nylon and Neoprene hose. The Scuba Star second stage is constructed of heavy gauge chrome plated brass, all stainless steel springs, and is impervious to the elements.

### SCUBA STAR

catalog no. 1664  
description single-hose, two-stage regulator  
price \$37.50

### FIRST STAGE

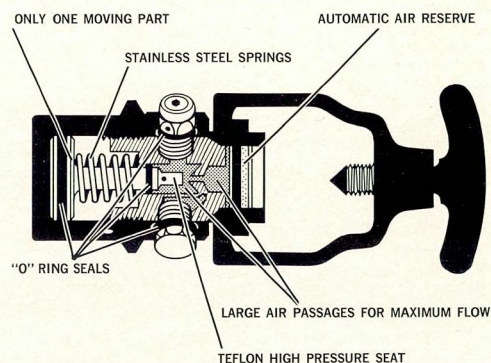

### UNCONDITIONAL TWO YEAR GUARANTEE

TWO YEAR UNCONDITIONAL GUARANTEE FOR ALL HEALTHWAYS REGULATORS. HEALTHWAYS IS THE ONLY MANUFACTURER OF SCUBA EQUIPMENT TO OFFER AN UNCONDITIONAL GUARANTEE AGAINST DEFECTS IN MATERIAL AND WORKMANSHIP FOR TWO YEARS FROM DATE OF PURCHASE.





# SCUBA AND SCUBAMASTER

## SCUBA

catalog no. 1611  
 description double hose, single stage regulator  
 price \$52.95

U.S. Patent Nos. 195803, 3101732

### THE SCUBA IS THE MOST POPULAR AND DEPENDABLE REGULATOR IN ITS CLASS.

The Scuba incorporates a balanced Venturi system which provides the diver with effortless breathing at any depth. A Venturi air

deflector in the mouthpiece prevents involuntary loss of air, common to other single stage Venturi regulators. The Scuba features a simple, efficient, single stage mechanism—pressure balanced exhaust valve for effortless exhalation—a safety non-return mouthpiece—durable Neoprene hose and mouthpiece assembly—Healthways exclusive internal yoke screw which eliminates the conventional wing nut and provides an easily operated snag proof means of attaching the regulator—nylon reinforced Neoprene diaphragm—heavy chrome plated brass and stainless steel construction.

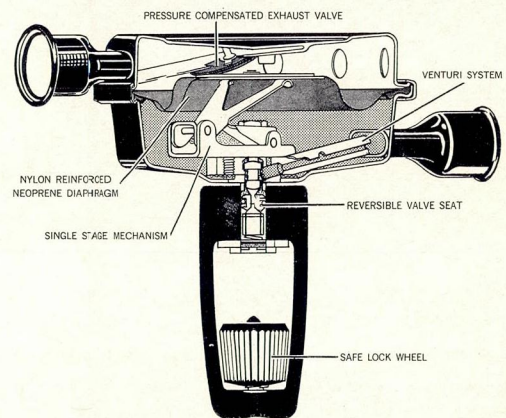
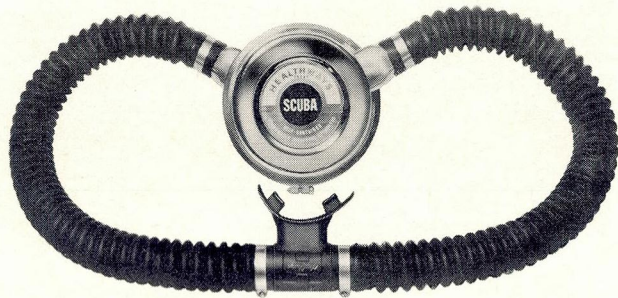

## SCUBAMASTER

catalog no. 1610  
 description double hose, two stage regulator  
 price \$79.95

U.S. Patent Nos. 195803, 3101732

### EXCLUSIVE PISTON DESIGN MAKE THE SCUBAMASTER THE EASIEST BREATHING DOUBLE HOSE REGULATOR AVAILABLE.

The Scubamaster is the only two stage, double hose regulator to incorporate the proven piston first stage design which delivers

more air to the diver with no increase in effort. The built in Venturi system provides comfortable breathing at any depth at no increase in inhalation effort. The Scubamaster is the only double hose regulator that contains a high pressure outlet for installing a submersible tank pressure gauge as well as a low pressure outlet for attaching a single hose second stage for training purposes. The Scubamaster also features: a safety non-return mouthpiece—durable Neoprene hose and mouthpiece assembly—exclusive internal yoke which eliminates the conventional wing nut—nylon reinforced diaphragm—heavy chrome plated brass and stainless steel construction.

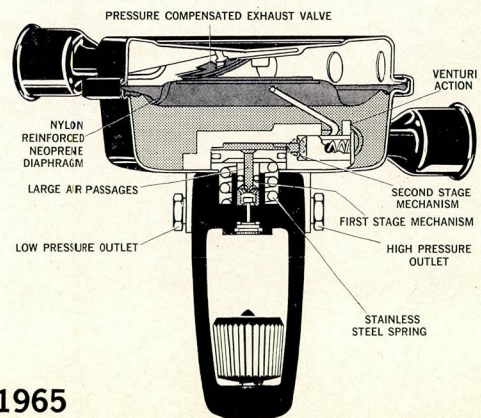
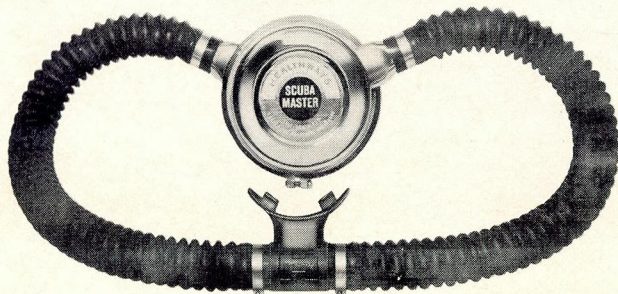

AVAILABLE JUNE 1965



# TANK ASSEMBLIES



## 80 CU. FT. SINGLE TANK ASSEMBLIES COMPETITION MODELS



catalog no. **0210**  
 includes 80 Cu. Ft. Galvanized Tank With  
 3/4" "O" Ring Straight Pipe Thread and  
 No. 1642 High Pressure Valve  
 price **\$66.00**

catalog no. **0211**  
 includes 80 Cu. Ft. Yellow Tank  
 with 3/4" "O" Ring Straight Pipe Thread,  
 No. 1642 High Pressure Valve and No.  
 1448 Tank Boot  
 price **\$66.00**

catalog no. **0200**  
 includes 80 Cu. Ft. Galvanized Tank with 3/4"  
 "O" Ring Straight Pipe Thread and  
 No. 1644 Reserve Valve  
 price **\$80.00**

catalog no. **0201**  
 includes 80 Cu. Ft. Yellow Tank with  
 3/4" "O" Ring Straight Pipe Thread,  
 No. 1644 Reserve Valve and No. 1448  
 Tank Boot  
 price **\$80.00**

## 71.2 CU. FT. SINGLE TANK ASSEMBLIES PROFESSIONAL MODELS



catalog no. **0180**  
 includes 71.2 Cu. Ft. Galvanized Tank with 1/2"  
 Tapered Pipe Thread and No. 1652  
 High Pressure Valve  
 price **\$57.50**

catalog no. **0182**  
 includes 71.2 Cu. Ft. Yellow Tank  
 With 1/2" Tapered Pipe Thread, No. 1652  
 High Pressure Valve and No. 1448  
 Tank Boot  
 price **\$57.50**

catalog no. **0185**  
 includes 71.2 Cu. Ft. Galvanized Tank with 3/4"  
 "O" Ring Straight Pipe Thread and  
 No. 1642 High Pressure Valve  
 price **\$59.00**

catalog no. **0186**  
 includes 71.2 Cu. Ft. Yellow Tank  
 with 3/4" "O" Ring Straight Pipe Thread,  
 No. 1642 High Pressure Valve and No.  
 1448 Tank Boot  
 price **\$59.00**

catalog no. **0190**  
 includes 71.2 Cu. Ft. Galvanized Tank with 1/2"  
 Tapered Pipe Thread and No. 1654  
 Reserve Valve  
 price **\$74.50**

catalog no. **0192**  
 includes 71.2 Cu. Ft. Yellow Tank  
 With 1/2" Tapered Pipe Thread, No. 1654  
 Reserve Valve and No. 1448 Tank Boot  
 price **\$74.50**

catalog no. **0195**  
 includes 71.2 Cu. Ft. Galvanized Tank With 3/4"  
 "O" Ring Straight Pipe Thread and  
 No. 1644 Reserve Valve  
 price **\$76.00**

catalog no. **0196**  
 includes 71.2 Cu. Ft. Yellow Tank  
 With 3/4" "O" Ring Straight Pipe Thread,  
 No. 1644 Reserve Valve and No. 1448  
 Tank Boot  
 price **\$76.00**

## 71.2 CU. FT. DOUBLE TANK ASSEMBLIES PROFESSIONAL MODELS

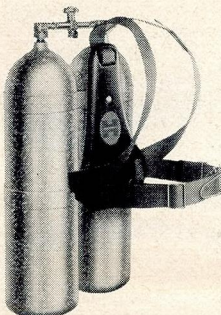

catalog no. **0282**  
 includes 2 Ea. 71.2 Cu. Ft. Galvanized Tanks With  
 1/2" Tapered Pipe Thread, No. 1609  
 High Pressure Valve and No. 1446  
 Contour Scubapak.  
 price **\$143.00**

catalog no. **0284**  
 includes 2 Ea. 71.2 Cu. Ft. Yellow  
 Tanks with 1/2" Tapered Pipe Thread,  
 No. 1609 High Pressure Valve, No. 1446  
 Contour Scubapak and 2 Ea. No. 1448  
 Tank Boots  
 price **\$143.00**

catalog no. **0292**  
 includes 2 Ea. 71.2 Cu. Ft. Galvanized Tanks With  
 1/2" Tapered Pipe Thread, No. 1653  
 Reserve Valve and No. 1446  
 Contour Scubapak  
 price **\$150.00**

catalog no. **0294**  
 includes 2 Ea. 71.2 Cu. Ft. Yellow  
 Tanks With 1/2" Tapered Pipe Thread,  
 No. 1653 Reserve Valve, No. 1446  
 Contour Scubapak and 2 Ea. No. 1448  
 Tank Boots  
 price **\$150.00**





# TANK ASSEMBLIES

## 42 CU. FT. SINGLE TANK ASSEMBLIES

catalog no. 0150  
 includes 42 Cu. Ft. Galvanized Tank and No. 1652 High Pressure Valve  
 price \$47.00

catalog no. 0152  
 includes 42 Cu. Ft. Yellow Tank No. 1652 High Pressure Valve and No. 1448 Tank Boot  
 price \$47.00

catalog no. 0160  
 includes 42 Cu. Ft. Galvanized Tank and No. 1654 Reserve Valve  
 price \$56.50

catalog no. 0162  
 includes 42 Cu. Ft. Yellow Tank, No. 1654 Reserve Valve and No. 1448 Tank Boot  
 price \$56.50

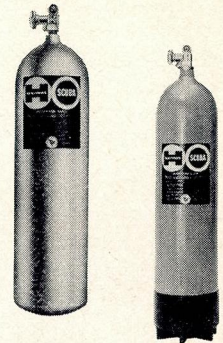

## 42 CU. FT. DOUBLE TANK ASSEMBLIES

catalog no. 0252  
 includes 2 Ea. 42 Cu. Ft. Galvanized Tanks, No. 1609 High Pressure Valve and No. 1446 Countour Scubapak  
 price \$114.00

catalog no. 0253  
 includes 2 Ea. 42 Cu. Ft. Yellow Tanks, No. 1609 High Pressure Valve, No. 1446 Countour Scubapak and 2 Ea. No. 1448 Tank Boots  
 price \$114.00

catalog no. 0262  
 includes 2 Ea. 42 Cu. Ft. Galvanized Tanks, No. 1653 Reserve Valve and No. 1446 Countour Scubapak  
 price \$121.00

catalog no. 0263  
 includes 2 Ea. 42 Cu. Ft. Yellow Tanks, No. 1653 Reserve Valve, No. 1446 Countour Scubapak and 2 Ea. No. 1448 Tank Boots  
 price \$121.00

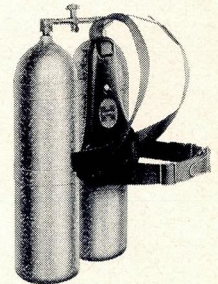

## BARE TANK ASSEMBLIES

catalog no. 0120  
 includes 80 Cu. Ft. Galvanized Tank 2250 P.S.I. Without Valve  
 price \$53.00

catalog no. 0121  
 includes 80 Cu. Ft. Yellow Tank 2250 P.S.I. Without Valve, Includes No. 1448 Tank Boot  
 price \$53.00

catalog no. 0115  
 includes 71.2 Cu. Ft. Galvanized Tank 2250 P.S.I. 3/4" "O" Ring Straight Pipe Thread Without Valve  
 price \$50.00

catalog no. 0116  
 includes 71.2 Cu. Ft. Yellow Tank 2250 P.S.I. 3/4" "O" Ring Straight Pipe Thread, Without Valve, Includes No. 1448 Tank Boot.  
 price \$50.00

catalog no. 0110  
 includes 71.2 Cu. Ft. Galvanized tank 2250 P.S.I. 1/2" Tapered Thread, Without Valve  
 price \$48.50

catalog no. 0112  
 includes 71.2 Cu. Ft. Yellow Tank 2250 P.S.I. 1/2" Tapered Thread, Without Valve, Includes No. 1448 Tank Boot  
 price \$48.50

catalog no. 0100  
 includes 42 Cu. Ft. Galvanized Tank 1880 P.S.I. Without Valve  
 price \$36.50

catalog no. 0102  
 includes 42 Cu. Ft. Yellow Tank 1880 P.S.I. Without Valve, Includes No. 1448 Tank Boot  
 price \$36.50



Healthways professional tanks are made from Alloy Steel as required by I.C.C. (Interstate Commerce Commission) specifications. Healthways uses a Chromiummolybdenum Steel, A.I.S.I. No. 4130, which provides the strength and other physical characteristics required by the I.C.C. There are three tests performed to prove the strength and ductility of the metal. Tensile,

Crush, and Hydrostatic. All cylinders are continually checked to meet Healthways exacting requirements during the production cycle to ensure proper wall thickness, threads, interior and exterior conditions. Healthways new officially approved yellow tanks give the diver added safety factors by providing continuous visual contact with your diving partners.



# SCUBAPAK HARNESSSES



## COMPETITION QUIK-CAM SCUBAPAK

catalog no. **1449**  
 description **single tank harness**  
 price **\$19.95**



The Quik-Cam Scubapak features the first fully adjustable band assembly. Small adjustments are made by the Quik-Cam lever movement, while larger adjustments are made by relocating the Quik-Cam handle. The Quik-Cam band assembly is made of extra heavy 300 series stainless steel and is guaranteed corrosion proof. The single band design provides a more secure tank attachment. The contour of the back plate is designed to eliminate the large gaps found in other types of contour harnesses and features: nylon webbing—easy-to-carry handles—continuous strap arrangement—quick release shoulder strap.

## PROFESSIONAL CONTOUR SCUBAPAK

catalog no. **1445**  
 price **\$18.95**

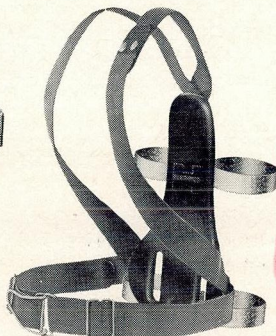

## DOUBLE CONTOUR SCUBAPAK

catalog no. **1446**  
 price **\$24.85**

Healthways Contour Scubapak incorporates all the outstanding features of the famous standard Scubapak—nylon webbing—easy-to-carry handles—continuous strap arrangement and quick release safety buckle. These features are incorporated without adding unnecessary bulk to achieve what a contour pack is designed to do. The Contour Scubapak is designed to eliminate large gaps in the back plate and the result is truly the most comfortable and form fitting contour pack ever developed. The Single Tank Harness features a new stainless steel single band design. This design provides a more secure tank attachment and incorporates an instant action quick release latch that allows removal of the Contour Scubapak in seconds.

## QUICK RELEASE SCUBAPAK

catalog no. **1444**  
 price **\$14.95**

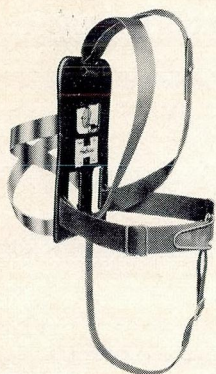

## SCUBAPAK

catalog no. **1443**  
 price **\$13.95**

The Scubapaks are made of aluminum alloy and provides maximum safety, comfort and utility. A protective coating of Vinyl makes the back plate impervious to salt water and the elements. They incorporate two easy-to-carry handles which make carrying the tank as easy as carrying a suitcase. The quick Release Scubapak features an instant action quick release latch and the Standard Scubapak features an easy-action thumb screw for quick assembly and removal of the Scubapak. The ends of the nylon webbing are dipped in rubber compound to prevent fraying. The Scubapaks include the "Jet-O-Sen" Quick release buckle assembly, safety release shoulder strap, and a crotch strap that can be used at the option of the diver.





# PROFESSIONAL TANK VALVES

## HIGH PRESSURE VALVE

catalog no.	1652	1642
description	1/2" tapered pipe thread	3/4" straight pipe thread
price	\$10.95	\$12.95

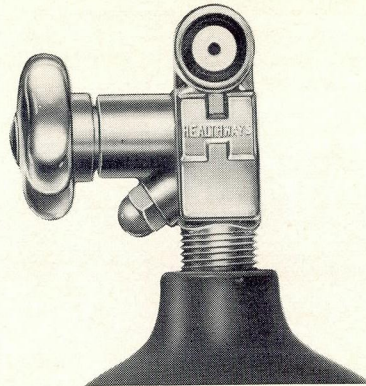

## CONSTANT AIR RESERVE VALVE

catalog no.	1654	1644
description	1/2" tapered pipe thread	3/4" straight pipe thread
includes	pull rod	pull rod
price	\$31.95	\$31.95

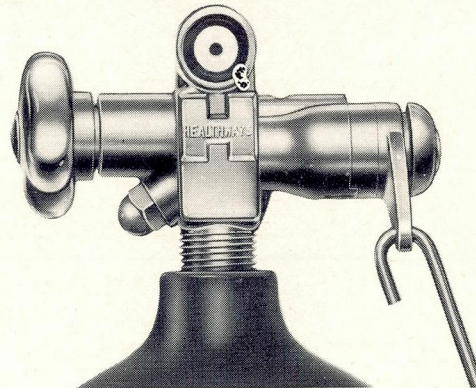

## HIGH PRESSURE VALVE FOR DOUBLE TANK ASSEMBLY

catalog no.	1609
price	\$31.95

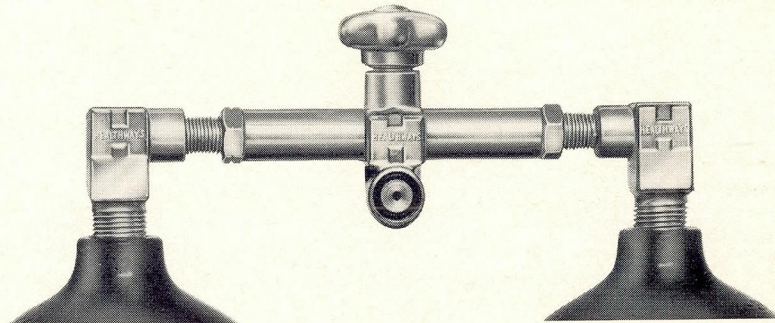

## CONSTANT AIR RESERVE VALVE FOR DOUBLE TANK ASSEMBLY

catalog no.	1653
includes	pull rod
price	\$52.50

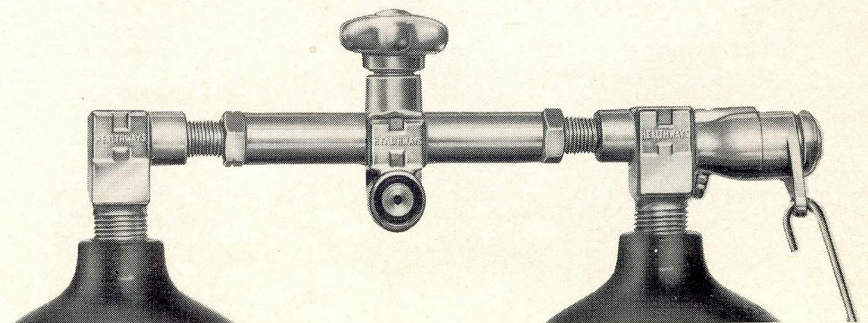





## SUBMERSIBLE STEM GAUGE

catalog no. 1604  
price \$15.95

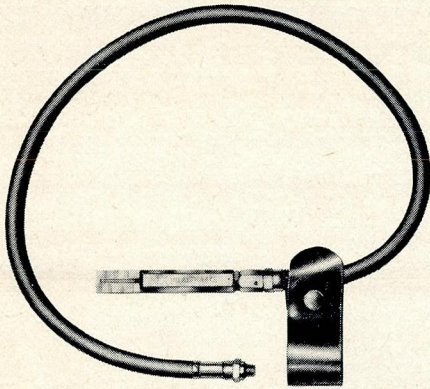

Healthways new Submersible Stem Gauge is designed with the foolproof simplicity and rugged durability required by ardent divers. This accurate, easy-to-read gauge is leak-proof, pressure-proof and unaffected by extremely rough use. It features a flexible HIGH PRESSURE HOSE with STAINLESS STEEL WIRE BRAID, BUNA liner, Neoprene outer covering and heavy chromed brass connections. Attaches to Healthways valves and regulators and enables the diver to know at all times how much air remains in the cylinder while diving.

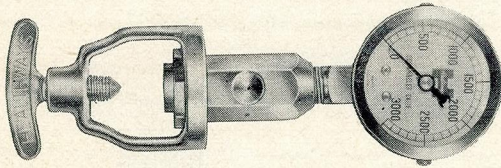

## PRESSURE GAUGE AND YOKE WITH BLEEDER VALVE

catalog no. 1614  
price \$11.95

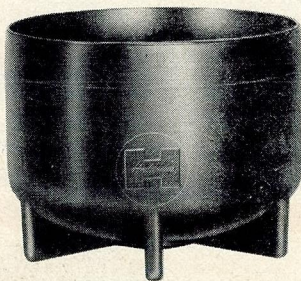

## TANK BOOT

catalog no. 1448  
price \$4.95

A slip-on tank stand to protect boat decks and swimming pools. Made of durable Polyethylene. Boot can be easily removed from cylinder by injecting compressed air or water into small port on bottom.



## CORONADO COMPETITION LEAD WEIGHT BELT

catalog no.	1949	1949-02
description	12 lb. belt complete	2" nylon belt and "quick-klip" buckle only
price	\$16.95	\$4.95

Includes 4 ea. 3 lb. "Big Jim" lead weights and 2" nylon belt with Healthways new "Quick-Klip" safety buckle which allows easy weight and size adjustment.

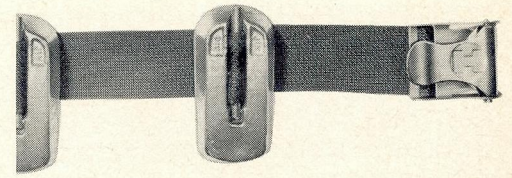

## BALBOA PROFESSIONAL LEAD WEIGHT BELT

catalog no.	1944
description	12 lb. belt complete
price	\$15.95

Includes 4 ea. 3 lb. "sandwich" lead weights and 2" nylon belt with Healthways new "Quick-Klip" safety buckle which allows easy weight and size adjustment.

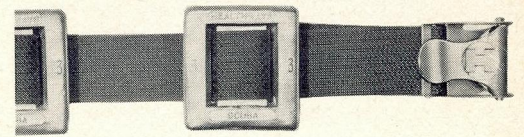

## PROFESSIONAL LEAD WEIGHT BELT

catalog no.	1942	1942-02
description	12 lb. belt complete	2" nylon belt and jet-o-sen buckle
price	\$14.95	\$3.25

Includes 4 ea. 3 lb. "sandwich" lead weights and 2" nylon belt with Healthways Jet-O-Sen quick release safety buckle.

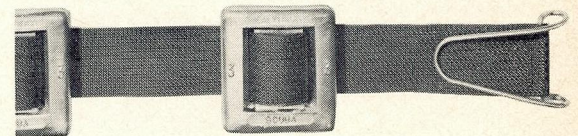

## LEAD WEIGHTS

catalog no.	1901-01	1901-04
description	2 lb. "big jim" lead weight	3 lb. "big jim" lead weight
price	\$2.50	\$3.50
	1943-01	1944-01
	2 lb. "sandwich" lead weight	3 lb. "sandwich" lead weight
	\$2.00	\$3.00

Fits all standard 2" weight belts.

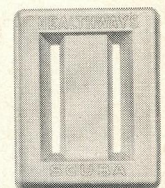
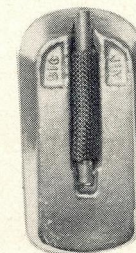

## BUCKLE ASSEMBLIES

catalog no.	1949-04	1942-04
description	"quick-klip" buckle	jet-o-sen buckle assembly
price	\$3.95	\$1.80

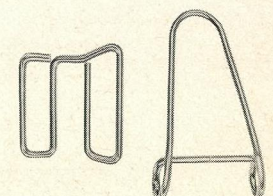
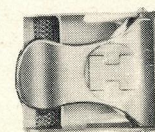



# SPEARFISHING GUNS



Healthways "Competition" spearguns combine all the outstanding features developed through an extensive research and development program designed to give the spearfisherman every possible feature necessary for maximum power, accuracy and durability

- Center-Grip for perfect balance and easy maneuverability
- Spear released from rear of gun utilizing full length of gun to provide maximum power
- Exclusive trigger release leverage system eliminates excess trigger pull regardless of number of power slings

- Slide Ring centers shaft through muzzle for greater accuracy
- Exclusive shaft guides on handle for straightline shooting
- Streamline muzzle design allows easy adding or removal of power slings
- Thumb operated safety allowing "one hand" operation
- Two "Spring-back" line releases positioned to clear all line packs
- Shock Cord
- 1 1/4" diameter aluminum tubing for maximum strength
- Stainless Steel spearshafts and spearheads
- All internal parts are stainless steel

## COMPETITION SUPREME

catalog no. 1540  
shaft length 48", 3/8" diameter  
price \$47.95

AVAILABLE JUNE 1965

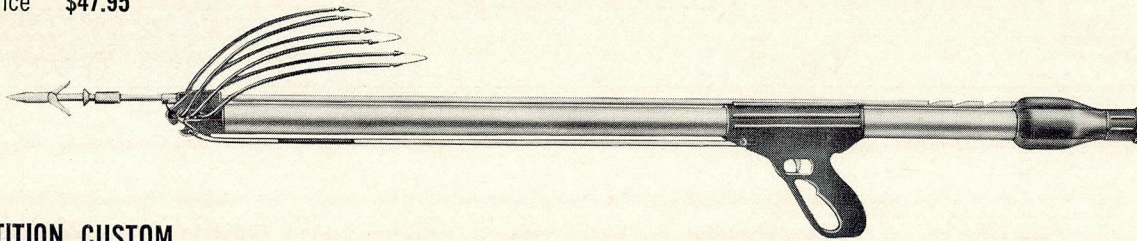

## COMPETITION CUSTOM

catalog no. 1541  
shaft length 36", 5/16" diameter  
price \$34.95

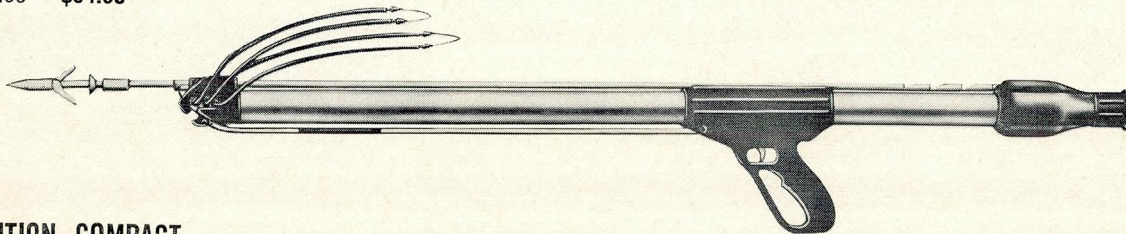

## COMPETITION COMPACT

catalog no. 1542  
shaft length 24", 5/16" diameter  
price \$23.95

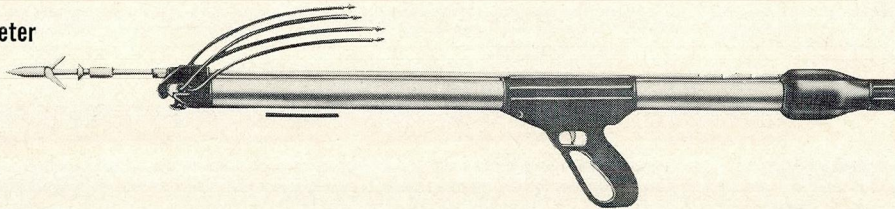

## BALBOA POLE SPEAR

catalog no. 1545  
shaft length 91"  
price \$15.95

A light weight, flexible, tapered fiberglass rod equipped with a stainless steel detachable spearhead. Breaks down to two sections for convenient handling and carrying.

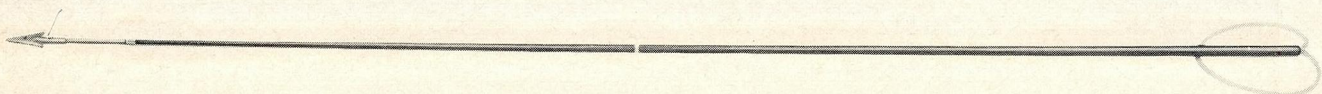



## PROFESSIONAL STANDARD ESPADON

catalog no. 1509  
 shaft length 45½"  
 price \$15.50

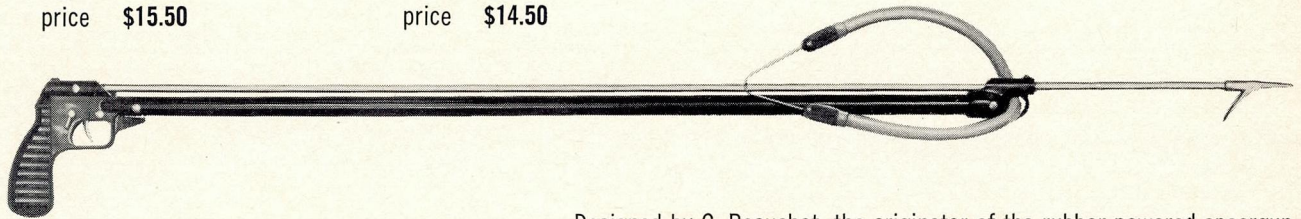

## PROFESSIONAL JR. ESPADON

catalog no. 1508  
 shaft length 41"  
 price \$14.50

## PROFESSIONAL BANTAM ESPADON

catalog no. 1507  
 shaft length 29"  
 price \$11.95

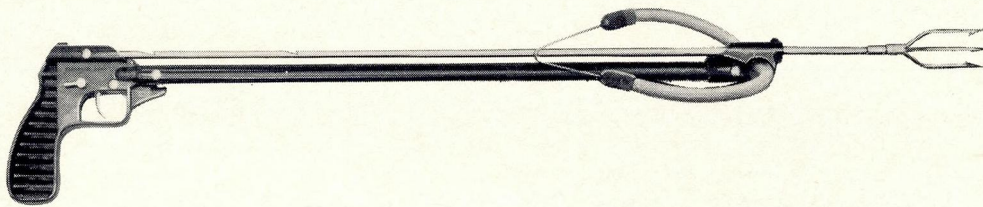

Designed by G. Beauchat, the originator of the rubber powered speargun. Espadon spearguns are dependable all around spear fishing guns. Scientifically designed and balanced to float after release of the spear. They feature improved hand wrapped rubber power slings, tough high impact plastic handles, and a positive safety lever. The Espadons are corrosion and rust resistant.

## PECHE-SPORT DELUXE (Center Grip)

catalog no. 1506  
 shaft length 50"  
 price \$29.95



The original all metal, rust and corrosion resistant rubber powered speargun. Perfectly balanced to be weightless under water, they feature a comfortable pistol grip handle and a positive safety catch, and will float to the surface after the spear has been released.

## CRESSI SAETTA

catalog no. 1531  
 shaft length 30"  
 price \$19.95

## MINI SAETTA

catalog no. 1532  
 shaft length 27"  
 price \$19.95

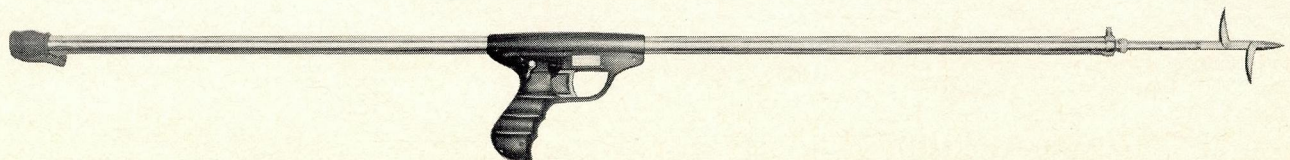

Imported from Italy, Cressi guns are recognized as the finest in quality, accuracy and power. The Saetta is internally spring powered and constructed of non-corrosive materials throughout. The center pistol grip provides perfect balance for exceptional accuracy and maneuverability.



# SPEARHEADS AND ACCESSORIES

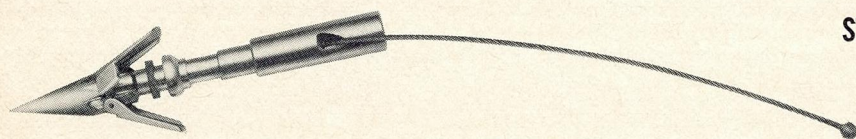

## STAINLESS STEEL DETACHABLE 3-BARB STAR

catalog no. 1500-01  
price \$6.95

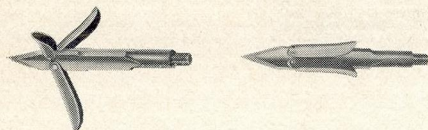

## STAINLESS STEEL 3-BARB STAR

catalog no. 1500-06  
price \$4.25

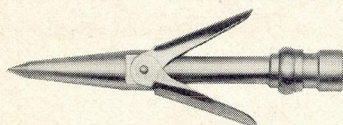

## STAINLESS STEEL 2-BARB

catalog no. 1500-03  
price \$3.95

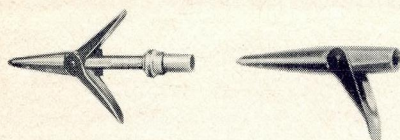

### DOUBLE BARB

catalog no. 1505-02  
price \$2.00

### SINGLE BARB

catalog no. 1504-02  
price \$1.00

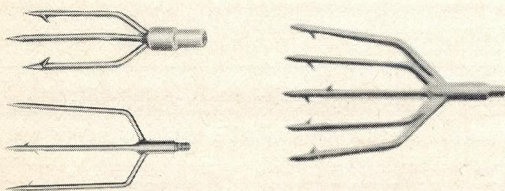

### TRI-POINT

catalog no. 1507-02  
price \$1.75

### THREE PRONG

catalog no. 1500-02  
price \$1.25

### CRESSI FIVE PRONG

catalog no. 1511-02  
price \$1.75



## CRESSI SPEARHEAD ADAPTER SLEEVE

catalog no. 1500-10  
description permits Cressi spearheads to be used on any Peche-Sport or French spear shafts  
price \$.75



## SPEARHEAD ADAPTER

catalog no. 1513-10  
description permits use of all type spearheads  
price \$.75



## NOSE CLIPS (Not for SCUBA diving)

catalog no. 1915  
description made of pure Latex in standard sizes  
price \$.50

## EAR STOPPLES (Not for SCUBA diving)

catalog no. 1928  
description assorted sizes  
price \$.35



## COMPETITION KNIFE AND SHEATH

catalog no. 1993  
price \$10.95

Finally, a divers knife guaranteed not to rust! The Coronado knife blade is made of Series 300 Stainless Steel, with patented "Scalloped" serrations for easy cutting. Sheath design permits attaching to calf of leg.

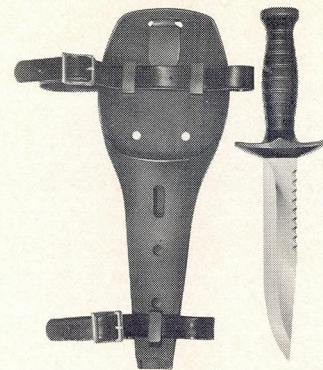

## PROFESSIONAL KNIFE AND SHEATH

catalog no. 1995  
price \$6.50

A compact utility knife, ideal for divers, fisherman, hunters, etc. Made of Series 300 Stainless Steel guaranteed not to rust. Exclusive sheath design allows easy attachment to belt.

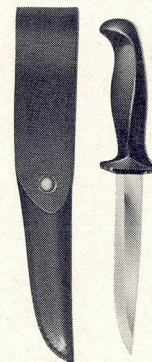

## ESPADON KNIFE AND SHEATH

catalog no. 1955  
price \$7.95

A heavy duty, exceptionally strong, stainless steel knife with an aluminum handle. Sheath design permits attaching to calf of leg.

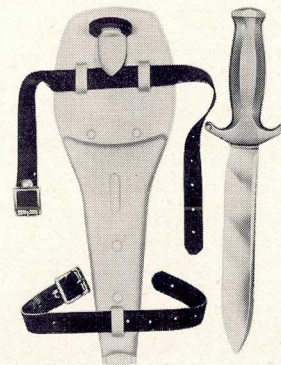

## SCUBALITE

catalog no. 1991  
price \$15.95

The Scubalite with 80,000 candle power is the most powerful diving light ever developed for Scuba divers. The floating, pressure resistant, one piece body is made of high impact Marlex and features a completely water, pressure and corrosion proof switch and an easy to grip handle. The Scubalite may be used successfully to depths of over 200 ft. A simple quarter turn gives the lens a positive seal just as in the deep sea diver's helmet. (Uses 6 standard size "D" batteries, available everywhere.)

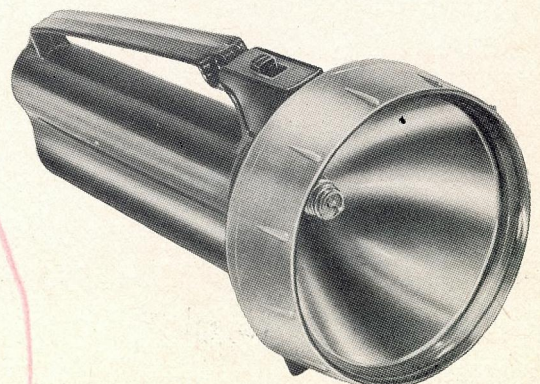



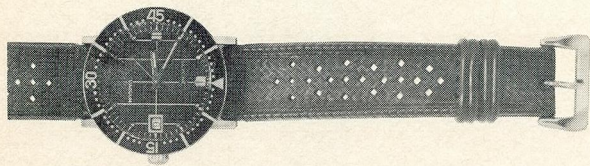

## GLYCINE VACUUM MOBY DICK WATCH

catalog no. **1921**  
price **\$110.00**

The first really water and condensation proof diver's watch. The vacuum seal allows absolutely no condensation, air, dust or water to enter the case and provides unchanging accurate timing. The Moby Dick Watch features surgical stainless steel case, elapsed time bezel, calendar, automatic winding, and 17 jewel movement. Tested to 750 ft. of water. Full one year guarantee.

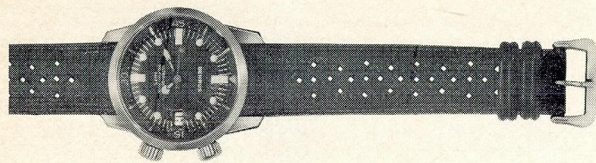

## BENRUS ULTRA DEEP WATCH

catalog no. **1922**  
price **\$92.50**

The only diver's watch backed by an unconditional three year guarantee. The Ultra Deep features stainless steel case, internal elapsed time bezel, calendar, automatic winding and 17 jewel movement. Tested to 660 ft. of water.

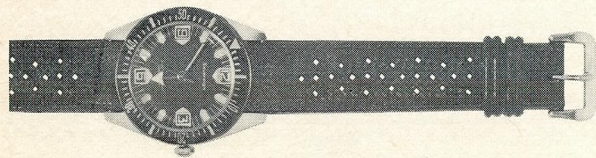

## SOVEREIGN SKIN DIVER WATCH

catalog no. <b>1923</b>	catalog no. <b>1924</b>
description <b>rubber strap</b>	description <b>expansion band</b>
price <b>\$19.95</b>	price <b>\$21.95</b>

A high quality skin diver and swimmers watch with stainless steel case and elapsed time bezel. Full one year guarantee.



## CORONADO 200 FT. DEPTH GAUGE

catalog no. **1960**  
price **\$12.95**

Exclusive form fitting stainless steel case. Mechanism is double sealed for added water tightness. The most fool-proof gauge available.

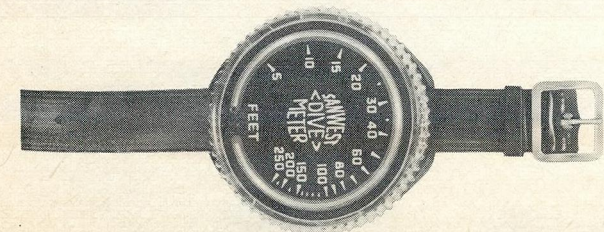

## BALBOA 250 FT. DEPTH GAUGE

catalog no. **1965**  
price **\$5.25**

An accurate, fool-proof depth gauge constructed of unbreakable plastic. No mechanical parts and corrosion problems.





# DIVING SAFETY SECTION

## COMPETITION LIFE JACKET

catalog no. **1982**  
 color **international orange**  
 price **\$23.95**

Designed to Military specifications the Balboa Life Jacket is a deep water vest that assures ascent from great depths, and provides twice the buoyancy to float the diver. Constructed of neoprene impregnated nylon to ensure durability, with a heavy duty brass zipper. It is engineered to float an unconscious or resting diver in a "face-up" position.

The Balboa Life Jacket is inflated by an oversize 16 gram threaded CO<sub>2</sub> cartridge and is easily replaceable. The cartridge puncturing mechanism is located on the reverse side to prevent snagging. It also includes an oral inflation tube that can be used to vent off excess pressure.



## PROFESSIONAL SCUBA-VEST JACKET

catalog no. **1988**  
 price **\$11.95**

The Scuba-Vest is made of specially prepared material that is completely saturated with a special leak proof coating. The Scuba-Vest is engineered to float an unconscious or resting diver in a "face-up" position. One side of the Scuba-Vest is professional black, the other side is officially approved international orange, the most vivid of colors for diving safety.

The Scuba-Vest is inflated by means of a "Squeeze-Grip" detonator containing an oversized cadmium plated CO<sub>2</sub> cartridge. The reusable detonator can be easily removed and a new CO<sub>2</sub> cartridge installed.



## DETONATOR

catalog no. **1988-02**  
 description **for use with No. 1988 Scuba-Vest**  
 price **\$3.00**

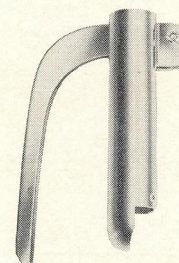

## CO<sub>2</sub> CARTRIDGES

catalog no. **1989**  
 description **to fit no. 1988 Scuba-Vest (pkg of 6)**  
 price **\$3.85**

catalog no. **1982-01**  
 description **to fit no. 1982 Balboa Life Jacket**  
 price **\$.85 ea.**

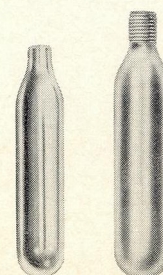





## AUTOMATIC DECOMPRESSION METER

catalog no. **1973**  
price **\$29.95**

This precision instrument functions automatically like an “electronic brain”—continuously memorizing repetitive and multiple depth dives. It records the two essential elements for each dive—TIME and DEPTH, and indicates the necessary decompression time. The Automatic Decompression Meter reproduces the physiology of the body by duplicating the rate at which nitrogen goes into and out of solution in the blood stream. It keeps an exact record of each dive and uses the diving time as well as the surface time to calculate and prescribe the decompression time necessary on the next dive.



## COMPLETE STUDY OF SKINDIVING

catalog no. **1911**  
author **ray hoglund**  
price **\$3.95**

One of the nation's top Skin and SCUBA diving authorities presents a comprehensive and easy to read text on diving. It guides the reader progressively through basic skin diving, SCUBA diving, physics of diving and physiology of diving, mechanics of diving to fundamental safety procedures.

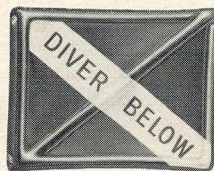

## BIG JIM DIVERS FLAG/BUOY

catalog no. **1981**  
price **\$3.50**

The Big Jim Divers Flag/Buoy combines the conventional divers flag and a new inflatable marker buoy into one compact unit. (Weight not included.)

## INFLATABLE DIVERS FLAG

catalog no. **1969**  
price **\$1.95**

Made of heavy duty vinyl with an inflatable rim that allows it to remain unfurled at all times.

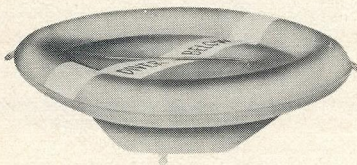

## UTILITY BAG/SAFETY FLOAT

catalog no. **1992**  
price **\$6.95**

Combines an inflatable float, for use as a divers base and a zippered utility bag for storing fish. Made of heavy duty vinyl.



## MARKER BUOY

catalog no. **1987**  
price **\$1.95**

A unique inflatable marker float. It can be used as a safety float in a pool or as a marker for the boating enthusiast or skin diver.



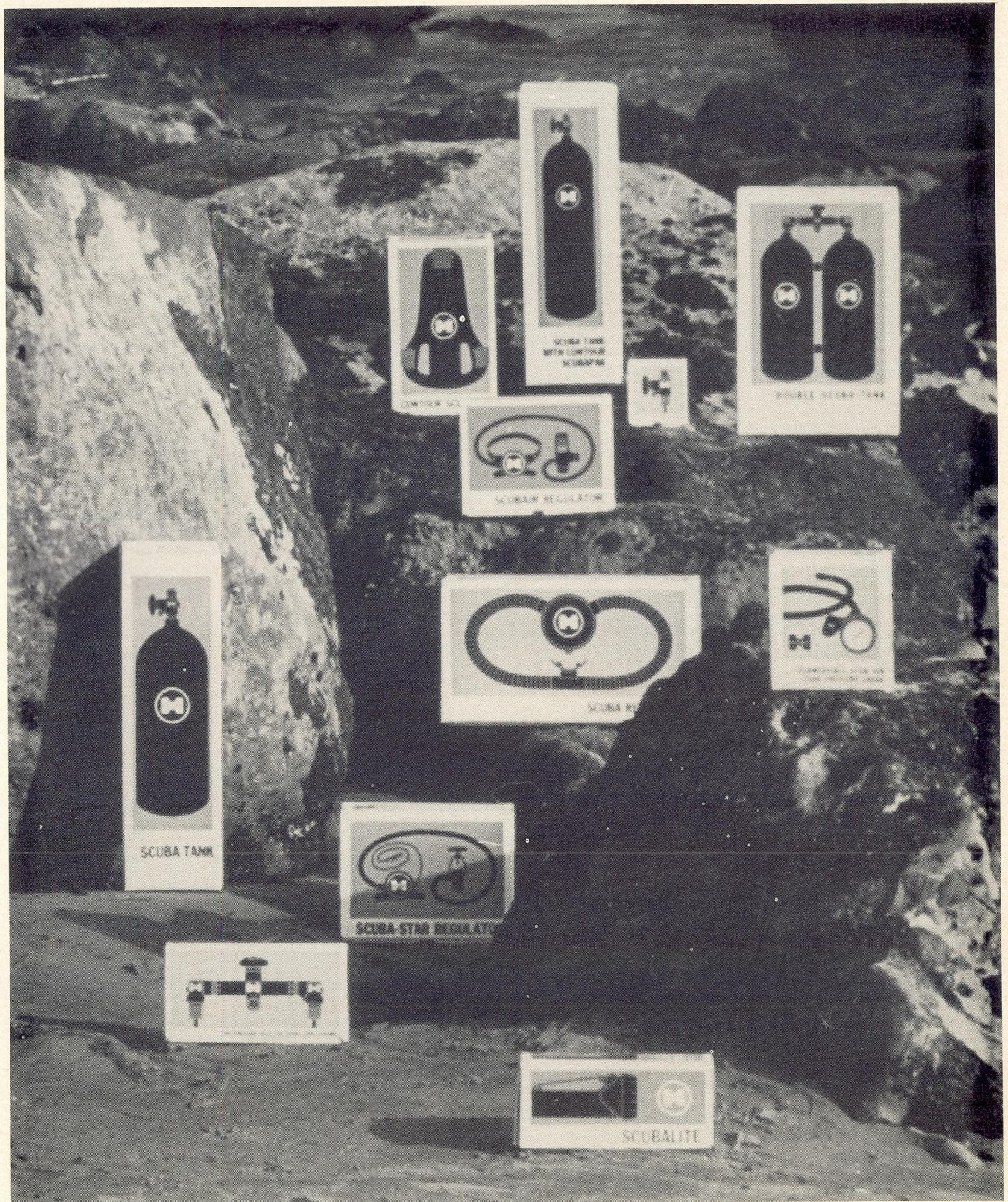

Healthways revolutionary products are presented in sales inviting packages that have won more national awards than any other sporting goods manufacturer. The packages are presented in bold, bright colors which permit instant recognition of contents. They are ideal for the construction of Point of Purchase Displays, window trimming, etc. Healthways also assists you with unparalleled dealer support by national advertising, radio, television, point of purchase and advertising displays.





Main Office & Warehouse: 15500 S. Main Street, Gardena, Calif. 90247/Phone (213) 321-8110  
Mid-Western Warehouse: 531 Webster Street, Chicago, Ill. 60614/Phone (312) EA 7-6725  
Eastern Warehouse: 1029 Atlantic Ave., Brooklyn, N.Y. 11238/Phone (212) ST 9-0965

