

SKIN & SCUBA DIVING, SURFING

EFFECTIVE JUNE 1, 1967

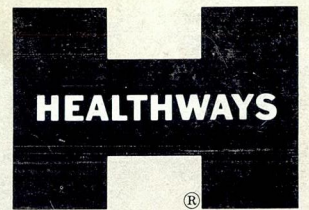

cll



CRESSI RONDINE FINS

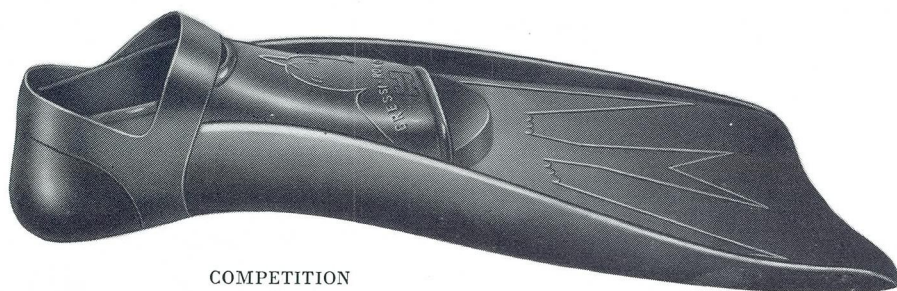

COMPETITION



FIXE PALME SAFETY STRAPS

NEW

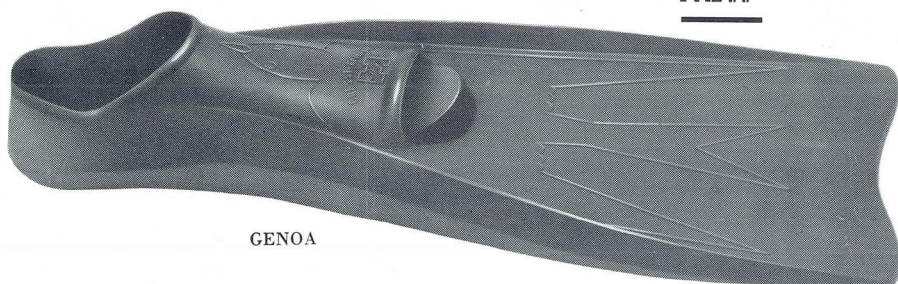

GENOA

NEW



WHY RONDINE FINS OUTSELL ALL OTHERS FIVE TO ONE. Created by Cressi, the Rondine Fins have achieved worldwide acceptance as the finest in design, construction, fit and performance.

Only the Cressi Rondine offers these outstanding features: Blade angle which provides maximum thrust with minimum effort. Original full foot, open toe design which ensures a comfortable fit. Sizes that increase in width as well as length in the proper proportions. Specially integrated rubber compounds for light weight and less bulk and assures a comfortable fit with efficient blade action.

THE COMPETITION

Now molded of a new discovery in natural rubber compounds with the live spring action that assures maximum thrust and power and yet provides the diver with a soft comfortable fit. The Competition Fins are equipped with the Fixe Palme Safety Straps for absolute fin security under the most turbulent conditions.

CAT. NO.	SIZE	COLOR	PRICE
1395	7-9	Black	\$16.50
1396	9-11	Black	\$16.50
1397	11-13	Black	\$17.50
1398	13-16	Black	\$17.50

THE GENOA PROFESSIONAL NEW FLOATING COMPOUND

The Genoa Professional is now made with a new floating rubber compound which provides the extra propulsion that only the highest quality rubber can offer. This new compound provides the fin tip and side rigidity and at the same time offers form-fitting comfort.

CAT. NO.	SIZE	COLOR	PRICE
1330	5-7	Black	\$11.75
1331	7-8½	Black	\$11.75
1332	8½-10	Black	\$11.75
1333	10-12	Black	\$12.50
1336	12-14	Black	\$12.50

FIXE PALME SAFETY STRAPS

The Fixe Palme Safety Straps are designed to hold any closed heel fin to your foot under the most turbulent conditions.

CAT. NO.	SIZE	COLOR	PRICE
1370	7-11	Black	\$2.50
1371	9-16	Black	\$2.50

SOUVENIR PEARL OYSTERS

Imported from the cultured pearl beds of famous Ago Bay, Japan. Guaranteed to contain one pearl or more in the original mother-oyster about three years old. Sealed in a celluloid can containing a special preservative to insure freshness (NON-EDIBLE).

CATALOG NO. 1900 PRICE \$2.50

Pearl Oysters are available in bulk containers for club promotions, "Pearl Dives" etc. Write Healthways for prices and delivery requirements.

CRESSI RONDINE FINN



CRESSI RONDINE FINN

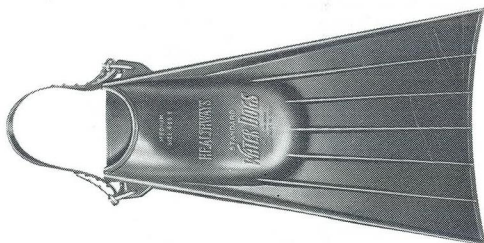

WATER DOG FINN

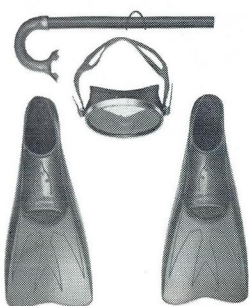

A



B

THE MEDITERRANEAN—FLOATING COMPOUND

The Mediterranean fins are molded of a special light weight compound that allows them to float and yet provides the fin tip rigidity and rugged construction desired by all divers.

CAT. NO.	SIZE	COLOR	PRICE
1350	5-7	Blue	\$11.75
1351	7-9	Blue	\$11.75
1352	9-11	Blue	\$11.75
1353	11-13	Blue	\$11.75

THE CORMORANT

The Cormorant is molded of a black rubber compound that provides rigid but light-weight construction and assures maximum propulsion and foot comfort.

CAT. NO.	SIZE	COLOR	PRICE
1340	5-7	Black	\$9.95
1341	7-9	Black	\$9.95
1342	9-11	Black	\$9.95
1343	11-13	Black	\$9.95

THE CORONADO

The Coronado is molded of a new dark blue rubber compound that provides an exceptionally light weight and comfortable fit with fin tip rigidity for maximum thrust.

CAT. NO.	SIZE	COLOR	PRICE
1320	5-7	Blue	\$8.95
1321	7-9	Blue	\$8.95
1322	9-11	Blue	\$8.95
1323	11-13	Blue	\$8.95

THE RONDINE JUNIOR

The Rondine Junior incorporates all the features of the professional Rondine fins in sizes to fit young children and offer comfortable, light-weight construction.

CAT. NO.	SIZE	COLOR	PRICE
1372	1-2	Blue	\$6.95
1373	2-3	Blue	\$6.95
1374	3-4	Blue	\$6.95
1375	4-5	Blue	\$6.95

THE WATER DOGS

The Water Dogs combine high quality and professional design for maximum durability. They feature a soft rubber compound, adjustable straps and non-slip safety buckles.

CAT. NO.	SIZE	COLOR	PRICE
1302	Up to 6	Blue	\$4.50
1303	4-8	Blue	\$5.50
1304	8-13	Blue	\$5.95

A—CORONADO SWIM SET

A combination swim set consisting of Coronado Fins, Coronado Mask and Coronado Snorkel.

CAT. NO.	FIN SIZE	PRICE
1145	5-7	\$14.95
1146	7-9	\$14.95
1147	9-11	\$14.95

B—JR. SKINDIVER SWIM SET

A perfect combination for the beginning skin diver consisting of Water Dog Fins, Aqua Champ Special Mask and Sea Dive Snorkel. The Aqua Champ Senior Mask is substituted in No. 1142 Set.

CAT. NO.	FIN SIZE	PRICE
1140	Up to 6	\$6.50
1141	4-8	\$6.95
1142	8-13	\$7.50

DIVE MASKS

THE PINOCCHIO

The Pinocchio Masks with their unique nose design provide the diver with the ultimate in pressure compensating masks. The Pinocchio Deluxe "Clear-Ease" combines an all new mask design and larger lens to provide far greater visibility. The minimum air displacement allows up to 25% greater skin diving depth. The Pinocchio Masks also feature safety glass lens and a double feather edge to provide a comfortable and absolute leakproof seal. A new, larger non-return valve is incorporated in the Pinocchio Deluxe "Clear-Ease."

PINOCCHIO SUPER COMPACT (not shown)

CATALOG NO. 1243 COLOR/BLACK PRICE \$9.50

PINOCCHIO DELUXE "CLEAR-EASE"

CATALOG NO. 1244 COLOR/BLACK PRICE \$11.95

THE SEAVIEW COMPETITION

The rectangular shape and slanted lens of the Seaview Competition is designed to provide the maximum in underwater vision. Features include "Snap-Lok" stainless steel band, safety glass lens, neoprene nose pad, feather edge seal and a new flexible head strap for greater comfort. A large non-return valve is incorporated into the Seaview Competition "Clear-Ease."

SEAVIEW COMPETITION

CATALOG NO. 1229 COLOR/BLACK PRICE \$6.95

SEAVIEW COMPETITION "CLEAR-EASE"

CATALOG NO. 1230 COLOR/BLACK PRICE \$8.95

THE STABILIZATOR

The unique finger well design for pressure compensation, super fine feather edge seal and soft comfortable fit has made the Stabilizator one of the nation's leading masks. Features include "Snap-Lok" stainless steel band and safety glass lens. A simple, efficient non-return valve is incorporated in the No. 1261 Stabilizator and an enclosed non-return valve is incorporated in the No. 1262 Stabilizator.

STABILIZATOR

CATALOG NO. 1260 COLOR/BLACK PRICE \$6.25

STABILIZATOR "CLEAR-EASE"

CATALOG NO. 1261 COLOR/BLACK PRICE \$7.25

STABILIZATOR "CLEAR-EASE"

CATALOG NO. 1262 COLOR/BLACK PRICE \$7.50

THE PANORAMIQUE

The slant and wide angle of the Panoramique brings the lens closer to the eyes to allow undistorted vision over a wider range. Features include "Snap-Lok" stainless steel band, safety glass lens and feather edge seal. A recessed non-return valve is incorporated in the Panoramique "Clear-Ease."

PANORAMIQUE

CATALOG NO. 1222 COLOR/BLUE PRICE \$4.95

CATALOG NO. 1272 COLOR/BLACK PRICE \$5.25

PANORAMIQUE "CLEAR-EASE"

CATALOG NO. 1224 COLOR/BLACK PRICE \$5.95

THE COMPENSATOR

The original mask to incorporate finger wells for pressure equalization. Features include "Snap-Lok" stainless steel band, safety glass lens and feather edge seal. A recessed non-return valve is positioned under the nose in the Compensator "Clear-Ease."

COMPENSATOR

CATALOG NO. 1223 COLOR/BLUE PRICE \$5.95

CATALOG NO. 1273 COLOR/BLACK PRICE \$6.25

COMPENSATOR "CLEAR-EASE"

CATALOG NO. 1227 COLOR/BLACK PRICE \$6.95

NEW

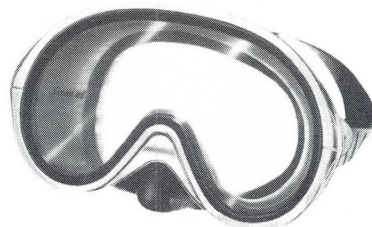

PINOCCHIO DELUXE "CLEAR-EASE" WIDE VISION

NEW IMPROVED



SEAVIEW COMPETITION "CLEAR-EASE"



STABILIZATOR "CLEAR-EASE"

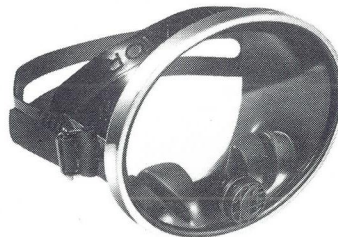

STABILIZATOR "CLEAR-EASE"



PANORAMIQUE "CLEAR-EASE"



COMPENSATOR "CLEAR-EASE"



CORONADO



CRESSI STAR



SQUALE



ESPADON



OSTRICA



AQUA CHAMP



MEDUSA

THE CORONADO

The Coronado is a new light weight professional mask designed for maximum comfort and fit. Features include "Snap-Lok" stainless steel band, safety glass lens and feather edge seal.

CORONADO

CATALOG NO. 1215 COLOR/BLUE PRICE \$3.95

THE CRESSI STAR

A full adult size mask molded of a special soft rubber compound providing perfect fit and comfort. Features include "Lens-Lok" band, clear styrene lens and feather edge seal. Ideal for use in swimming pools.

CRESSI STAR

CATALOG NO. 1228 COLOR/BLUE PRICE \$3.95

THE SQUALE

The Squale is one of the world's most popular masks because of the extra softness and durability provided by a special rubber compound. Features include "Lens-Lok" band, safety glass lens and super fine feather edge seal. An ideal mask for the smaller face diver.

SQUALE

CATALOG NO. 1225 COLOR/BLACK PRICE \$4.95

THE ESPADON

The Espadon is a professional mask of high quality and light weight designed primarily for smaller faces. Features include "Snap-Lok" stainless steel band, safety glass lens and feather edge seal.

ESPADON

CATALOG NO. 1220 COLOR/BLUE PRICE \$4.50

THE OSTRICA

The Ostricas are the only high quality, professionally designed masks available to fit small children. Features include "Lens-Lok" band, safety glass lens and feather edge seal.

OSTRICA JUNIOR

CATALOG NO. 1239 COLOR/BLUE PRICE \$4.25

OSTRICA BANTAM

CATALOG NO. 1240 COLOR/BLUE PRICE \$3.95

THE AQUA CHAMP

Well fitting junior size masks molded of high quality rubber with clear styrene lens.

AQUA CHAMP SENIOR

CATALOG NO. 1202 COLOR/BLUE PRICE \$1.95

AQUA CHAMP SPECIAL

CATALOG NO. 1201 COLOR/BLUE PRICE \$1.50

THE MEDUSA SNORKEL MASK

A full face mask made by Cressi to provide the ultimate in skin-diving enjoyment. The Medusa is molded of a soft rubber compound that assures a super fine feather edge seal. Features include safety glass lens and built in snorkels with double action valves.

MEDUSA SNORKEL MASK

CATALOG NO. 1235 COLOR/BLUE PRICE \$10.95

GOGGLES & SNORKELS

SEA DIVE GOGGLES

A high quality professionally designed goggles with feather edge seal, safety glass lens and steel rims.

SEA DIVE GOGGLES

CATALOG NO. 1109 COLOR/BLACK PRICE \$4.95

AQUA PRO GOGGLES

Designed for maximum comfort and safety featuring safety glass lens and feather edge seal.

AQUA PRO GOGGLES

CATALOG NO. 1107 COLOR/BLACK PRICE \$2.95

SNORKELS

The snorkel, used primarily by skindivers, is also an important safety device to the SCUBA diver who surfaces with an empty cylinder. It enables him to breathe normally during that "long swim back to the boat."

THE COMPETITION

The Competition combines the advantages of a flexible snorkel with a truly comfortable "right angle" mouthpiece for less drag. A recessed non-return valve is incorporated in the Competition "Clear-Ease" so that residual water is purged with each exhalation. The Competition Snorkels are equipped with "Safety-Glo" tops for water safety.

COMPETITION "CLEAR-EASE"

CATALOG NO. 1436 COLOR/BLACK PRICE \$3.95

COMPETITION

CATALOG NO. 1437 COLOR/BLACK PRICE \$2.95

THE HAITI

The choice of the professional in style and construction. Made of a one piece rubber elbow and tube with a soft flexible mouthpiece. The Haiti is equipped with a "Safety Glo" top for water safety.

HAITI

CATALOG NO. 1432 COLOR/BLACK PRICE \$2.10

THE CRESSI DELFINO

Constructed of a one piece rubber elbow and soft mouthpiece with a rigid plastic center pipe and upper section of gum rubber. Now equipped with a "Safety Glo" top for water safety.

CRESSI DELFINO

CATALOG NO. 1430 COLOR/BLACK PRICE \$2.10

THE CORONADO

A professional high quality snorkel constructed of a soft mouthpiece and elbow with a durable rubber tube.

CORONADO

CATALOG NO. 1438 COLOR/BLACK PRICE \$1.95

THE SEA SCOUT

A straight professional type snorkel of durable Polyethylene with a soft vinyl mouthpiece.

SEA SCOUT

CATALOG NO. 1403 COLOR/ASSORTED PRICE \$1.10

THE SEA DIVE

A popular swimmer's snorkel of durable Polyethylene, soft vinyl mouthpiece with "Check Ball" cage.

SEA DIVE

CATALOG NO. 1405 COLOR/ASSORTED PRICE \$1.35



SEA DIVE GOGGLES



AQUA PRO GOGGLES



COMPETITION



HAITI

NEW IMPROVED



CRESSI DELFINO

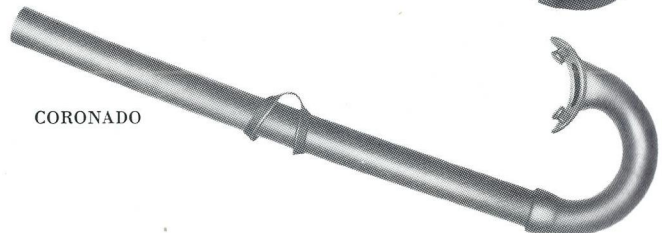

CORONADO

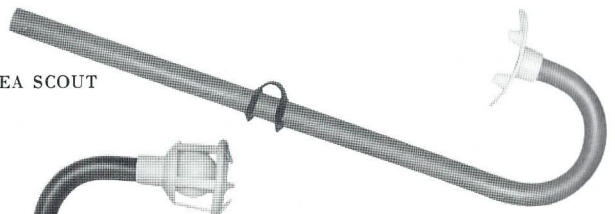

SEA SCOUT



SEA DIVE

SCUBAIR SONIC "300"

HEALTHWAYS



**SAFEST REGULATOR AVAILABLE—
WARNS YOU AND YOUR DIVING
PARTNER YOU ARE BREATHING
RESERVE AIR.**

FIRST STAGE: The Scubair Sonic "300" is the most advanced in engineering and design of any regulator in the diving industry. No other regulator incorporates these outstanding features: Loud, audible alarm device indicating the minimum reserve level of 300 p.s.i. that continues to operate on each inhalation • Fully automatic reserve mechanism eliminates any manual manipulation necessary in "J" type reserves • **WITH THE SCUBAIR "300" THERE IS NO POSSIBILITY OF THE DIVER FORGETTING HE IS BREATHING RESERVE AIR** • Elimination of pull rod assures full tank of air each time cylinder is filled • New straight line design internal yoke screw • High pressure outlet for attaching a submersible pressure gauge • Low Pressure outlet for attaching additional second stage for training purposes • Chromed brass and stainless steel construction.

SECOND STAGE: The Scubair "300" second stage incorporates a "downstream" demand valve mechanism and balanced Venturi system engineered to provide the diver with a maximum air supply at any depth with minimum inhalation effort. The downstream valve mechanism also serves as a safety relief valve in case of an over pressure in the air supply hose. The second stage also features: Double exhaust valves • Contour air exhausts • Recessed purge button • "Quik-Klip" to facilitate inspection and maintenance • Leak proof "O" ring seal • Chromed brass and stainless steel construction.

**SCUBAIR SONIC "300" COMPLETE
CATALOG NO. 1663**

PRICE \$90.00

U.S. Patent Nos. 195803, 3101732

FIRST STAGE

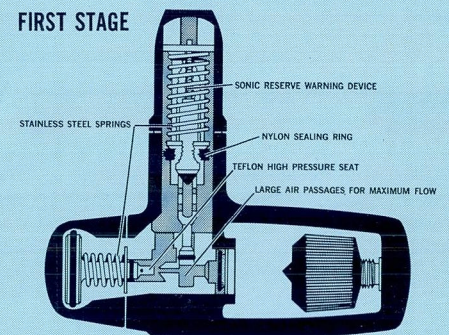



SCUBAIR "J" & SCUBAIR



SCUBAIR "J"

SCUBAIR

SCUBAIR "J" ELIMINATES EXPENSIVE RESERVE TANK VALVES

FIRST STAGE: The Scubair "J" first stage incorporates a spring loaded constant air reserve mechanism providing the diver with a 300 p.s.i. constant air reserve even though his cylinders are not equipped with reserve valves. The first stage also features: New straight line design internal yoke screw • High pressure outlet for attaching a submersible gauge • Low Pressure outlet for attaching additional second stage for training purposes • Chromed brass and stainless steel construction.

FIRST STAGE

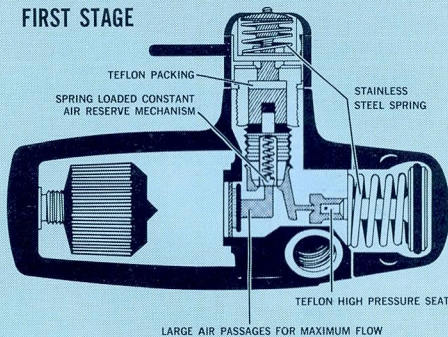

SCUBAIR "J" AND SCUBAIR SECOND STAGE

The Scubair "J" and Scubair second stage incorporates a "downstream" demand valve mechanism and balanced Venturi system engineered to provide the diver with a maximum air supply at any depth with minimum inhalation effort. The downstream valve mechanism also serves as a safety relief valve in case of an over pressure in the air supply hose. The second stage also features: Double exhaust valves • Contour air exhausts • Recessed purge button • "Quik-Klip" to facilitate inspection and maintenance • Leak proof "O" ring seal • Chromed brass and stainless steel construction.

SCUBAIR THE MOST EFFICIENT AND RELIABLE REGULATOR AVAILABLE

FIRST STAGE: The Scubair first stage incorporates a manually operated air reserve selector which enables the diver to adjust his regulator to the automatic depth compensated position ("K" valve) or to the "J" valve position if the divers tank incorporates a constant air reserve valve. The first stage also features: New straight line design internal yoke screw • High pressure outlet for attaching a submersible gauge • Low pressure outlet for attaching an additional second stage for training purposes • Chromed brass and stainless steel construction.

FIRST STAGE

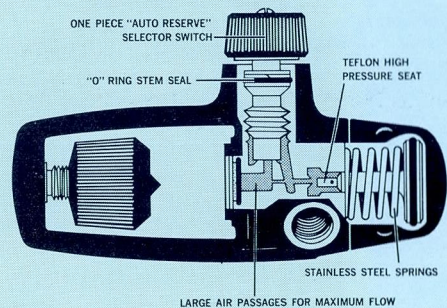

CATALOG NO. 1662 PRICE \$77.50
U.S. Patent Nos. 195803, 3101732

CATALOG NO. 1665 PRICE \$60.00
U.S. Patent Nos. 195803, 3101732

SCUBA STAR TD* & SCUBA

*TOTAL DEMAND



NEW IMPROVED

SCUBA STAR TD

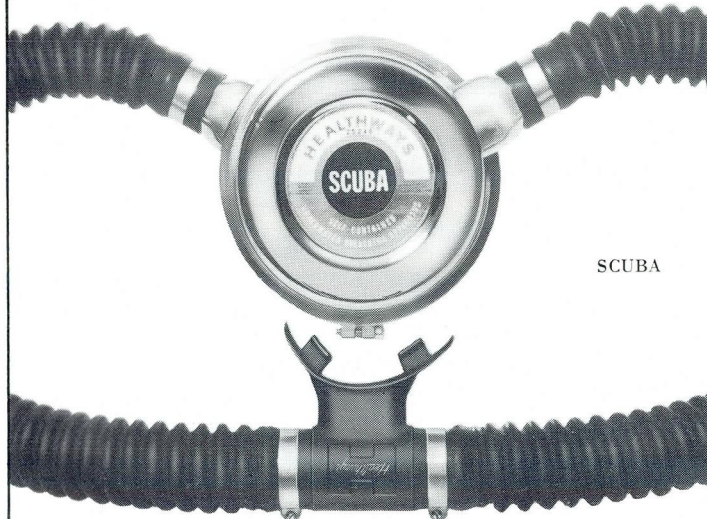

SCUBA

SCUBA STAR TD* NOW TOTAL DEMAND FOR EASIER BREATHING

FIRST STAGE: The Scuba Star TD* first stage, with only one moving part, has proven to be the most outstanding regulator available in function, simplicity and maintenance. The first stage features: A safety relief valve which eliminates the possibility of over pressurizing the regulator • High pressure outlet for attaching a submersible gauge • Chromed brass and stainless steel construction.

SECOND STAGE: Healthways has eliminated the tilt valve mechanism and replaced it with a new "downstream" demand valve and balanced Venturi system to provide the diver with a maximum air supply with minimum inhalation effort. The downstream demand valve also serves as a safety relief valve in case of over pressure in the air supply hose. The second stage also features: Double exhaust valves • Contour air exhausts • Recessed purge button • "Quik-Klip" to facilitate inspection and maintenance • Leak proof "O" ring seal • Chromed brass and stainless steel construction.

SCUBA STAR TD*
CATALOG NO. 1667

PRICE \$47.50

FIRST STAGE

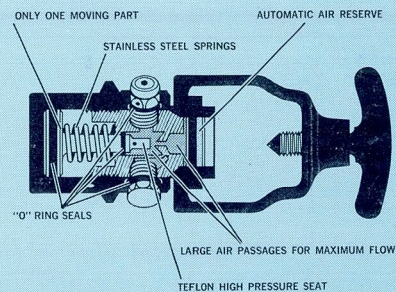

SCUBA THE MOST DEPENDABLE REGULATOR IN ITS CLASS

The Scuba incorporates a balanced Venturi system which provides the diver with effortless breathing at any depth. A Venturi air deflector in the mouthpiece prevents involuntary loss of air common to other single stage regulators. The Scuba also features: A simple single stage mechanism • New straight line design internal yoke screw • Chromed brass and stainless steel construction • Neoprene hose and mouthpiece.

SCUBA
CATALOG NO. 1611

PRICE \$57.50

\$ 37.96

U.S. Patent Nos. 195803, 3101732

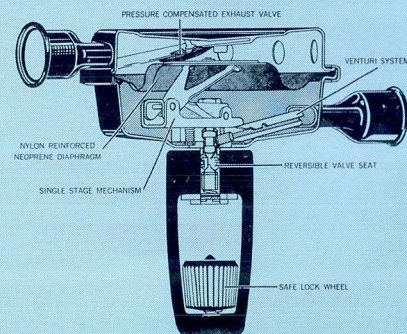



TANK ASSEMBLIES

Healthways' tanks are drawn from Alloy Steel as required by I. C. C. (Interstate Commerce Commission) specifications. Healthways uses a Chromiummolybdenum Steel, A.I.S.I. No. 4130, which provides the strength and other physical characteristics required by the I.C.C. There are three tests performed to prove the strength and ductility of the metal; Tensile, Crush and Hydrostatic. All cylinders are continually checked to meet Healthways exacting requirements to ensure proper wall-

thickness, threads, interior and exterior conditons.

Healthways Safety Yellow tanks are first etched primed to ensure an even bond, then primed again with a Synchrochrome coating for added rust resistance and then a final coat of yellow epoxy for a super fine smooth finish.

All Healthways tanks incorporate 3/4" "O" ring straight pipe threads for easy inspection and maintenance.



80 CU. FT. COMPETITION TANK ASSEMBLIES

CATALOG NO. 0210*

DESCRIPTION 80 CU. FT. GALVANIZED TANK WITH NO. 1642 "K" VALVE

PRICE \$90.00

CATALOG NO. 0211*

DESCRIPTION 80 CU. FT. SAFETY YELLOW TANK WITH NO. 1642 "K" VALVE AND TANK BOOT

PRICE \$90.00

CATALOG NO. 0200*

DESCRIPTION 80 CU. FT. GALVANIZED TANK WITH NO. 1644 "J" VALVE

PRICE \$104.00

CATALOG NO. 0201*

DESCRIPTION 80 CU. FT. SAFETY YELLOW TANK WITH NO. 1644 "J" VALVE AND TANK BOOT

PRICE \$104.00

71.2 CU. FT. PROFESSIONAL SINGLE TANK ASSEMBLIES

CATALOG NO. 0185

DESCRIPTION 71.2 CU. FT. GALVANIZED TANK WITH NO. 1642 "K" VALVE

PRICE \$76.50

CATALOG NO. 0186

DESCRIPTION 71.2 CU. FT. SAFETY YELLOW TANK WITH NO. 1642 K" VALVE AND TANK BOOT

PRICE \$76.50

CATALOG NO. 0195

DESCRIPTION 71.2 CU. FT. GALVANIZED TANK WITH NO. 1644 "J" VALVE

PRICE \$94.00

CATALOG NO. 0196

DESCRIPTION 71.2 CU. FT. SAFETY YELLOW TANK WITH NO. 1644 "J" VALVE AND TANK BOOT

PRICE \$94.00

TWIN 71.2 CU. FT. PROFESSIONAL TANK ASSEMBLIES

CATALOG NO. 0295

DESCRIPTION TWIN 71.2 CU. FT. GALVANIZED TANKS "J" VALVE AND NO. 1446 WITH NO. 1655 TWIN SCUBAPAK

PRICE \$189.00

CATALOG NO. 0296

DESCRIPTION TWIN 71.2 CU. FT. SAFETY YELLOW TANKS WITH NO. 1655 TWIN "J" VALVE, NO. 1446 SCUBAPAK AND TWO TANK BOOTS

PRICE \$189.00

BARE TANKS (not shown)

CATALOG NO. 0115

DESCRIPTION 71.2 CU. FT. GALVANIZED TANK WITHOUT VALVE

PRICE \$61.00

CATALOG NO. 0116

DESCRIPTION 71.2 CU. FT. SAFETY YELLOW TANK WITHOUT VALVE WITH TANK BOOT

PRICE \$61.00

*Sorry, out of stock balance 1967.

New supply available January 1, 1968.

NEW IMPROVED



COMPETITION QUIK-CAM SCUBAPAK



TWIN CONTOUR SCUBAPAK



SCUBAPAK



TANK BOOT

NEW IMPROVED

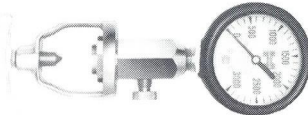

PRESSURE GAUGE WITH BLEEDER VALVE

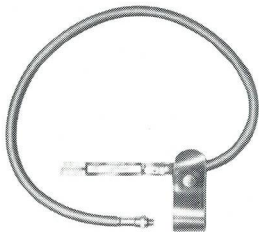

SUBMERSIBLE STEM GAUGE



"K" VALVE

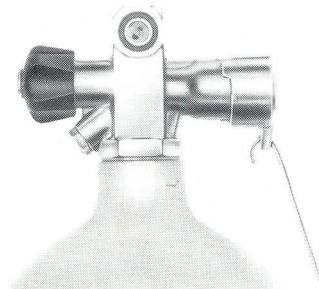

"J" VALVE

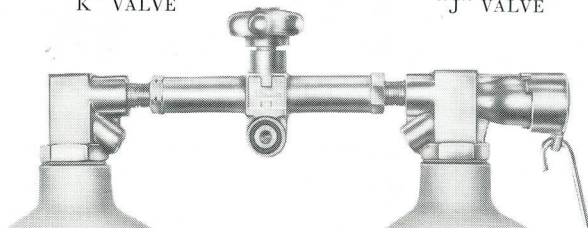

TWIN "J" VALVE

COMPETITION QUIK-CAM SCUBAPAK

A comfortable, form-fitting harness that features: Fully adjustable 300 Series stainless steel band assembly • New cast aluminum cam lever handle with ball lock device to prevent slipping • Continuous nylon cam webbing throughout • Safety release shoulder strap • Competition Quik-Slip buckle.

COMPETITION QUIK-CAM SCUBAPAK
 CATALOG NO. 1449 **\$ 13.81**
 PRICE \$20.00

TWIN CONTOUR SCUBAPAK

A comfortable, form-fitting harness that features: Galvanized twin band assembly • Continuous nylon cam webbing throughout • Safety release shoulder strap • Jet-O-Sen quick release buckle.

TWIN CONTOUR SCUBAPAK
 CATALOG NO. 1446
 PRICE \$26.00

SCUBAPAK

Vinyl coated aluminum harness provides maximum safety, comfort and utility.

SCUBAPAK
 CATALOG NO. 1443
 PRICE \$15.95

TANK BOOT

Polyethylene, slip on tank stand.

TANK BOOT
 CATALOG NO. 1448
 PRICE \$3.95

PRESSURE GAUGE WITH BLEEDER VALVE

Provides the diver with tank air supply before or after diving. New neoprene cover provides shock-proof durability.

PRESSURE GAUGE
 CATALOG NO. 1614
 PRICE \$15.00

SUBMERSIBLE STEM GAUGE

Rugged, fool-proof, easy-to-read gauge attaches to all regulators and valves and enables the diver to know at all times how much air remains in the tank while diving.

SUBMERSIBLE STEM GAUGE
 CATALOG NO. 1604
 PRICE \$14.95

TANK VALVES

HIGH PRESSURE "K" VALVE

CATALOG NO. 1642
 DESCRIPTION 3/4" "O" RING STRAIGHT PIPE THREAD
 PRICE \$19.00

CONSTANT AIR RESERVE "J" VALVE

CATALOG NO. 1644
 DESCRIPTION 3/4" "O" RING STRAIGHT PIPE THREAD
 PRICE \$35.00

TWIN CONSTANT AIR RESERVE "J" VALVE

CATALOG NO. 1655
 DESCRIPTION 3/4" "O" RING STRAIGHT PIPE THREAD
 PRICE \$57.00



SPEARFISHING GUNS

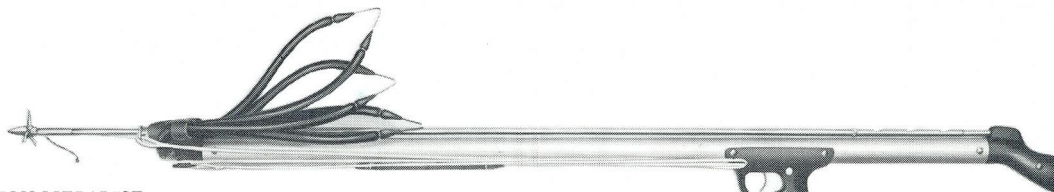

COMPETITION MEDALIST

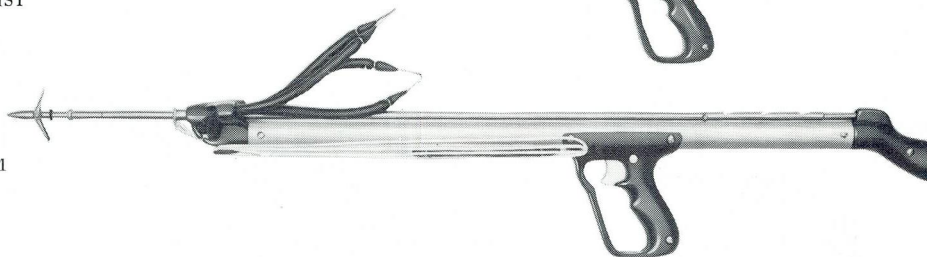

COMPETITION CUSTOM

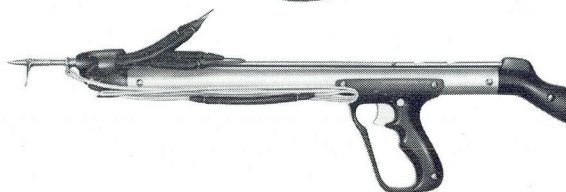

COMPETITION COMPACT

NEW

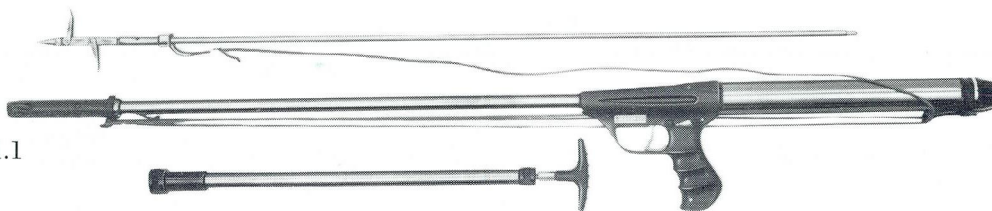

CRESSI MACH 1.1

COMPETITION SPEARGUNS

The Competition Spearguns incorporate many new and unique features which provide the spearfisherman with maximum power, accuracy and dependability. Compare these outstanding features: Contoured center grip handle for balance and easy maneuverability • Rear spear release utilizing full length of gun for maximum power. • Exclusive "pistol grip" butt that allows steady and sure sighting • Trigger release mechanism eliminates excessive trigger pull regardless of number of power slings used • New slide ring design centers shaft through muzzle • Streamline muzzle incorporates unique double sling retainer design to prevent power slings from sliding upward or forward • Thumb operated safety • Side mounted line release • Shock cord • One piece 1 1/4" aluminum tubing • Stainless steel shafts and spearheads • Surgical latex rubber slings • All stainless steel parts throughout.

COMPETITION MEDALIST

48" long, 3/8" shaft with detachable 3 barb spearhead.

CATALOG NO. 1540 PRICE \$45.00

COMPETITION CUSTOM

36" long, 5/16" shaft with 2 barb spearhead.

CATALOG NO. 1541 PRICE \$34.00

COMPETITION COMPACT

24" long, 5/16" shaft with 1 barb spearhead.

CATALOG NO. 1542 PRICE \$30.00

COMPETITION SPEARGUN ACCESSORIES

48" LONG, 3/8" STAINLESS STEEL SHAFT
CATALOG NO. 1540-04 PRICE \$9.95

36" LONG, 3/8" STAINLESS STEEL SHAFT
CATALOG NO. 1541-40 PRICE \$8.95

36" LONG, 5/16" STAINLESS STEEL SHAFT
CATALOG NO. 1541-04 PRICE \$6.50

24" LONG, 5/16" STAINLESS STEEL SHAFT
CATALOG NO. 1542-04 PRICE \$5.50

POWER SLING FOR MEDALIST
CATALOG NO. 1540-08 PRICE \$3.00

POWER SLING FOR CUSTOM
CATALOG NO. 1541-08 PRICE \$3.00

POWER SLING FOR COMPACT
CATALOG NO. 1542-08 PRICE \$2.75

CRESSI MACH 1.1 SPEARGUN

The Mach 1.1 is a lightweight, powerful compressed air speargun designed by Cressi, the pioneer of internally powered spearguns. A unique shaft propulsion and cylinder seal design maintains a constant pressure of 250 p.s.i. to provide the diver with over a years supply of air before recharging. The air cylinder pressure can be increased to 23.5 atmospheres by simply pumping more pressure into the compressed air cylinder. The spearshaft is inserted in the air tight barrel until the trigger is engaged and the Mach 1.1 is then ready for firing.

The Mach 1.1 also features: Positive thumb operated safety • Special shock absorbing propulsion mechanism • Center grip handle and rear counterweight for perfect balance • Variable power pre-set by the diver before entering the water.

CRESSI MACH 1.1 — SHAFT/37"
CATALOG NO. 1550 PRICE \$70.00

SPEARFISHING GUNS

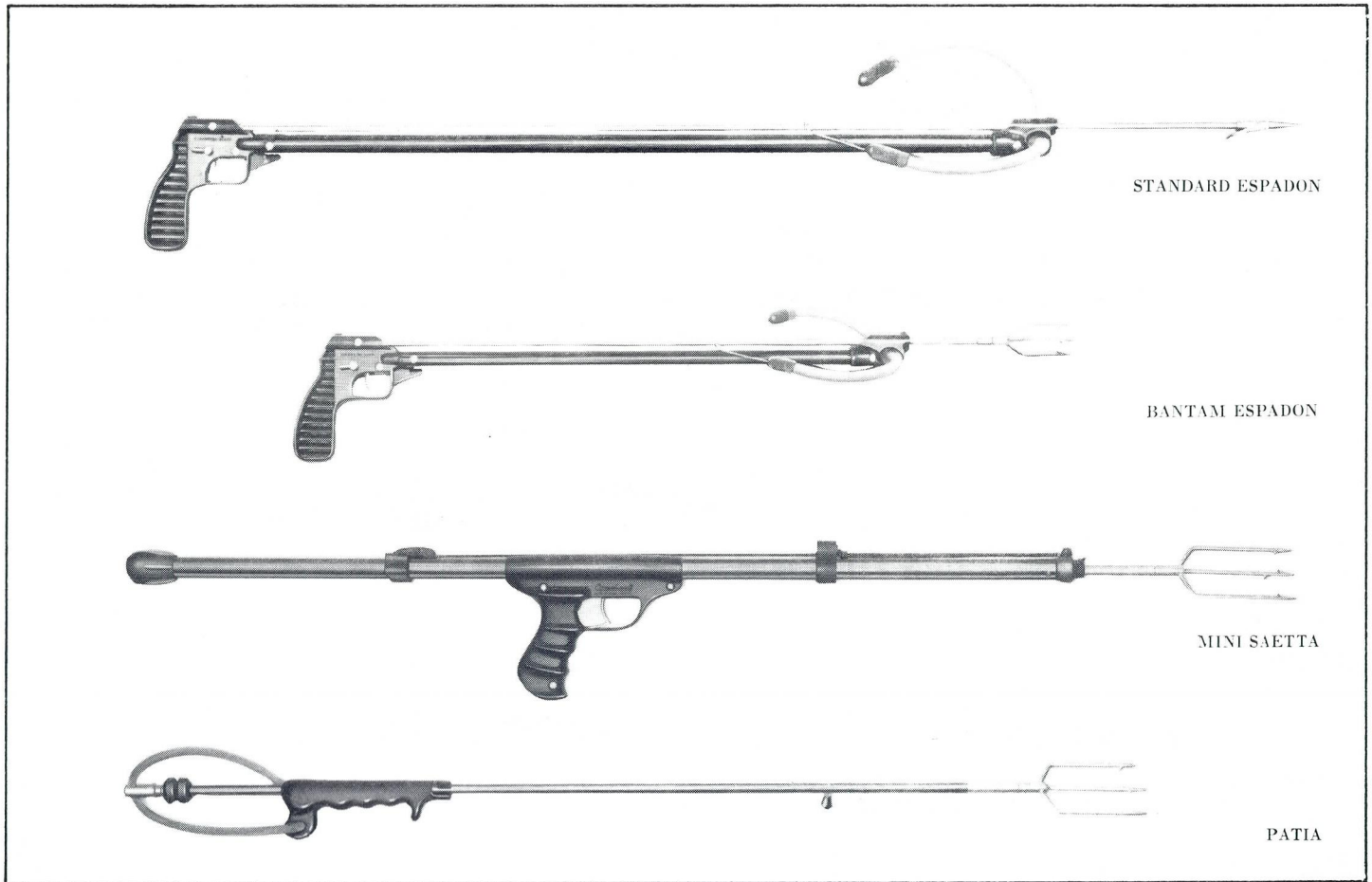

STANDARD ESPADON

BANTAM ESPADON

MINI SAETTA

PATIA

ESPADON SPEARGUNS

Designed by G. Beauchat, the originator of the rubber powered speargun. The Espadon has proven to be a dependable, all around speargun. They feature: A light weight design that allows the speargun to float after shaft is released • Hand wrapped power slings • Tough, high impact plastic handles • Positive safety.

STANDARD ESPADON — SHAFT/45½"
 CATALOG NO. 1509 PRICE \$16.95

JUNIOR ESPADON — SHAFT/41"
 CATALOG NO. 1508 PRICE \$15.95

BANTAM ESPADON — SHAFT/29"
 CATALOG NO. 1507 PRICE \$12.95

MINI SAETTA

Imported from Cressi, the Mini Saetta is recognized as the finest in quality, accuracy and power. The Mini Saetta is internally spring powered which provides more power than most two sling powered spearguns. The contoured center grip provides perfect balance for exceptional accuracy and maneuverability.

MINI SAETTA — SHAFT/27"
 CATALOG NO. 1532 PRICE \$22.00

PATIA HAND SPEAR

A compact hand spear ideal for use in rocky or murky areas. The grip contoured handle features a unique safety latch and surgical rubber power sling.

PATIA HAND SPEAR—LENGTH/40"
 CATALOG NO. 1560 PRICE \$9.95

SPEARHEADS & DIVING ACCESSORIES

- A—STAINLESS STEEL DETACHABLE 3 BARB STAR
CATALOG NO. 1500-01 PRICE \$6.95
- B—STAINLESS STEEL 2 BARB
CATALOG NO. 1500-03 PRICE \$4.50
- C—STAINLESS STEEL 1 BARB
CATALOG NO. 1500-04 PRICE \$2.50
- D—DOUBLE BARB
CATALOG NO. 1505-02 PRICE \$2.00
- E—SINGLE BARB
CATALOG NO. 1504-02 PRICE \$1.00
- F—CRESSI FIVE PRONG
CATALOG NO. 1511-02 PRICE \$2.00
- G—CRESSI THREE PRONG
CATALOG NO. 1500-02 PRICE \$1.25
- H—TRI-POINT
CATALOG NO. 1507-02 PRICE \$1.75
- J—CRESSI SPEARHEAD ADAPTER SLEEVE
Permits Cressi spearheads to be used on any French spear shaft.
CATALOG NO. 1500-10 PRICE \$.75
- K—SPEARHEAD ADAPTER
Permits use of all type spearheads.
CATALOG NO. 1513-10 PRICE \$.75
- L—COMPETITION WEIGHT BELT
Includes 4 each 3 lb. "sandwich" lead weights with 2" nylon belt and "Quik-Slip" safety buckle.
COMPETITION WEIGHT BELT
CATALOG NO. 1944 PRICE \$15.95
COMPETITION WEIGHT BELT & BUCKLE ONLY
CATALOG NO. 1944-02 PRICE \$4.75
- M—PROFESSIONAL WEIGHT BELT
Includes 4 each 3 lb. "sandwich" lead weights with 2" nylon belt and "Jet-O-Sen" safety buckle.
PROFESSIONAL WEIGHT BELT
CATALOG NO. 1942 PRICE \$14.95
PROFESSIONAL WEIGHT BELT & BUCKLE ONLY
CATALOG NO. 1942-02 PRICE \$3.75
- N—SANDWICH LEAD WEIGHTS
Fits all standard 2" weight belts.
3 LB. LEAD WEIGHT CATALOG NO. 1944-01 PRICE \$2.95
2 LB. LEAD WEIGHT CATALOG NO. 1943-01 PRICE \$1.95
- P—BUCKLE ASSEMBLIES
COMPETITION "QUIK-SLIP" BUCKLE
CATALOG NO. 1944-04 PRICE \$2.25
JET-O-SEN SAFETY BUCKLE
CATALOG NO. 1942-04 PRICE \$1.25
- Q—NOSE CLIPS (not for SCUBA diving)
CATALOG NO. 1915 SIZE/STANDARD PRICE \$.50
- R—EAR STOPPLES (not for SCUBA diving)
CATALOG NO. 1928 SIZE/ASSORTED PRICE \$.50

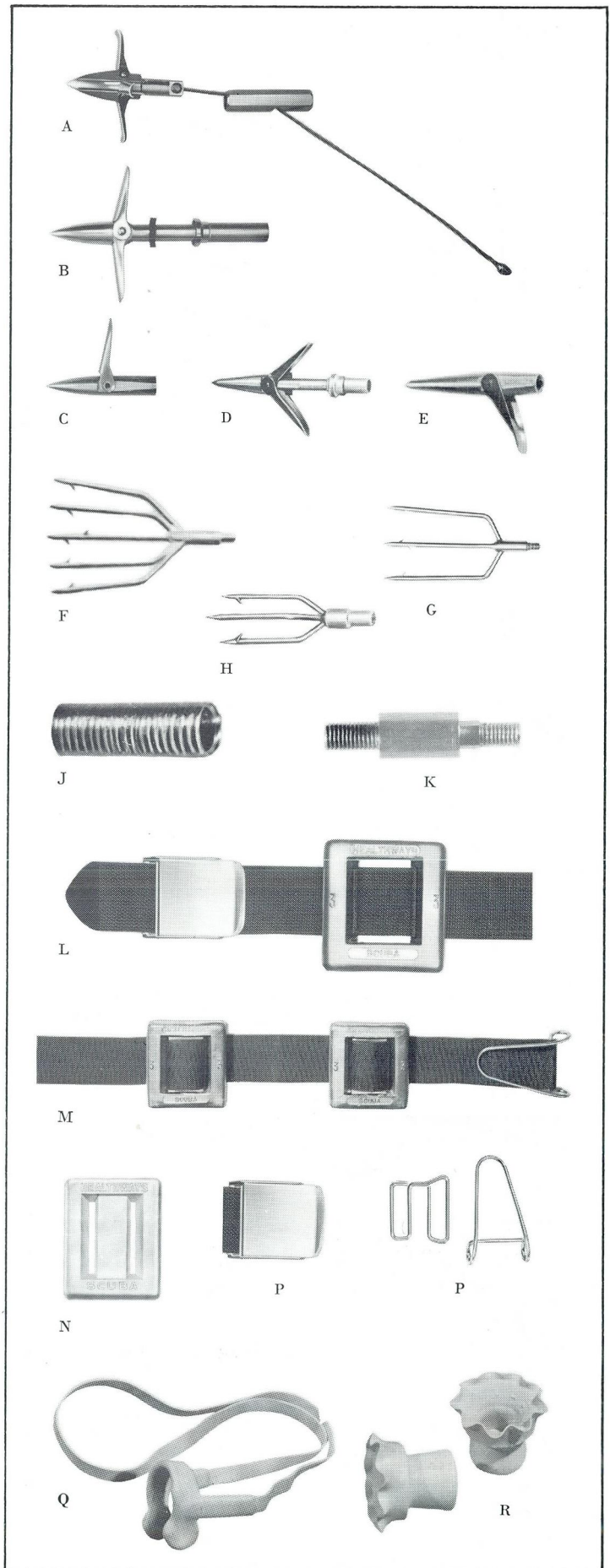

NEW IMPROVED



A



B



C



D

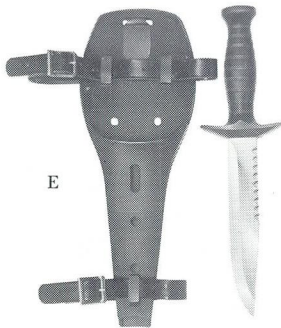

E

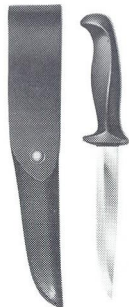

F



G

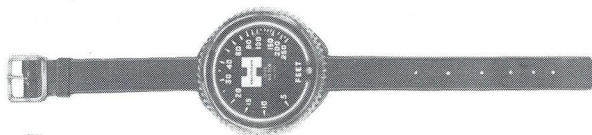

H



J



K



N



L



M

A—COMPETITION LIFE JACKET

Designed to strict Military specifications the Competition Life Jacket is a deep water vest constructed of neoprene impregnated, international orange nylon with a heavy duty brass zipper. The Competition Life Jacket also features utilization of oversize 16 gram CO₂ cartridge, snagproof puncturing mechanism and oral inflation tube to vent off excess pressure, neoprene neck band to prevent chafing.

COMPETITION LIFE JACKET

CATALOG NO. 1982

PRICE \$26.00

B—PROFESSIONAL SCUBA VEST LIFE JACKET

The Scuba Vest is made of specially prepared material saturated with a special leak-proof coating. The vest is inflated by a "Squeeze-Grip" detonator that allows easy removal of the 12 gram CO₂ cartridge.

PROFESSIONAL SCUBA VEST LIFE JACKET

CATALOG NO. 1988

PRICE \$14.95

C—CO₂ CARTRIDGES

CATALOG NO. 1982-01

PRICE \$.85 each

16 gram cartridge to fit Competition Life Jacket.

CATALOG NO. 1989

PKG. of 6

PRICE \$1.80

12 gram cartridge to fit Scuba Vest Life Jacket.

D—DETONATOR

For use with Scuba Vest Life Jacket.

CATALOG NO. 1988-02

PRICE \$3.00

E—COMPETITION KNIFE AND SHEATH

The Competition knife blade is made of Series 300 stainless steel and is guaranteed not to rust. Sheath design allows attaching to calf of leg.

COMPETITION KNIFE AND SHEATH

CATALOG NO. 1993

PRICE \$9.95

F—BALBOA KNIFE AND SHEATH

A compact utility knife, ideal for divers, fishermen, hunters, etc., with exclusive holster sheath design. Knife blade is made of Series 300 stainless steel.

BALBOA KNIFE AND SHEATH

CATALOG NO. 1995

PRICE \$7.50

G—COMPETITION 200 FT. DEPTH GAUGE

An accurate, leak-proof Bourdon tube gauge double sealed in form fitting stainless steel case.

COMPETITION 200 FT. DEPTH GAUGE

CATALOG NO. 1960

PRICE \$12.95

H—BALBOA 250 FT. DEPTH GAUGE

An accurate, fool-proof gauge with no mechanical parts. Gauge works on water pressure for absolute accuracy.

BALBOA 250 FT. DEPTH GAUGE

CATALOG NO. 1965

PRICE \$6.00

J—SCUBALITE

The Scubalite with 80,000 candlepower is the most powerful diving light ever developed for SCUBA divers. The one piece body is completely water, pressure and corrosion proof. (Uses 6 standard "D" batteries, not included.)

SCUBALITE

CATALOG NO. 1991

PRICE \$16.95

K—COMPLETE STUDY OF SKINDIVING

The author, Ray Hoglund, presents a comprehensive and easy to read text on basic skin diving, SCUBA diving, physics and physiology of diving to fundamental safety procedures.

COMPLETE STUDY OF SKINDIVING

CATALOG NO. 1911

PRICE \$2.95

L—INFLATABLE DIVERS FLAG

CATALOG NO. 1969

PRICE \$1.95

M—UTILITY BAG/SAFETY FLOAT

CATALOG NO. 1992

PRICE \$4.95

N—BIG JIM DIVERS FLAG/BUOY

CATALOG NO. 1981

PRICE \$3.50



SURFBOARDS & SKI-DOOTERS

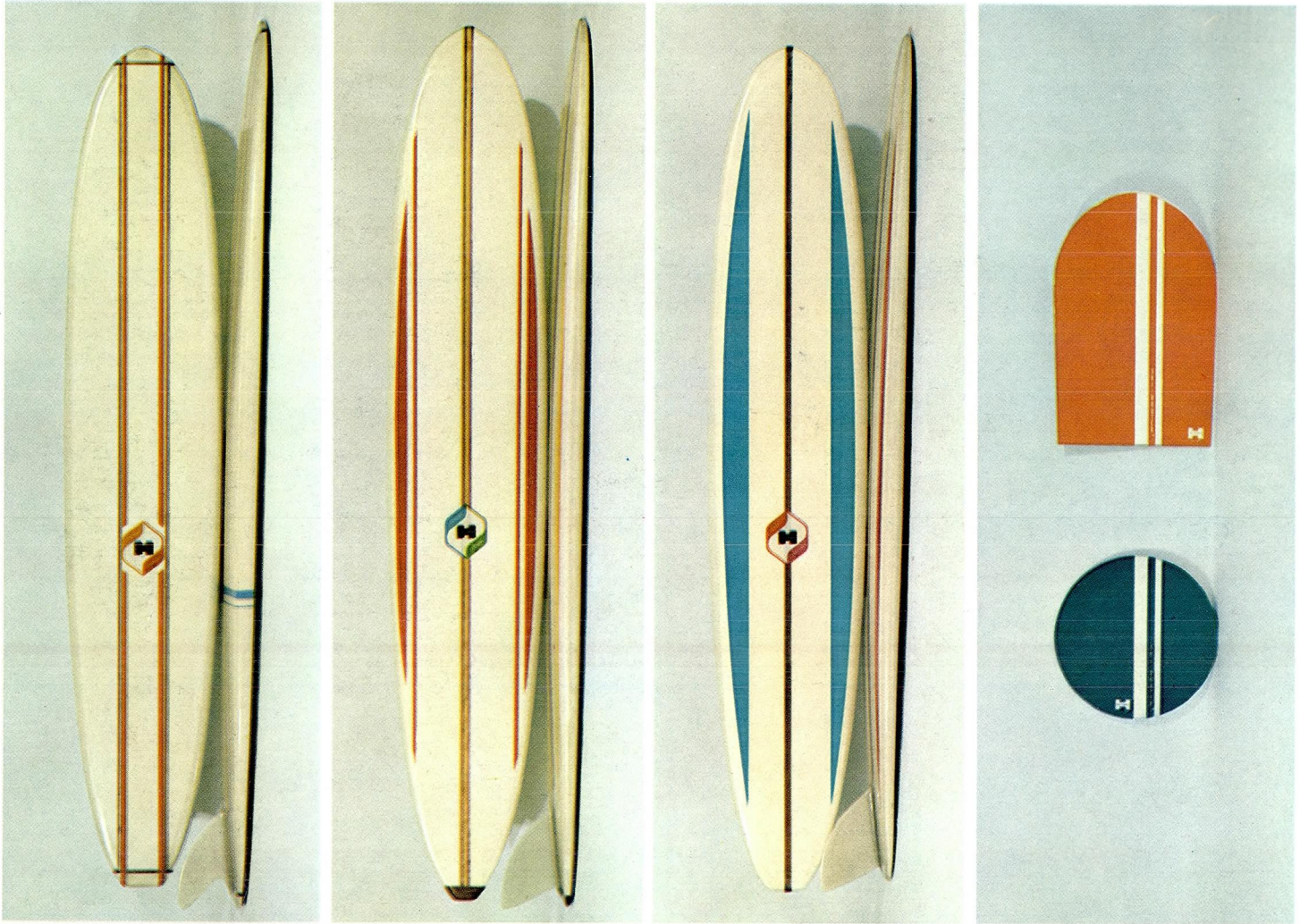

SURFBOARDS

Everyone involved in producing Healthways' Custom Surfboards are ardent surfers, each with more than five years experience surfing the greatest surfing beaches of the world. They take pride in their craftsmanship and build surfboards with the same care they would use if they were building their own.

Healthways' Custom Surfboards are hand crafted throughout the entire production cycle—they are truly a custom built board. The Glas-Cor blank is constructed of full 4 lb. density water blown polyurethane foam to retard discoloration and provide maximum dimensional stability. The blank is then bombarded with multiple layers of glass fibres for maximum strength and laboriously hand sanded to its final shape. Heavy 14 oz. Volon fiberglass cloth is hand applied over the entire board and extends to allow a double overlap on the rails for added strength and protection.

Three layers of polyester resin are applied over the fiberglass cloth and meticulously hand sanded to a super fine finish. The color resin is applied in custom designs in a dust free chamber. An additional layer of polyester resin is applied to provide a high gloss finish for added beauty. A detailed inspection is made before final packaging.

CUSTOM MACH 3

Additional features include: High density foam nose and tail block for added strength and durability • Finish is wet-sanded and buffed to provide the ultimate mirror-like finish • Unique 1/4" mahogany double stringers top and bottom • Solid fibreglass speed skeg.

CATALOG NO. 2187	2188
SIZE 9 ft. 6 in.	9 ft. 10 in.
PRICE \$165.00	\$165.00

WAIKIKI CUSTOM

Additional features include: Contrast mahogany and pine "T Band" stringer top and bottom • Solid imported mahogany tail block • Solid fibreglass skeg • Custom finish color designs.

CATALOG NO. 2191	2192	2193
SIZE 9 ft. 6 in.	9 ft. 10 in.	10 ft.
PRICE \$150.00	\$150.00	\$150.00

CALIFORNIA CUSTOM

Additional features include: 3/4" redwood stringer top and bottom • Solid fibreglass skeg • Custom finish color design.

CATALOG NO. 2196	2197	2198
SIZE 9 ft. 2 in.	9 ft. 6 in.	9 ft. 10 in.
PRICE \$132.50	\$132.50	\$132.50

SKI-DOOTERS

The Ski-Dooter can be used with ease at the ocean or lake by skimming across the receding waves as they race across the sand and may even be used on wet grass. The Ski-Dooter is constructed of special marine plywood and attractively finished in blue or orange with white racing stripes.

CATALOG NO. 2101*	2102
SIZE 24 IN. DIA. x	2 FT. x 3 FT. x
3/8 IN. THICK	1/2 IN. THICK
PRICE \$5.50	\$9.95

*Sorry, out of stock balance 1967. Suggest substituting 2102 above.



MEN'S BALBOA JACKETS

An ideal jacket for skin diver, surfer or water skier. Features: Full contour design • Heavy duty brass zipper • Full length crotch strap • Double duty snap patch.

3/16" BLACK NEOPRENE—SKIN TWO SIDES
 0601 Small.....\$23.00 0603 Med-Large..\$23.00
 0602 Medium..\$23.00 0604 Large.....\$23.00

1/8" BLACK NEOPRENE—NYLON LINED
 0660 Small.....\$24.00 0662 Med-Large..\$24.00
 0661 Medium..\$24.00 0663 Large.....\$24.00

1/8" RED NYLON SURFACE
 0664 Small.....\$24.00 0666 Med-Large..\$24.00
 0665 Medium..\$24.00 0667 Large.....\$24.00

1/8" BLUE NYLON SURFACE
 0668 Small.....\$26.00 0670 Med-Large..\$26.00
 0669 Medium..\$26.00 0671 Large.....\$26.00

THERMO-VESTS

A contoured form fitting vest for use as added protection on cold water divers or protection against wind while surfing or skiing.

1/8" BLACK NEOPRENE SKIN ONE SIDE
 0625 Small \$8.50
 0626 Medium \$8.50
 0627 Large \$8.50

1/8" RED FRONT/BLACK BACK NYLON SURFACE
 0628 Small \$13.50
 0629 Medium \$13.50
 0630 Large \$13.50

MEN'S "OUTRIGGER" SURFER SUITS

A must for the fashion conscious surfer or skier. Features: One piece construction for maximum strength and durability • Full Contour design • Reinforced shoulder snap for easy entry and removal • Complete freedom of movement.

1/8" BLACK NEOPRENE WITH NYLON LINING
 0640 Small \$22.50
 0641 Medium \$22.50
 0642 Med-Large \$22.50
 0643 Large \$22.50

1/8" RED NYLON SURFACE
 0648 Small \$25.00
 0649 Medium \$25.00
 0650 Med-Large \$25.00
 0651 Large \$25.00

1/8" BLUE NYLON SURFACE
 0652 Small \$26.00
 0653 Medium \$26.00
 0654 Med-Large \$26.00
 0655 Large \$26.00

WOMEN'S AQUAFEMME JACKET

An ideal jacket for skin diver, surfer or water skier. Features: Form fitting custom contour design • Heavy duty brass zipper • Full length crotch strap • Double duty snap patch.

1/8" BLUE NYLON SURFACE
 0676 Small \$25.00
 0677 Medium \$25.00
 0678 Med-Large \$25.00
 0679 Large \$25.00

WOMEN'S "OUTRIGGER" SURFER SUITS

A must for the fashion conscious surfer or skier. Features: Form fitting custom contour design • Heavy duty brass zipper • Complete freedom of movement.

1/8" BLUE NYLON SURFACE
 0635 Small \$26.00
 0636 Medium \$26.00
 0637 Med-Large \$26.00
 0638 Large \$26.00

UNDERWATER EXPOSURE SUITS

TEX-SKIN "NYLO-FOAM" 5 ZIPPER SUITS

Two piece suit constructed of textured neoprene bonded to "four-way" stretch nylon lining for added strength and tear resistance. Tex-Skin suits feature: Full contour design • Extra wide tuckaway zipper flap for added warmth • High waist pant design • Full quality nickel silver zippers • Twist lock fasteners • Offset end seams for extra strength.

3/16" TEX-SKIN "NYLO-FOAM" 5 ZIPPER SUIT

CAT. NO. 0540	SIZE/SMALL-MEDIUM	PRICE \$60.00
CAT. NO. 0541	SIZE/MEDIUM	PRICE \$60.00
CAT. NO. 0542	SIZE/MEDIUM-LARGE	PRICE \$60.00
CAT. NO. 0543	SIZE/LARGE	PRICE \$60.00

1/4" TEX-SKIN "NYLO-FOAM" 5 ZIPPER SUIT

CAT. NO. 0545	SIZE/SMALL-MEDIUM	PRICE \$64.00
CAT. NO. 0546	SIZE/MEDIUM	PRICE \$64.00
CAT. NO. 0547	SIZE/MEDIUM-LARGE	PRICE \$64.00
CAT. NO. 0548	SIZE/LARGE	PRICE \$64.00

SEALSKIN "NYLO-FOAM" 5 ZIPPER SUITS

Two piece suit constructed of a smooth skin neoprene bonded to "four-way" stretch nylon lining for added strength and tear resistance. Sealskin suits feature: Full contour design • Nickel finish zippers • Twist lock fasteners • Offset end seams for extra strength.

3/16" SEALSKIN "NYLO-FOAM" 5 ZIPPER SUIT

CAT. NO. 0510	SIZE/SMALL	PRICE \$52.00
CAT. NO. 0511	SIZE/SMALL-MEDIUM	PRICE \$52.00
CAT. NO. 0512	SIZE/MEDIUM	PRICE \$52.00
CAT. NO. 0513	SIZE/MEDIUM-LARGE	PRICE \$52.00
CAT. NO. 0514	SIZE/LARGE	PRICE \$52.00
CAT. NO. 0515	SIZE/EXTRA-LARGE	PRICE \$52.00

1/4" SEALSKIN "NYLO-FOAM" 5 ZIPPER SUIT

CAT. NO. 0520	SIZE/SMALL-MEDIUM	PRICE \$56.00
CAT. NO. 0521	SIZE/MEDIUM	PRICE \$56.00
CAT. NO. 0522	SIZE/MEDIUM-LARGE	PRICE \$56.00
CAT. NO. 0523	SIZE/LARGE	PRICE \$56.00

MEN'S SIZE CHART FOR DIVING SUITS ONLY

SMALL	5 ft. 4 in. to 5 ft. 7 in.	120 lbs. to 140 lbs.
SMALL-MED.	5 ft. 6 in. to 5 ft. 9 in.	140 lbs. to 160 lbs.
MEDIUM	5 ft. 8 in. to 5 ft. 11 in.	160 lbs. to 180 lbs.
MED.-LARGE	5 ft. 10 in. to 6 ft.	175 lbs. to 195 lbs.
LARGE	5 ft. 11 in. to 6 ft. 1 in.	190 lbs. to 210 lbs.
EXTRA-LARGE	6 ft. to 6 ft. 4 in.	200 lbs. to 240 lbs.

SIZE CHART FOR SURF & SKI JACKETS ONLY

MEN'S

SMALL	5 ft. 4 in. to 5 ft. 7 in.	120 lbs. to 140 lbs.
MEDIUM	5 ft. 6 in. to 5 ft. 9 in.	140 lbs. to 170 lbs.
MED.-LARGE	5 ft. 8 in. to 5 ft. 11 in.	160 lbs. to 190 lbs.
LARGE	5 ft. 10 in. to 6 ft. 2 in.	180 lbs. to 210 lbs.

WOMEN'S

		BUST TO:	WHT. TO:
SMALL	5 ft. to 5 ft. 3 in.	34 in.	115 lbs.
MEDIUM	5 ft. 2 in. to 5 ft. 5 in.	36 in.	130 lbs.
MED.-LARGE	5 ft. 4 in. to 5 ft. 7 in.	38 in.	145 lbs.
LARGE	5 ft. 6 in. to 5 ft. 9 in.	40 in.	160 lbs.



NEW IMPROVED



NEW



A



B



C



D



E



F



G



H

DIVING HOODS

A—TEX-SKIN "NYLO-FOAM" COLD WATER HOOD
Constructed of textured neoprene with "four-way" stretch nylon lining with contoured chin and flared skirt design to fit over shoulder and back for added warmth.

3/16" TEX-SKIN "NYLO-FOAM" COLD WATER HOOD
CAT. NO. 0720 SIZE/MEDIUM-SMALL PRICE \$7.50
CAT. NO. 0721 SIZE/MEDIUM-LARGE PRICE \$7.50

1/4" TEX-SKIN "NYLO-FOAM" COLD WATER HOOD
CAT. NO. 0723 SIZE/MEDIUM-SMALL PRICE \$8.50
CAT. NO. 0724 SIZE/MEDIUM-LARGE PRICE \$8.50

B—SEALSKIN "NYLO-FOAM" COMPETITION HOOD
Constructed of smooth skin neoprene with "four-way" stretch nylon lining with contoured chin and long neck design for added protection.

3/16" SEALSKIN "NYLO-FOAM" COMPETITION HOOD
CAT. NO. 0732 SIZE/MEDIUM-SMALL PRICE \$6.50
CAT. NO. 0733 SIZE/MEDIUM-LARGE PRICE \$6.50

1/4" SEALSKIN "NYLO-FOAM" COMPETITION HOOD
CAT. NO. 0736 SIZE/MEDIUM-SMALL PRICE \$7.00
CAT. NO. 0737 SIZE/MEDIUM-LARGE PRICE \$7.00

SEALSKIN "NYLO-FOAM" PROFESSIONAL HOOD (not shown)
Constructed of smooth skin neoprene with "four-way" stretch nylon lining with full contour design.

3/16" SEALSKIN "NYLO-FOAM" PROFESSIONAL HOOD
CAT. NO. 0734 SIZE/MEDIUM-SMALL PRICE \$6.00
CAT. NO. 0735 SIZE/MEDIUM-LARGE PRICE \$6.00

DIVING BOOTS

C—SEALSKIN "NYLO-FOAM" HARD SOLE BOOTS
Constructed of smooth skin neoprene with "four-way" stretch nylon lining with molded link design hard neoprene sole and inner sole of foam neoprene for added comfort.

3/16" SEALSKIN "NYLO-FOAM" HARD SOLE BOOTS
CAT. NO. 0744 SIZE/5-7 PRICE \$9.50
CAT. NO. 0745 SIZE/7-9 PRICE \$9.50
CAT. NO. 0746 SIZE/9-11 PRICE \$9.50

1/4" SEALSKIN "NYLO-FOAM" HARD SOLE BOOTS
CAT. NO. 0747 SIZE/5-7 PRICE \$10.50
CAT. NO. 0748 SIZE/7-9 PRICE \$10.50
CAT. NO. 0749 SIZE/9-11 PRICE \$10.50

SEALSKIN "NYLO-FOAM" SOFT SOLE BOOTS (not shown)
Constructed of smooth skin neoprene with "four-way" stretch nylon lining.

3/16" SEALSKIN "NYLO-FOAM" SOFT SOLE BOOTS
CAT. NO. 0738 SIZE/5-7 PRICE \$6.50
CAT. NO. 0739 SIZE/7-9 PRICE \$6.50
CAT. NO. 0740 SIZE/9-11 PRICE \$6.50

1/4" SEALSKIN "NYLO-FOAM" SOFT SOLE BOOTS
CAT. NO. 0741 SIZE/5-7 PRICE \$7.00
CAT. NO. 0742 SIZE/7-9 PRICE \$7.00
CAT. NO. 0743 SIZE/9-11 PRICE \$7.00

SEALSKIN "NYLO-FOAM" GLOVES & MITTS

Constructed of smooth skin neoprene with "four-way" stretch nylon lining.

D—5 FINGER GLOVES
CAT. NO. 0753 SIZE/SMALL PRICE \$8.00
CAT. NO. 0754 SIZE/MEDIUM PRICE \$8.00
CAT. NO. 0755 SIZE/LARGE PRICE \$8.00

E—3 FINGER MITTS
CAT. NO. 0750 SIZE/SMALL PRICE \$6.50
CAT. NO. 0751 SIZE/MEDIUM PRICE \$6.50
CAT. NO. 0752 SIZE/LARGE PRICE \$6.50

F—AERO SPRAY RUBBER DUST
Concentrated Rubber Dust in easy to use aerosol can.
CAT. NO. 1797 PRICE \$1.00

G—RUBBER DUST
CAT. NO. 1791 PRICE \$.90

H—BLACK MAGIC NEOPRENE CEMENT
CAT. NO. 1798 SIZE/4 OZ. PRICE \$1.35

"NYLO-FOAM" REPAIR KIT (not shown)
CAT. NO. 1795 PRICE \$2.50

ALL PRICES SHOWN ARE SUGGESTED RETAIL PRICES



JOIN HEALTHWAYS' FULL PRODUCT PROGRAM FOR 1967. A ONE SOURCE SUPPLY FOR A COMPLETE LINE OF PROFESSIONAL QUALITY SPORTING GOODS.

GENERAL OFFICE, MAIN FACTORY
AND WAREHOUSE
P.O. BOX 45055
5340 W. 102 STREET
LOS ANGELES, CALIFORNIA 90045
(213) 776-4370

EASTERN WAREHOUSE
1029 ATLANTIC AVENUE
BROOKLYN 38, NEW YORK
(212) ST 9-1662
(212) 789-1662