

**SAV**

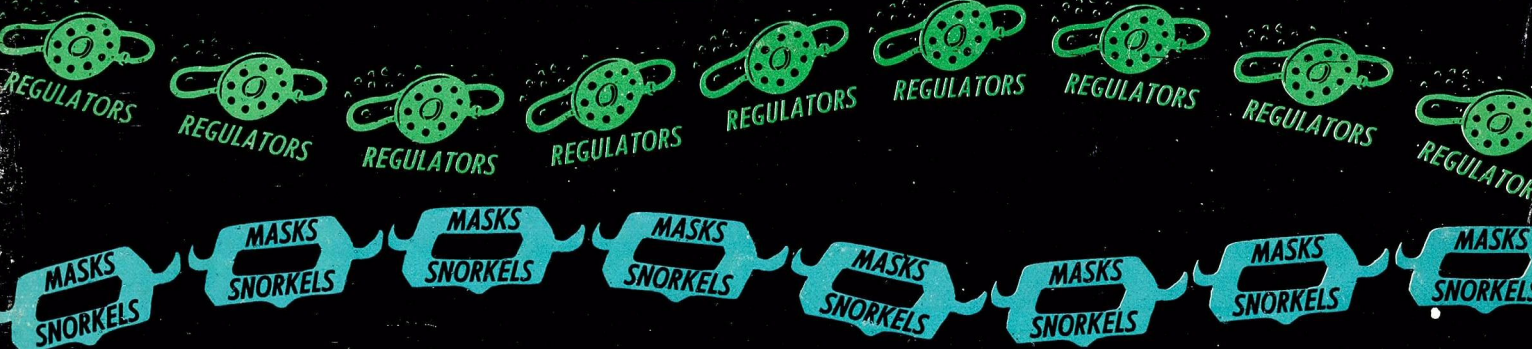

**SPORTSWAYS**

7701 EAST COMPTON BLVD. PARAMOUNT, CALIF. 90724, Phone (213) 636-0161

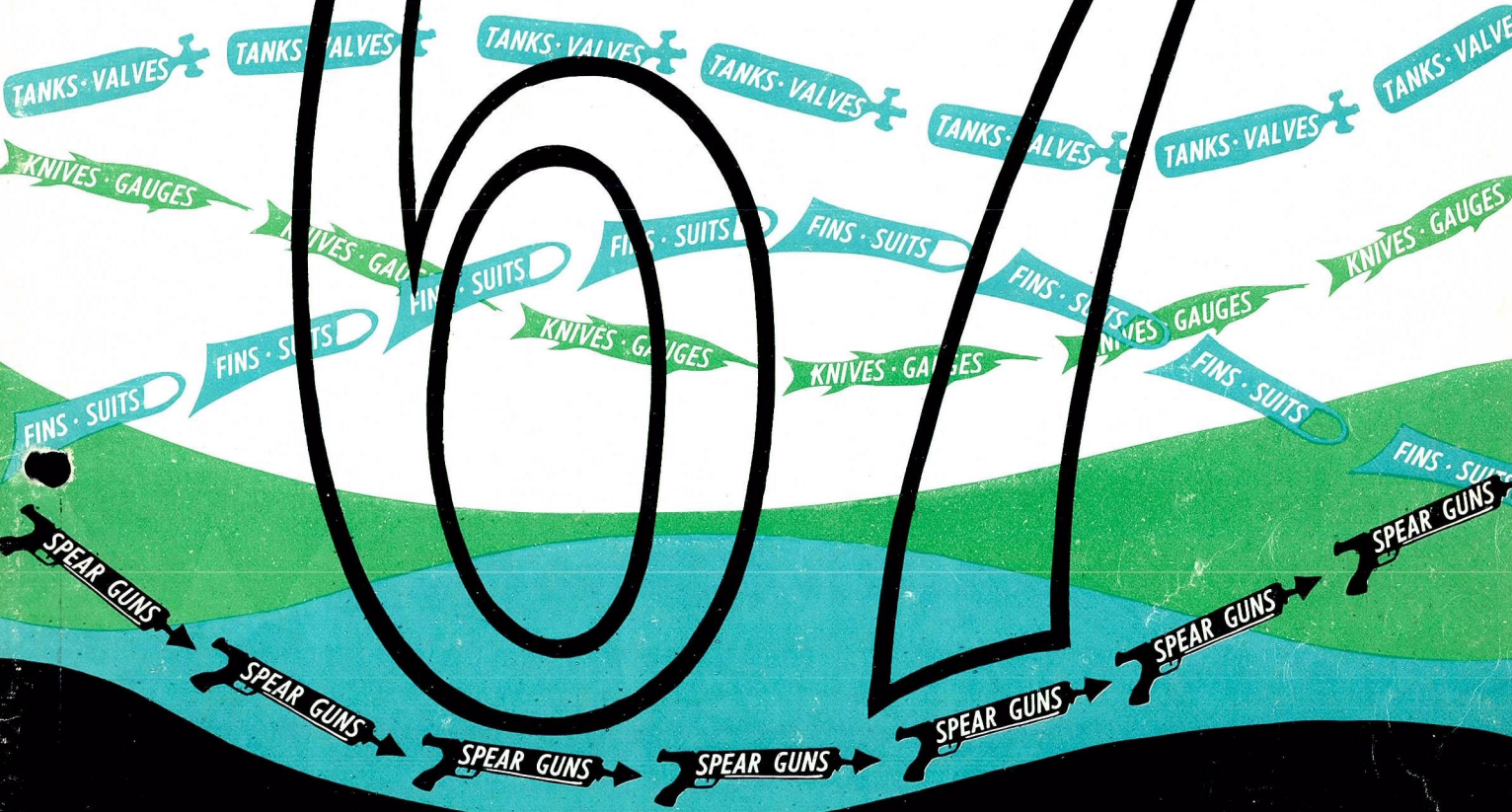
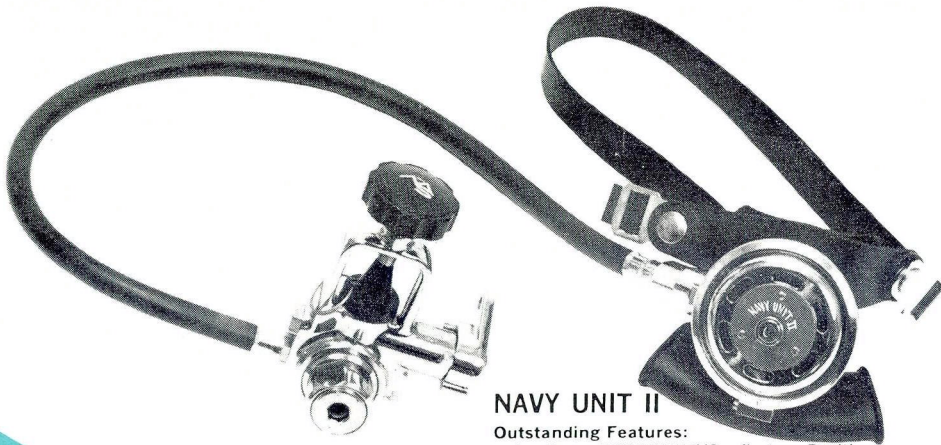

**NAVY UNIT II**

**Outstanding Features:**

Another SPORTSWAYS first — Positive cam-activated, spring-loaded reserve mechanism is an integral part of solid first stage body. Second stage has refined "downstream" valve design.

All moving parts made of stainless steel treated with SPORTSWAYS DRY-LUBE to reduce friction and wear. Triple plated chrome inside and outside.

- 1375 "Navy Unit II" WATERLUNG Regulator.....
- 1376 "Navy Unit II" with Sea Vue Gauge.....
- 1377 "Navy Unit II" for use with double tank.....
- 1378 "Navy Unit II" for use with double tank units with Sea Vue Gauge .....

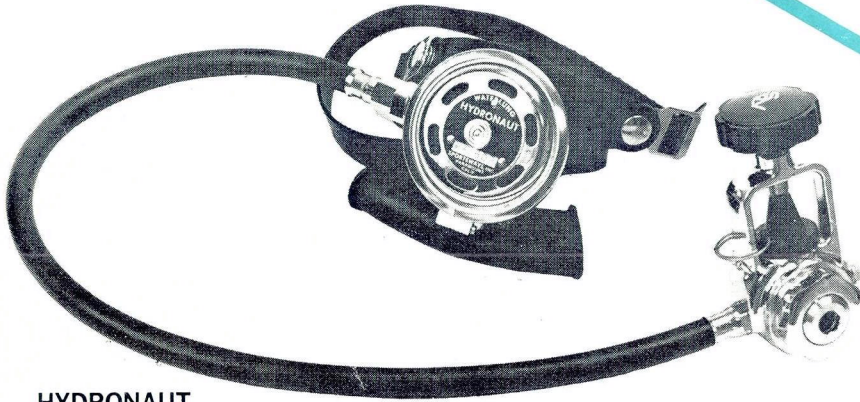

**HYDRONAUT**

**Outstanding Features:**

New concept in balanced breathing allows constant pressure and flow regardless of tank pressure.

Second stage "downstream" valve delivers 22 cu. ft. of air with an effort too small to be measured.

All vital metal parts made of stainless steel for highest tensile strength. Moving parts coated with the new SPORTSWAYS DRY-LUBE, an anti-friction agent.

Triple-plated chrome inside and outside.

- 1340 "Hydronaut" Waterlung Regulator.....
- 1341 "Hydronaut" Waterlung with Sea-View Gauge.....

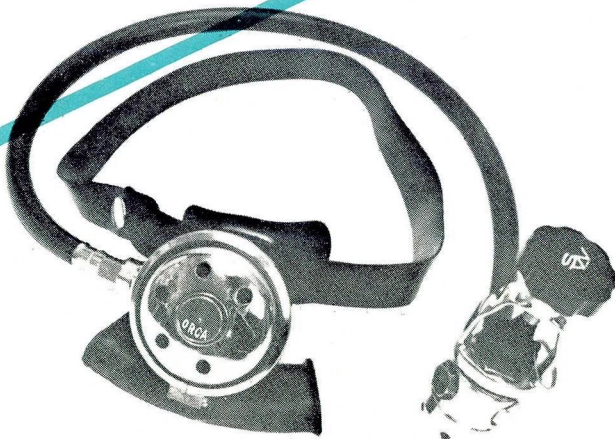

**ORCA**

**Orca Regulator Packaged in Regulator Carrying Bag**

A standby regulator by SPORTSWAYS . . . Designed to meet our highest quality standards.

Pre-set "piston type" first stage, reliable and simple SPORTSWAYS "downstream valve" made of stainless steel in second stage.

- 1395 "Orca" Waterlung Regulator.....
- 1396 "Orca" Waterlung with Sea-View Gauge.....

**WATERLUNG**



**MALIBU DIVER**

Malibu Regulator Packaged in Regulator Carrying Bag

**Outstanding Features:**

Fine performance and workmanship at an economy price.  
 Pre-set "piston-type" first stage, reliable and simple.  
 EZ breathe rocker valve assembly in second stage.

1330 "Malibu Diver" Waterlung Regulator.....

1331 "Malibu Diver" with Sea-View Gauge.....



**SPORT DIVER**

**Outstanding Features:**

The world's most popular regulator EZ breathe rocker valve assembly makes this the best selling single hose regulator on the market today. Solid brass forging, chrome plated inside and outside.

1301 "Sport Diver" Waterlung Regulator.....

1302 "Sport Diver" with Sea-View Gauge.....

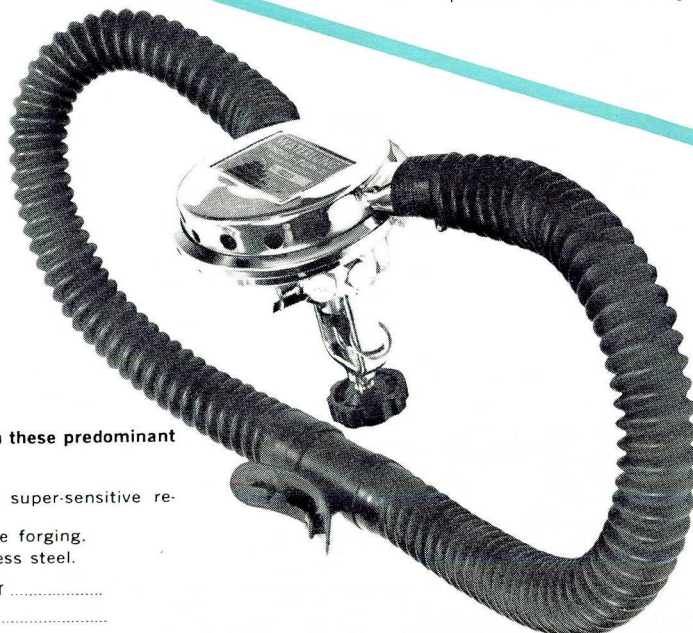

**HYDRO-TWIN II**

The only two-hose regulator made with these predominant features:

- First stage "balanced valve".
- Large demand diaphragm provides super-sensitive response.
- Sea-View Gauge port. Solid one piece forging.
- All vital metal parts made of stainless steel.

1350 "Hydro Twin II" WATERLUNG Regulator .....

1351 "Hydro Twin II" with Sea View Gauge .....

**REGULATORS**

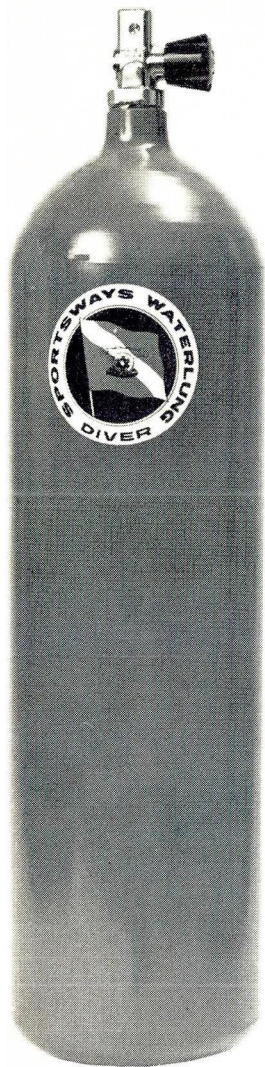

Also available,  
Yellow and Black

- 1001 Bare Tank, 71.2 cu. ft., Galv.
- 1002 Bare Tank, 71.2 cu. ft. Orange .....
- 1011-1 "SK" Valve Single Tank Assembly. 71.2 cu. ft. Galv. Less Pac .....
- 1012-1 "SK" Valve Single Tank Assembly. 71.2 cu. ft. Orange, Less Pac....
- 1013-1 "SJ" Valve Single Tank Assembly. 71.2 cu. ft., Galv., Less Pac .....
- 1014-1 "SJ" Valve Single Tank Assembly. 71.2 cu. ft., Orange, Less Pac .....

### PULL RODS

- 1116 Pull Rod, SJ Portable, Stainless Steel .....
- 1117 Pull Rod, Double Tank, Stainless Steel .....
- 1204-22 Pull Rod, Cam-Pac, Stainless Steel .....
- 1320-22 Pull Rod, Navy Unit Dbl., Stainless Steel .....

SPORTSWAYS tanks feature the 3/4" and 15/16" opening with "O" ring seal straight thread. The only system that meets military specifications for pressure seals. (MIL-P-5514). When the tank is empty the valve can be easily removed for visual inspection without special tools. SPORTSWAYS valves have exclusive "Safety Port" that vents off pressure and provides warning, preventing accidental removal when there is pressure in the tank. All tanks galvanized, and orange yellow & black exterior.



### THE "BIG INCH"—"O" RING SEALED

15/16" Opening

II SPORTSWAYS Tanks are Galvanized prior to applying the Exterior coating to Prevent Rusting.

- 701-1 Bare Tank, 71.2 cu. ft. Galvanized.....
- 701-2 Bare Tank, 71.2 cu. ft. Yellow.....
- 701-3 Bare Tank, 71.2 cu. ft. Orange.....
- 701-4 Bare Tank, 71.2 cu. ft. Black.....

### ALL COATED TANKS—

**(ORANGE, YELLOW AND BLACK)  
ARE GALVANIZED FIRST, THEN  
COATED TO PREVENT RUSTING.**

### SINGLE TANK ASSEMBLIES

- 702-1 Single Galv. 71.2 cu. ft. tank with SK Valve..
- 702-2 Single Yellow 71.2 cu. ft. tank with SK Valve..
- 702-3 Single Orange 71.2 cu. ft. tank with SK Valve..
- 702-4 Single Galv. 71.2 cu. ft. tank with SJ Valve....
- 702-5 Single Yellow 71.2 cu. ft. tank with SJ Valve..
- 702-6 Single Orange 71.2 cu. ft. tank with SJ Valve..
- 702-13 Single Black 71.2 cu. ft. tank with SK Valve
- 702-14 Single Black 71.2 cu. ft. tank with SJ Valve

### DOUBLE TANK ASSEMBLIES

- 708-1 Double Galv. Tanks with SK2 Valve, with Contour Pac
- 708-3 Double Orange Tanks with SK2 Valve, with Contour Pac
- 708-7 Double Galv. Tanks with SJ2 Valve with Contour Pac
- 708-8 Double Yellow Tanks with SJ2 Valve with Contour Pac
- 708-9 Double Orange Tank with SJ2 Valve with Contour Pac
- 708-15 Double Black Tank with "SK2" Valve with Contour Pac



**"SK" SHUT-OFF VALVE**

SK Tank Valve 3/4" Straight Pipe Thread for 15/16" Tank Opening.

704 .....

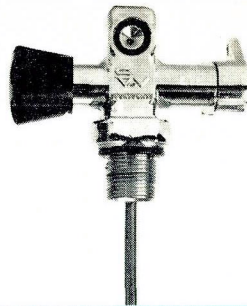

**"SJ" CONSTANT RESERVE VALVE**

SJ Tank Valve 3/4" Straight Pipe Thread for 15/16" Tank Opening.

704A .....

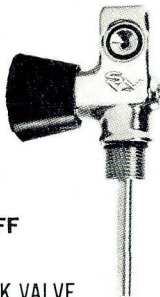

**"SK" SHUT-OFF VALVE**

1115 "SK" TANK VALVE  
3/4" Straight Thread.....

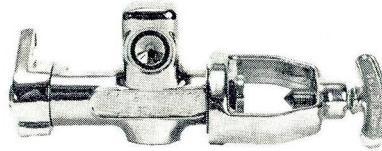

**RESERVE VALVE**

1101 "SJ" Demountable Portable  
Spring-Loaded Constant Reserve

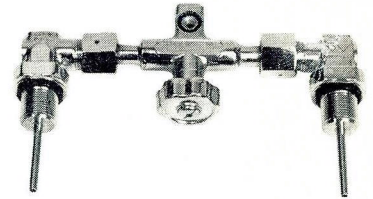

**"SK2" DOUBLE TANK MANIFOLD**

SK2 Double Tank Manifold 3/4" Straight Pipe Thread for 15/16" Tank Opening.

704B .....

TRIPLE CHROME PLATED  
**TANK VALVES**



**"SJ" CONSTANT RESERVE VALVE**

1112 "SJ" SPRING-LOADED  
CONSTANT RESERVE  
VALVE (300 PSI)  
3/4" Straight Thread.....



**WATERLUNG TANK BOOT**

Protective boot slips snugly over the bottom of any standard diameter cylinder. Made of black synthetic material which will not mark or mar surfaces. Flat bottom allows the cylinder to remain in vertical position.

1050 Waterlung Tank Boot (black) .....

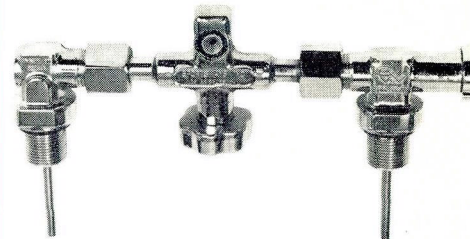

**"SJ2" DOUBLE TANK MANIFOLD**

SJ2 Double Tank Manifold 3/4" Straight Pipe Thre. for 15/16" Opening.

704C .....

## TANK PACKS

**SPORTSWAYS EXCLUSIVE  
CAM-ACTION RELEASE PERMITS  
MOUNTING ON OR REMOVAL FROM  
TANK IN SECONDS**



**1207 CAM-PAC II**  
orange harness

**1211 CAM-PAC II—**  
black harness

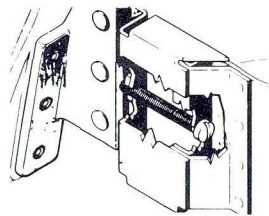

## QUICK RELEASE ASSEMBLY CONTOUR-PACS

Sportsways Contour-Pacs feature all the comforts and durability of the Cam-Pac II with the cam-action. The metal tank band adjusts for position and tightness by a single galvanized bolt. Harness is orange or black nylon webbing for strength and rapid drying. Quick release D-ring assemblies throughout.

**1205 CONTOUR-PAC—** orange harness  
(for single tank assembly) .....

**1209 CONTOUR-PAC—**black harness  
(for single tank assembly).....

**1206 CONTOUR-PAC—**orange harness  
(for double tank assembly) .....

**1213 CONTOUR-PAC—**black harness  
(for double tank assembly).....

## NON-SLIP SCREW ADJUSTMENT

Safety feature designed by Sportsways and featured on the Cam-Pac II. Screw adjustment allows easy tightening of the tank band to prevent possible tank slippage. All component parts are made of stainless steel for maximum durability.

# TANK PACKS - GAUGES



**"SEA-VUE"  
GAUGE**

The "Sea-View" Gauge is the most vital instrument ever designed for safety in diving. The equivalent of a fuel gauge in airplanes.

- Accurately indicates your remaining air supply at all-times.
- Allows you to plan your dive minute-to-minute.
- No need to demount regulator to check tank pressure.
- Waterproof, pressure proof construction with "O"-ring seals.
- Luminous dial.
- Chrome-plated Navy brass case and bezel.
- Stainless steel braided hose encased in neoprene.
- Each hose tested at 6,000 P.S.I.

**1401 SEA-VUE** Pressure Gauge



## WATERLUNG DEPTH GAUGE

Completely new original Sportsways design. Engineered for complete reliability in two ranges. The most accurate and durable in the underwater field.

High impact Cycolac case for maximum durability.

"O"-ring seal gauge cap for complete pressure proof seal.

Luminous markings and indicator for easy reading.

Exclusive mechanism design that permits removal for factory inspection and setting.

**1410 Waterlung** Depth Gauge  
250 ft. ....

**1411 Waterlung** Depth Gauge  
150 ft. ....

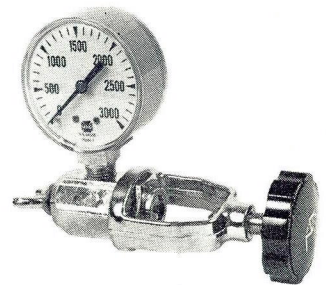

## TANK PRESSURE GAUGE & YOKE WITH BLEEDER VALVE

Brass case. Main body with bleeder valve — brass forging. Large thumb screw, easy to bleed. All chrome plated. With protective rubber case.

**1403** Tank Pressure Gauge and Yoke with Bleeder Valve .....

**1403-01** Bleeder Valve Thumb Screw .....

**"DIVER" KNIFE AND SHEATH**

- Extremely attractive, completely versatile diver's knife.
- Concave serrated area on opposite edge.

1630 Diver Knife (black handle) .....  
 1640 Diver Knife (orange handle) .....



**"NAVY" KNIFE AND SHEATH**

- Superb knife to meet all requirements — a sturdy working tool.
- Full-length cutting edge to tapered point, with large serrated area.

1631 Navy Knife (black handle) .....  
 1641 Navy Knife (orange handle) .....



**DIVERS KNIFE—STEELHEAD**

Stainless steel head. Versatile heavy-duty diver's knife.

713-3, Black Handle  
 713-4, Orange Handle



**DIVERS KNIVES - JACKETS**



**UNDERWATER COMPASS**

Completely accurate and easy to read. Design features revolving dome compass for stability. Liquid Filled. Durable jet black rubber case and strap.

1420 Sportsways Underwater Compass .....



**SKIN DIVERS JACKET**

<b>Cat. No.</b>	<b>Size</b>
723A-1	Small
723A-2	Medium
723A-3	Large

**COLOR:**  
 Brilliant Red w/White Strip

# "WATERLUNG" MASK

MADE BY CRAFTSMEN FOR EXPERTS

- ★ High efficiency, non-return exhaust valve for instant clearing, largest possible orifice.
- ★ Close-to-the-face design for increased vision and minimum displacement.
- ★ Flat grid exhalation port provides easier equalization.
- ★ Lens design provides 30% more visibility. Tempered safety glass lens.
- ★ Comfortable split head strap, adjustable from both sides for secure seal.
- ★ Hinged head strap buckles adds greater life to head strap.
- ★ Extruded foam neoprene sealing edge for a perfect seal and comfort.
- ★ Deluxe heavy duty mask bands.



1626 Waterlung mask with black anodized bands .....

1626-4 Band replacement kit for Waterlung Mask black anodized top and bottom bands, 2 band screws .....



## DOLPHIN JR. MASK

1910

Designed especially for the junior flipper fan. Beautifully contoured to fit the most exacting demands of the smaller face. Feathered edging makes for perfect sealing. Snug tight fit headstrap, locking to assure direct pull, eliminating crinkling edges. Tempered lens. Stainless steel band. Brass nickel plated buckles. Beautiful Ocean Blue color. Professionally split comfortable head strap. Extremely slanted lens providing better viewing for the diver. Short top skirt aids sealing.

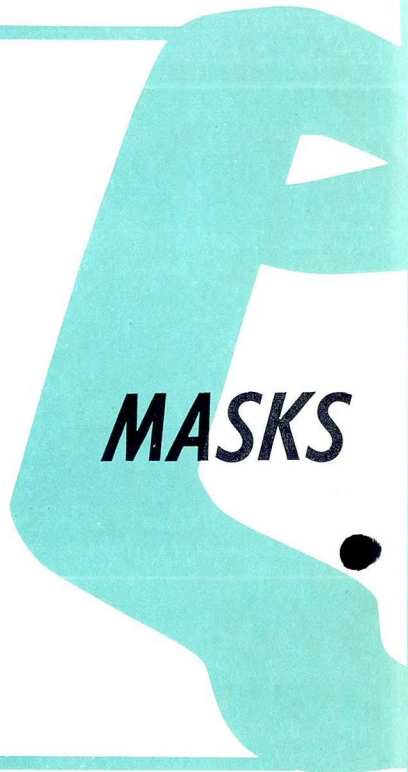

## DOLPHIN JUNIOR SWIM SET

The Dolphin Junior Swim Set incorporates the Dolphin Junior Flipper, Dolphin Junior Mask, and Dolphin Junior Snorkel available in three different fin sizes.

- |      |             |
|------|-------------|
| 1930 | Sizes 2 - 3 |
| 1931 | Sizes 3 - 4 |
| 1932 | Sizes 4 - 5 |

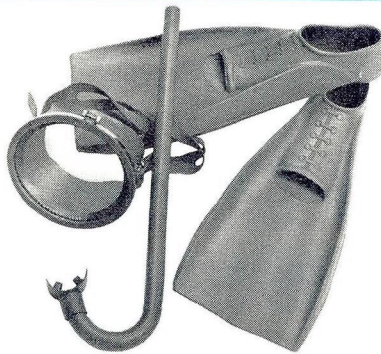

## DOLPHIN JR. SNORKEL

1900

Designed especially for the junior flipper fan. Soft contoured mouthpiece. All rubber one-piece tube. The professional look.

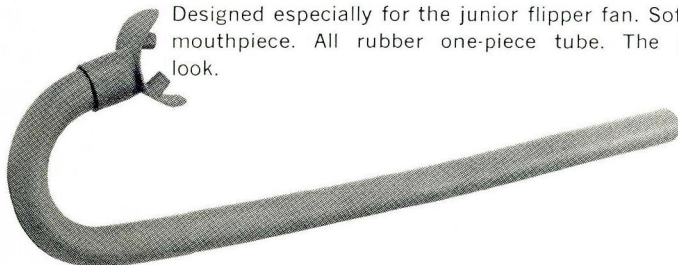

## DOLPHIN SR. FLEX SNORKEL

Cat. No. 1612

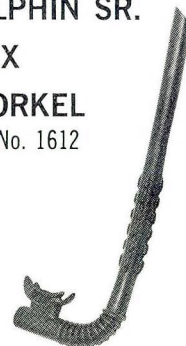

## AVALON SNORKEL

Cat. No. 1613

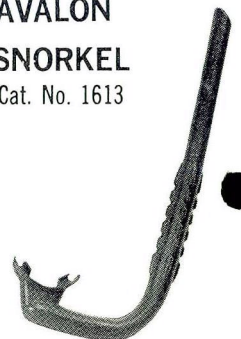





**"EQUALIZER PURGE"**

1628 "EQUALIZER PURGE" MASK with purge valve, black neoprene .....



**"VISTA-VUE" MASK**

Slanted lens design provides better viewing. Shorter top skirt aids sealing during ascent. Stainless steel rim and screw adjustment locks lens in safe position. Tempered safety glass lens, high quality blue rubber compound or black neoprene.

- 1650 "VISTA-VUE" French blue .....
- 1651 "VISTA-VUE" Black neoprene .....

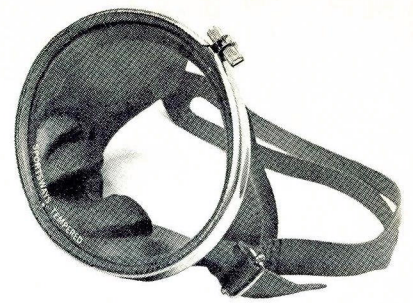

**"EQUALIZER" MASK**

Slanted lens "Vista-Vue" design with easy-grip equalizing feature. Deep-set easy-to-reach, double step recessions permit quick pressure relief without breaking face-mask seal. An exclusive Sportsways design.

- 1652 "EQUALIZER" MASK French Blue .....
- 1653 "EQUALIZER" MASK Black neoprene .....

**& - SNORKELS**



**SHARK MASK**

Anodized band. Protective band screw covering. Interlocking head strap. Tempered lens. Beautifully contoured.

706

**"CATALINA" SNORKEL**



The "Catalina" is designed for the pro diver. The "Catalina" is constructed of the finest black rubber and equipped with bellows mouthpiece.

1623 Catalina Snorkel .....

**"COMPETITOR" SNORKEL**

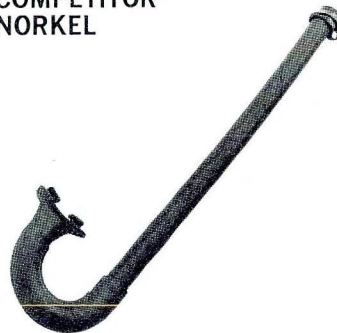

The only snorkel in the field constructed of neoprene . . . designed to provide sufficient volume of air under all conditions. One piece moulded elbow allows quick, easy clearing. The Competitor answers the need for an expert snorkel.

1614 Competitor Snorkel .....

**"WATERLUNG" SNORKEL**



The most efficient and comfortable snorkel ever developed. Flexible hose design provides complete freedom when inserting or removing mouthpiece. No twisting or pulling. Drops out of the way when not in use. New mouthpiece design has all edges contoured for complete comfort.

- 1620 Waterlung Snorkel — International Orange Tube .....
- 1621 Waterlung Snorkel—Jet Black Tube .....

## DOLPHIN JR. FLIPPERS

The fin that was designed for the ever-growing flipper fan. Designed to the exact demands found incorporated in our ever-popular "Waterlung Fins". Comfortable foot pocket. Contoured ribs. Adjustable to the growing foot. Instructions included with each pair of fins for their adaptation to the growing foot.

1920 Sizes 2 - 3  
 1921 Sizes 3 - 4  
 1922 Sizes 4 - 5



The WATERLUNG FINS incorporate all the requirements necessary for maximum utility — comfort — power — efficiency — durability.

This exclusive design features:

★ Full foot with high cut heel design for complete protection in or out of the water.

★ Specially contoured foot pockets provide unequaled comfort and perfect fit in all sizes.

★ Added blade length in both Regular and Giant sizes.

★ Tapered extra high external ribs for added power.

★ Ideal for use with or without boots. Available in Jet Black or Floating Blue

**SWIM**

Specially contoured foot pockets provide unequaled comfort and perfect fit in all sizes.

Full foot with high cut heel design for complete protection in or out of the water.

Tapered extra high external ribs for added power.

Added blade length in both Regular and Giant sizes.

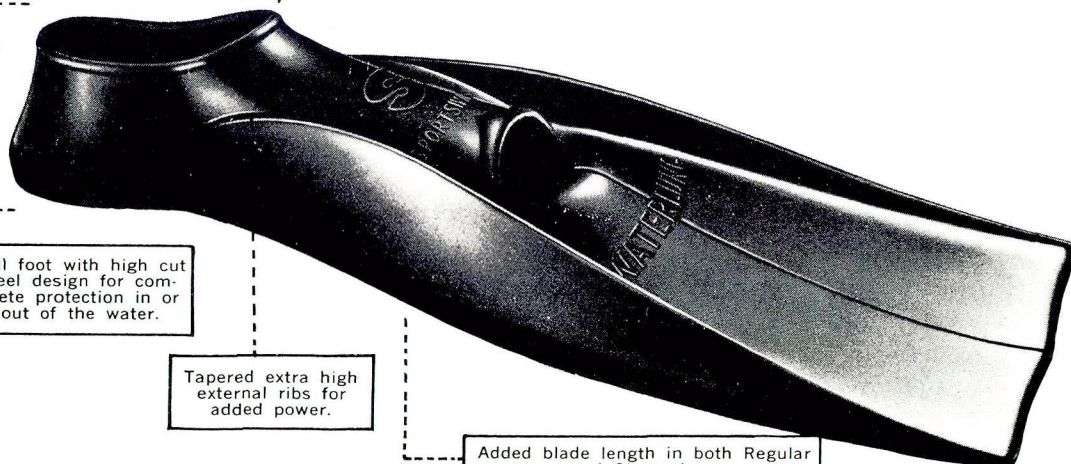

# ORCA FINS

The world's most powerful fins. ORCA FINS are unequalled for **thrust, speed and comfort**. Hydrodynamic design combines symmetry and rugged construction for maximum propulsion.

- Resilient compound for maximum wear and durability.
- Snug-fit contoured foot pocket ideal for use with or without boots.
- Extra long fin blade for added power.
- All edges and heel straps contoured, eliminating chafing, cramps and fatigue.
- Heavy, symmetrically tapered ribs for maximum power.
- Exclusive instep design provides unrivaled comfort and full instep contact for complete power transfer.

1565	Giant, Medium Large	Shoe Size 9½-10½	Gum
1566	Giant, Large	Shoe Size 11-13	Gum
1567	Giant, Extra Large	Shoe Size 13-14	Gum
1568	Giant, Super Extra Large	Shoe Size 14-16	Gum



**FINS**

## Jet Black

Cat. No.	Size	Color
1512	Reg., 4-5	Black
1513	Reg., 5½-6½	Black
1514	Reg., 7-8	Black
1515	Reg., 8½-9½	Black
1516	Reg., 10-11	Black
1517	Giant, 11½-13	Black
1518	Giant, 13½-16	Black

## Floating Blue

Cat. No.	Size	Color
1522	Reg., 4-5	Blue
1523	Reg., 5½-6½	Blue
1524	Reg., 7-8	Blue
1525	Reg., 8½-9½	Blue
1526	Reg., 10-11	Blue
1527	Giant, 11½-13	Blue
1528	Giant, 13½-16	Blue



The ultimate in spear guns. Developed from exclusive principles for maximum power — unequalled accuracy — complete durability — minimum maintenance. All stainless steel internal parts. Used in competition throughout the world.

- ★ Exclusive trigger release leverage system eliminates trigger pull resistance, no matter how many slings are used.
- ★ High impact Cycloc handles and muzzles eliminates internal corrosion and provides lightness and maneuverability.
- ★ Spear guns float after firing.
- ★ "O"-ring seals in the barrel, the only foolproof seal against water and pressure.
- ★ Cocking stock for balance, accuracy, quicker handling, and easier loading. Also can be used for storage of spear tips.
- ★ Automatic line release eliminates drag and veer. Out of the way of hands.
- ★ Stainless steel shaft with exclusive safety notch that eliminates slipping or accidental firing.
- ★ Fool-proof safety. Stainless steel internal part.

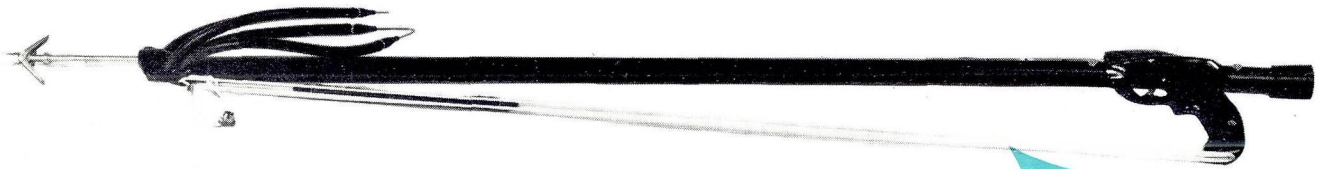

- 1635 "COMPETITOR" SPEAR GUN with Stainless Steel Two Barb Spearhead .....
- 1636 "SPORTSMAN" SPEAR GUN with Stainless Steel Single Barb Spearhead .....
- 1635-25 SLING (long) 21" Competitor .....
- 1635-28 SHAFT (long) S.S. Competitor .....

**SPEAR  
POINTS**

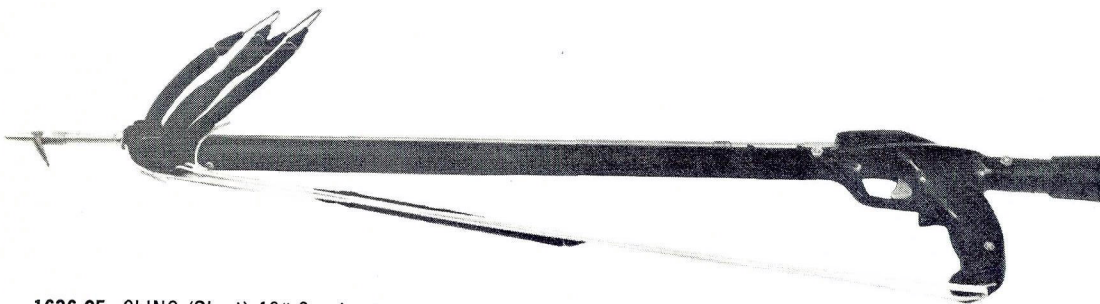

- 1636-25 SLING (Short) 13" Sportsman .....
- 1636-28 SHAFT (Short) S.S. Sportsman .....
- 1635-3 MUZZLE .....

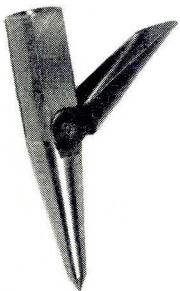

**SINGLE BARB  
SPEARHEAD**  
Stainless steel  
1636-51



**TWO-BARB  
SPEARHEAD**  
stainless steel,  
retractable  
1635-52

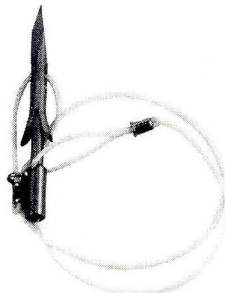

**DETACHABLE TRI-CUT  
SPEARHEAD**  
716



**THREE-PRONG  
TRIDENT FORK**  
710



**THREE-PRONG  
FORK**  
729-1

## FROGMAN SEA SPEAR

719



Solid fiberglass rod. Power sling: rugged surgical rubber. All fittings corrosion resistant. American thread. Three-prong spear head. Length - 4'.

## SPORTSMAN SEA SPEAR

719A

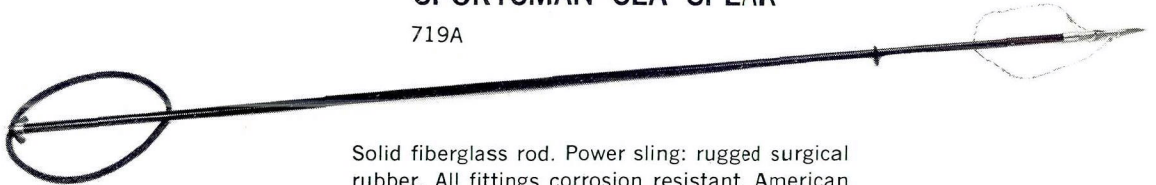

Solid fiberglass rod. Power sling: rugged surgical rubber. All fittings corrosion resistant. American thread. 3" slip tip detachable tri-cut spearhead. Length - 5'6".

## COMPETITOR SEA SPEAR

719B

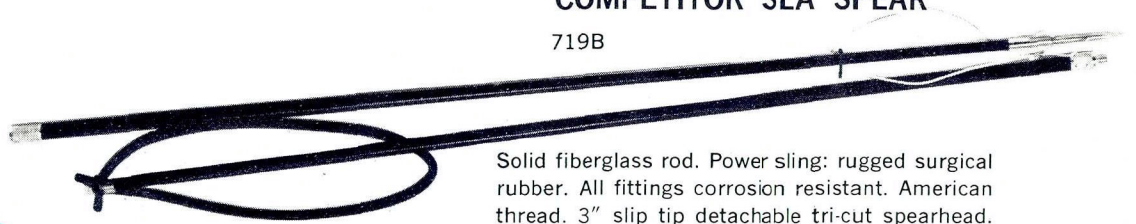

Solid fiberglass rod. Power sling: rugged surgical rubber. All fittings corrosion resistant. American thread. 3" slip tip detachable tri-cut spearhead. Length - 7'6".

**GUNS**

**SPEARS**

## FROGMAN GUN

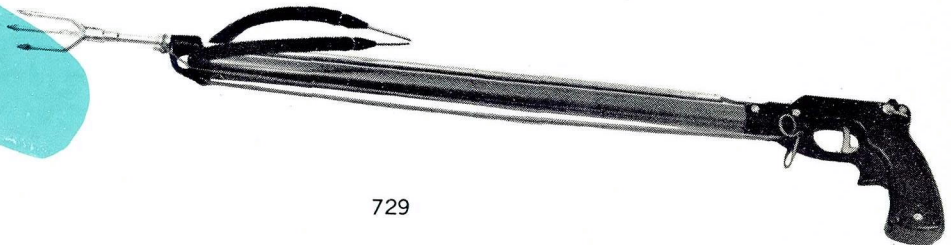

729

## ZUKA-SLURP GUN

1639



Zuka-Slurp Gun manufactured of genuine P.V.C. Pump type action. Detachable fish traps, linear polyethylene. Adjustable length. Metal parts corrosion resistant. Free of maintenance. Extra fish traps available. This is a realistic approach to "slurping". Overall length - 42".

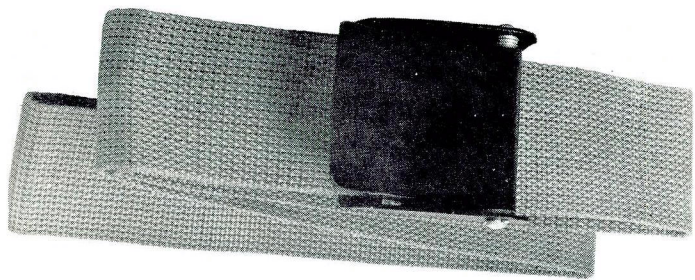

**"HYDRO-BELT"**

- Airplane type quick-release, all metal buckle. Black anodized finish.
- 2" orange or black nylon belt.
- Stainless steel spring and pivot pin.
- Easy to slip lead weights on and off.

1291 Hydro-Belt, orange .....

1293 Hydro-Belt, black.....

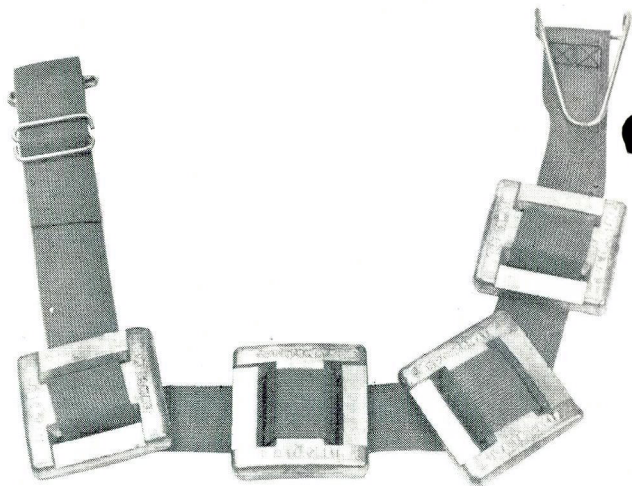

**WEIGHT BELTS & ACCESSORIES**

Cat. No. 1287 2" Pro  
Weight Belt with  
Four 3-lb. "Snug-  
Fit" Weights .....

# WEIGHT BELTS



**"SNUG FIT" 3 LB. LEAD WEIGHTS**  
for 2" weight belt

**Cat. No. 1287-01**



**2" PRO WEIGHT BELT**  
without weights

**Cat. No. 1289**

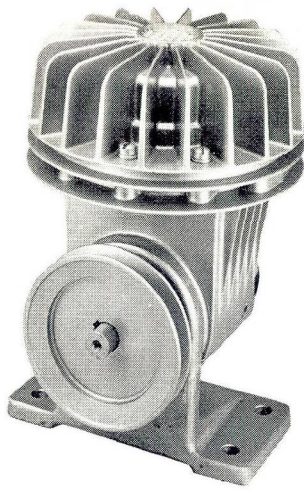

### BARE HOOKAH COMPRESSOR

1. Capacity 3.5 CFM
2. Pressure 100 PSI
3. RPM 1700
4. Weight 9½ Lbs.
5. Pre-lubricated, sealed bearings, no lubrication or filters required.

Cat. No. 744-1

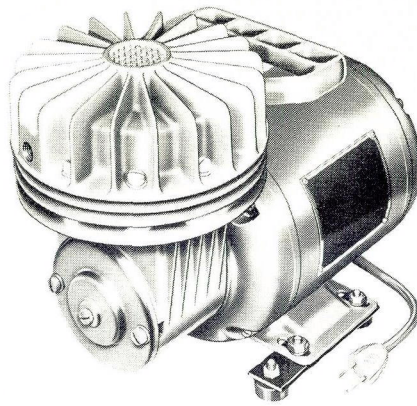

### ELECTRIC COMPRESSOR

1. This model is powered by a 1/3 electric motor coupled directly to Sportsways compressor for minimum weight, size, and maintenance.
2. Capacity 3.5 CFM
3. Weight 34 Lbs.

Cat. No. 744-2

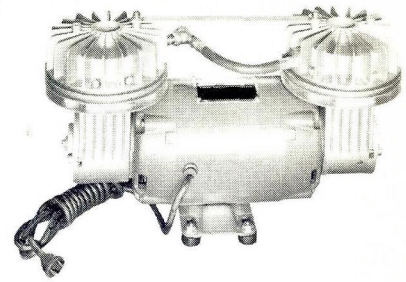

### DOUBLE ELECTRIC COMPRESSOR

1. This model is powered by a 3/4 H.P. electric motor coupled directly for minimum size, weight, and maintenance.
2. Capacity 7 CFM
3. Pressure 100 PSI
4. Weight 61 Lbs.
5. This model can be adapted to reserve tank similar to 744-5.

Cat. No. 744-11

# HOOKAH COMPRESSORS

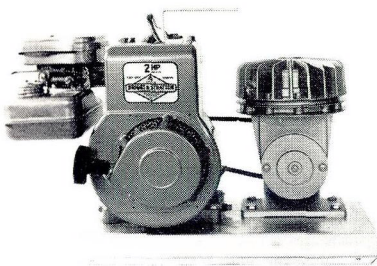

### SINGLE GASOLINE DRIVEN COMPRESSOR

1. 2 H.P. lightweight aluminum air-cooled Briggs and Stratton Motor with recoil starter. Completely portable weighing 37 Lbs. Capacity 3.5 CFM

Cat. No. 744-4

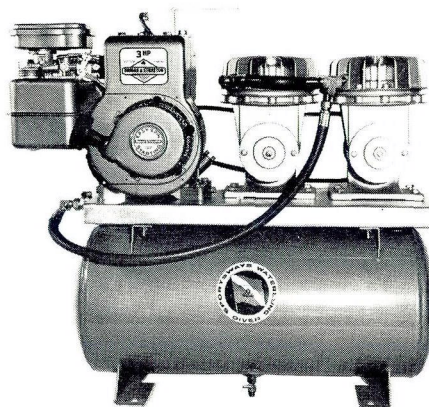

### DOUBLE GASOLINE DRIVEN COMPRESSOR

1. High Pressure light weight aluminum air-cooled Briggs and Stratton Motor with recoil starter.
2. Sportsways compressors mounted in line providing 7 CFM at pressures up to 100 PSI.
3. Commonly used in 100 feet or more.

Cat. No. 744-5 — Double gas compressor only.

Cat. No. 744-12 — Complete with tank, as illustrated.

### ACCESSORIES

1. Cat. No. 1303-01 — 50 ft. length air hose
2. Cat. No. 744-14 — Air Hose Connector
3. Cat. No. 744-15 — Regulator to air hose connector
4. Cat. No. 1306 — 200# Gauge
5. Cat. No. 744-8 — Reserve Tank Flexible Hose Connector
6. Cat. No. 744-16 — Reserve Tank for Single Gasoline Compressor
7. Cat. No. 744-17 — Reserve Tank for Single Electric Compressor
8. Cat. No. 744-18 — Reserve Tank for Double Electric Compressor
9. Cat. No. 744-6 — Reserve Tank for Double Gasoline Compressor
10. Cat. No. 744-7 — Hookah Compressor Hose and Hardware Kit. (Contains the necessary valves, connectors, and hoses to utilize the reserve tank. It contains the following: Flexible hose connector, inlet check valve, adjustable pressure relief valve, drain plug, and all connectors to adapt same.)
11. Cat. No. 744-13 — Service Field Kit includes following: gasket retainer, screen filter, valve plate assembly complete, inlet valve, and air seal.

## SIZE CHART FOR SPORTSWAYS SUITS

	Extra Small	Small	Medium	Large	Extra Large
CHEST	31" - 33"	34" - 36"	37" - 39"	40" - 42"	43" - 46"
WAIST	24" - 26"	27" - 29"	30" - 32"	33" - 35"	36" - 38"
HEIGHT	5'2" - 5'7"	5'5" - 5'9"	5'7" - 6'0"	5'10" - 6'2"	6'0" - 6'4"

## WOMEN SUIT CATALOG NOS.

5130 X-SMALL	5132 MEDIUM	5134 X-LARGE
5131 SMALL	5133 LARGE	



## SUITS:

3/16"	<b>Cat. No.</b>	<b>Size</b>	1/4"	<b>Cat. No.</b>	<b>Size</b>
	5030	Extra-Small		5040	Extra-Small
	5031	Small		5041	Small
	5032	Medium		5042	Medium
	5033	Large		5043	Large
	5034	Extra-Large		5044	Extra-Large



## SUIT JACKETS:

3/16"	<b>Cat. No.</b>	<b>Size</b>	1/4"	<b>Cat. No.</b>	<b>Size</b>
	5030-1	Extra-Small		5040-1	Extra-Small
	5031-1	Small		5041-1	Small
	5032-1	Medium		5042-1	Medium
	5033-1	Large		5043-1	Large
	5034-1	Extra-Large		5044-1	Extra-Large

## SUIT PANTS:

3/16"	<b>Cat. No.</b>	<b>Size</b>	1/4"	<b>Cat. No.</b>	<b>Size</b>
	5030-2	Extra-Small		5040-2	Extra-Small
	5031-2	Small		5041-2	Small
	5032-2	Medium		5042-2	Medium
	5033-2	Large		5043-2	Large
	5034-2	Extra-Large		5044-2	Extra-Large

## HOODS:

TUFSKIN Nylon-Lined, seams sewn at stress points, contoured in such a manner that a near perfect seal around the entire face and neck is assured. 3/16" and 1/4", available in five sizes.

3/16"	<b>Cat. No.</b>	<b>Size</b>	1/4"	<b>Cat. No.</b>	<b>Size</b>
	5030-3	Extra-Small		5040-3	Extra-Small
	5031-3	Small		5041-3	Small
	5032-3	Medium		5042-3	Medium
	5033-3	Large		5043-3	Large
	5034-3	Extra-Large		5044-3	Extra-Large

## BOOTS:

TUFSKIN Nylon-Lined, Hard-sole, zippered boots, all seams sewn at the vital stress points. 3/16" and 1/4", available in seven sizes.

3/16"	<b>Cat. No.</b>	<b>Size</b>	1/4"	<b>Cat. No.</b>	<b>Size</b>
	5030-4	Extra-Small (5-6)		5040-4	Extra-Small (5-6)
	5031-4	Small (7-8)		5041-4	Small (7-8)
	5032-4	Medium (8-9)		5042-4	Medium (8-9)
	5033-4	Medium-Large (9-10)		5043-4	Medium-Large (9-10)
	5034-4	Large (10-11)		5044-4	Large (10-11)
	5035-4	Extra-Large (11-13)		5045-4	Extra-Large (11-13)
	5036-4	Super X-Large (13-15)		5046-4	Super X-Large (13-15)





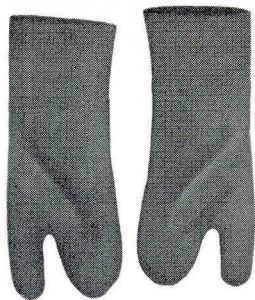

### MITTS:

TUFSKIN Nylon - Lined, three fingered, designed to our exacting demands. 3/16" available in five sizes.

**Cat. No.**  
5030-5  
5031-5  
5032-5  
5033-5  
5034-5

**Size**  
Extra-Small  
Small  
Medium  
Large  
Extra-Large

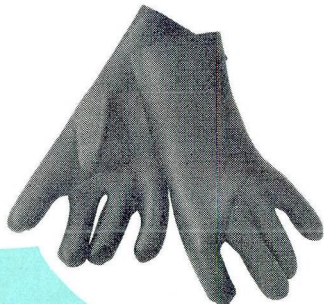

### GLOVES:

TUFSKIN, Nylon - Lined, five fingered glove, manufactured to our exacting demands to create the finger dexterity so vitally necessary for the expert diver. 3/16", available in five sizes.

**Cat. No.**  
5030-6  
5031-6  
5032-6  
5033-6  
5034-6

**Size**  
Extra-Small  
Small  
Medium  
Large  
Extra-Large

# EXPOSURE SUITS

1967 Sportsways underwater exposure suits for men and women, beautifully contoured, made of durable nylon-lined TUFSKIN, 3-piece, 5 Heavy-duty zippers, form fit, under-arm bulging eliminated to a minimum, all seams sewn at stress points, 3/16" and 1/4", available in five sizes Extra-Small, Small, Medium, Large, and Extra-Large. Ideal for water skiing, surfing, and diving. Available in Black, Blue, and Chartreuse.

### SKI JACKET:

TUFSKIN Nylon-Lined short sleeves, with beaver tail, 3/16" and 1/8", available in five sizes.

	<b>Cat. No.</b>	<b>Size</b>
3/16"	5530	Extra-Small
	5531	Small
	5532	Medium
	5533	Large
	5534	Extra-Large

	<b>Cat. No.</b>	<b>Size</b>
1/8"	5520	Extra-Small
	5521	Small
	5522	Medium
	5523	Large
	5524	Extra-Large



### SHORTY SURF & SKI SUIT:

TUFSKIN, Nylon-lined, short sleeves, short legs, 3/16", available in five sizes.

<b>Cat. No.</b>	<b>Size</b>
5630	Extra-Small
5631	Small
5632	Medium
5633	Large
5634	Extra-Large



**VEST:** TUFSKIN, Nylon Lined, no arms, no beaver tail, no zippers, 3/16" and 1/8", available in five sizes.

	<b>Cat. No.</b>	<b>Size</b>
3/16"	5730	Extra-Small
	5731	Small
	5732	Medium
	5733	Large
	5734	Extra-Large

	<b>Cat. No.</b>	<b>Size</b>
1/8"	5720	Extra-Small
	5721	Small
	5722	Medium
	5723	Large
	5724	Extra-Large

**SKI VEST:** TUFSKIN, Nylon-lined, with zipper, no arms, no beaver tail, 3/16" and 1/8" available in five sizes.

	<b>Cat. No.</b>	<b>Size</b>
3/16"	5830	Extra-Small
	5831	Small
	5832	Medium
	5833	Large
	5834	Extra-Large

	<b>Cat. No.</b>	<b>Size</b>
1/8"	5820	Extra-Small
	5821	Small
	5822	Medium
	5823	Large
	5824	Extra-Large

# HOOKAH EQUIPMENT

A HOOKAH UNIT SIMPLY COMBINES THE WATERLUNG REGULATOR AND A SURFACE AIR SUPPLY. THE UNIT IS CONNECTED TO A SURFACE AIR SOURCE BY A MEDIUM PRESSURE HOSE. IDEAL FOR DIVING IN A LIMITED AREA FOR EXTENDED PERIODS OF TIME, SUCH AS FOR GOLD DIVING OR MANY TYPES OF UNDERWATER REPAIR AND SALVAGE.

## HOOKAH HARNESS FOR :

### SINGLE HOSE REGULATOR:

Cat. No. 744-9

Designed to fit all Sportways Single Hose regulators, with easily adjustable nylon straps. Harness comes complete with check valve and adaptable fittings.

### DOUBLE HOSE REGULATOR:

Cat. No. 744-10

Designed to fit all Sportways Double Hose regulators with adjustable nylon straps, check valve and adaptable fittings.

## PHOTO MURALS FOR THE CLUB ROOM — OFFICE — or DEN — UNDERWATER PHOTO MURALS

Giant size 22" x 26" underwater photographs taken by Ron Church depicting diving activity in HAWAII, MEXICO, and CALIFORNIA. TWO COLORS, showing rare black coral, turtle diving, shell diving and underwater photography.

2507 Complete set of 4 prints ..... \$1.50

**MOVIES — UNDERWATER MOVIES** — Clubs, Conventions, Fund raising organizations, meetings, diving promotion or home enjoyment. Here is a chance to purchase an exciting underwater movie to thrill your friends and acquaintances. Two exciting new films photographed and edited by Ron Church 1962 Underwater Photographer of the year. Sound, color, personally narrated.

## "MYSTERIES OF THE GULF" — Gold Medal Winner

A fantastic color film depicting the mysterious underwater creatures of the Gulf of California. 15,000 Barracuda in one school, cleaning stations, garden eels and powerful game fish in feeding behaviors. "A short course in marine biology," 12 min. Sound, color.

2541 ..... \$75.00

## "ADVENTURE UNDERWATER"

Filmed at fabulous CAPE SAN LUCAS, home of the "Rivers of Sand." Exciting scenes catching turtles, spearing powerful game fish and defying a giant barracuda school. Feeding behaviors of predatory fish, a wall of fish. Taken from 35mm Eastman color, photographed and edited by Ron Church. 20 min. Sound, color.

2543 ..... \$100.00

## "ANYONE FOR DIVING"

A thirty-five minute film of general interest and the fun of diving . . . plus an up-to-date instructional aid with 7 min. of Walt Disney animation prologue. 16mm sound — Color . . . 35 min.

2545 ..... \$140.00

## DIVING HANDBOOKS

### DIVING MANUAL — "UNDERWATER RECREATION"

A 72 page technical diving manual, illustrating the proper use of the underwater breathing equipment and skin diving techniques. Charts, photographs and illustrations for thorough readability.

2550 DIVING MANUAL ..... \$2.50

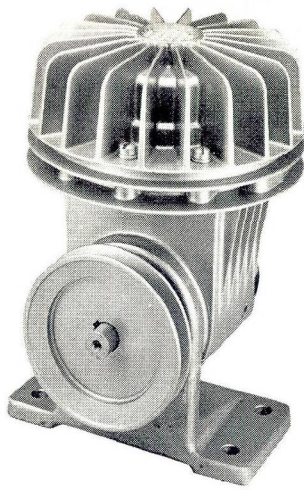

### BARE HOOKAH COMPRESSOR

1. Capacity 3.5 CFM
2. Pressure 100 PSI
3. RPM 1700
4. Weight 9½ Lbs.
5. Pre-lubricated, sealed bearings, no lubrication or filters required.

Cat. No. 744-1

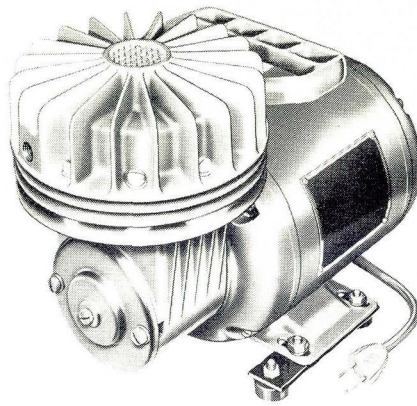

### ELECTRIC COMPRESSOR

1. This model is powered by a 1/3 electric motor coupled directly to Sportsways compressor for minimum weight, size, and maintenance.
2. Capacity 3.5 CFM
3. Weight 34 Lbs.

Cat. No. 744-2

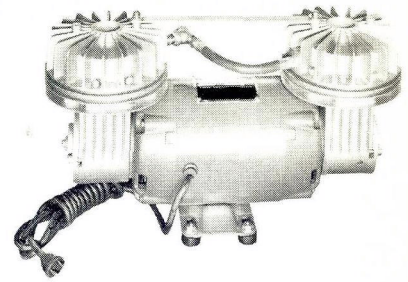

### DOUBLE ELECTRIC COMPRESSOR

1. This model is powered by a 3/4 H.P. electric motor coupled directly for minimum size, weight, and maintenance.
2. Capacity 7 CFM
3. Pressure 100 PSI
4. Weight 61 Lbs.
5. This model can be adapted to reserve tank similar to 744-5.

Cat. No. 744-11

# HOOKAH COMPRESSORS

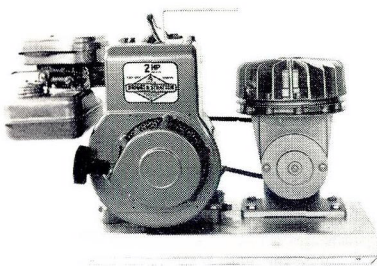

### SINGLE GASOLINE DRIVEN COMPRESSOR

1. 2 H.P. lightweight aluminum air-cooled Briggs and Stratton Motor with recoil starter. Completely portable weighing 37 Lbs. Capacity 3.5 CFM

Cat. No. 744-4

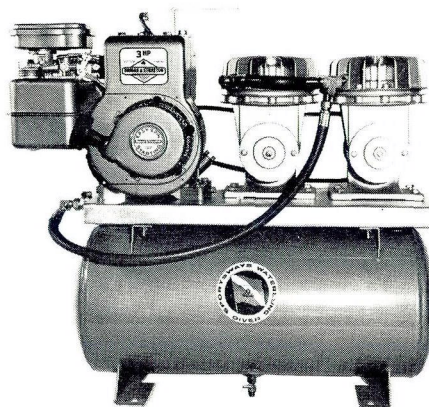

### DOUBLE GASOLINE DRIVEN COMPRESSOR

1. High Pressure light weight aluminum air-cooled Briggs and Stratton Motor with recoil starter.
2. Sportsways compressors mounted in line providing 7 CFM at pressures up to 100 PSI.
3. Commonly used in 100 feet or more.

Cat. No. 744-5 — Double gas compressor only.

Cat. No. 744-12 — Complete with tank, as illustrated.

### ACCESSORIES

1. Cat. No. 1303-01 — 50 ft. length air hose
2. Cat. No. 744-14 — Air Hose Connector
3. Cat. No. 744-15 — Regulator to air hose connector
4. Cat. No. 1306 — 200# Gauge
5. Cat. No. 744-8 — Reserve Tank Flexible Hose Connector
6. Cat. No. 744-16 — Reserve Tank for Single Gasoline Compressor
7. Cat. No. 744-17 — Reserve Tank for Single Electric Compressor
8. Cat. No. 744-18 — Reserve Tank for Double Electric Compressor
9. Cat. No. 744-6 — Reserve Tank for Double Gasoline Compressor
10. Cat. No. 744-7 — Hookah Compressor Hose and Hardware Kit. (Contains the necessary valves, connectors, and hoses to utilize the reserve tank. It contains the following: Flexible hose connector, inlet check valve, adjustable pressure relief valve, drain plug, and all connectors to adapt same.)
11. Cat. No. 744-13 — Service Field Kit includes following: gasket retainer, screen filter, valve plate assembly complete, inlet valve, and air seal.



**Cat. No. 721-8,**  
Divers' Utility Float with tube.

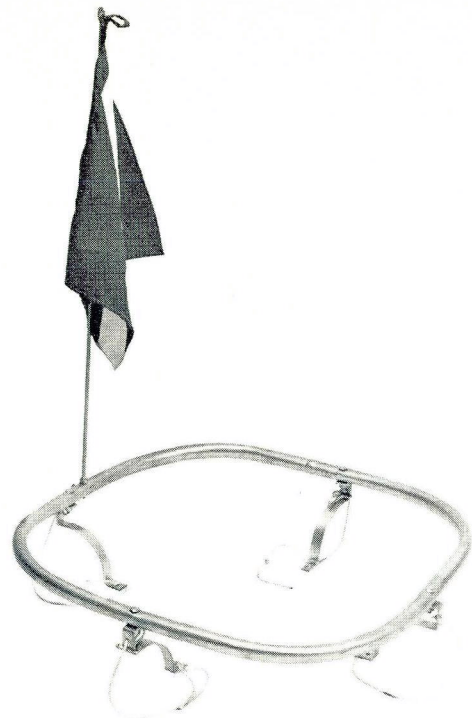

**Cat. No. 721-9,**  
Divers' Utility Float without tube.

## ACCESSORIES



**Cat. No. 1226,**  
4X Spray (16 oz. can)



**Cat. No. 1227,**  
4X Compound (8 oz. tube)



**Cat. No. 1576,**  
Magic Bond Cement



### "WATERLUNG" REGULATOR CARRY BAG

Gold expandable vinyl trimmed with black vinyl nylon zipper.

721-3



### CARRY-ALL BAG

All heavy-duty canvas material with water-proof backing. Double brass zipper. Double handles. Reinforced bottom. Ideal for carrying masks, fins, snorkels, gauges, suits, regulators, etc.

721-2



### LOBSTER BAG

World's newest amphibian. On land a catchall for lugging flippers, mask, hood, and other gear. Under water it hangs out of the way on wrist, float, or float-line. Snaps open at a touch to swallow up fish, lobster, abalone, scallops, marine or mineral specimens.

The Lobster Bag won't rip, rot or bust. Its light, strong nylon mesh that can't cause excessive drag in water.

721-4

# ACCESSORIES FOR DIVERS

### PORT-A-LIFT

A submersible lifting device. Lift anchors, motors, wreckage, moorings, small boats, cannons, timbers, salvage of all kinds.

Any depth, any weight — up to rated capacity. The 100-pounder uses only 3½ cubic feet at a depth of 33 feet (about 2 minutes of your air supply). The 200-pounder uses 7. Larger Port-A-Lifts call for the use of a spare tank: 17 cubic feet of air for the 500-pounder, or 33 for the 1000 pounder (at a depth of 33 feet).

Made of rugged vinyl, fully vented to prevent over-expansion during ascent.



721-5 200 lbs.  
721-6 500 lbs.



Cat. No. 1424, SWA-600, Watch.

### MEN'S WATCH

Cat. No. 1423 — 36 m.m.  
Cat. No. 1424 — 42 m.m.

17 Jewels, incabloc, Sweepsecond hand, steel assortments, nickel balance A annulaire, Navarox hairspring, Anti-magnetic, unbreakable main spring Nivaflex, metal dials black with luminous dots and hands, all steel cases, Super Compressor 100% waterproof, no condensation, with internal rotary bezel. Guaranteed to 20 atmospheres, waterproof crowns Monoflex. Available in sizes 42 m.m. or 36 m.m., Black dial only.

### MEN'S WATCH

Cat. No. 1426

Same as above with external bezel. Size 36 m.m. only, Black dial only.

### LADIES WATCH

Cat. No. 1427

17 Jewels, incabloc, Sweepsecond hand, steel assortments, nickel balance A annulaire, Nivarox hairspring, luminous dots and hands on dials, unbreakable main-spring Nivaflex, 100% waterproof, external bezel, guaranteed to 20 atmospheres.



*Retailers:  
Ask us about our  
policies & terms!*

**SN**  
**SPORTSWAYS**

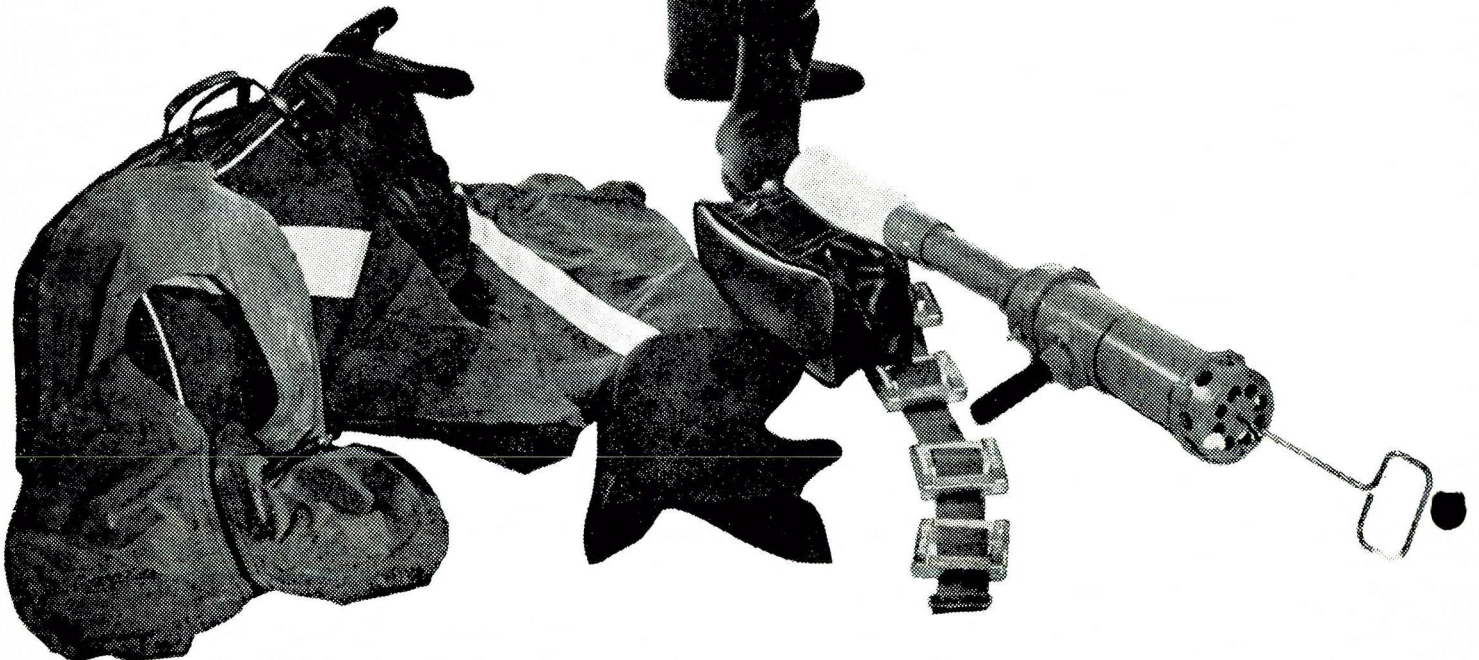

7701 EAST COMPTON BLVD. PARAMOUNT, CALIF. 90724,

Phone (213) 636-0161

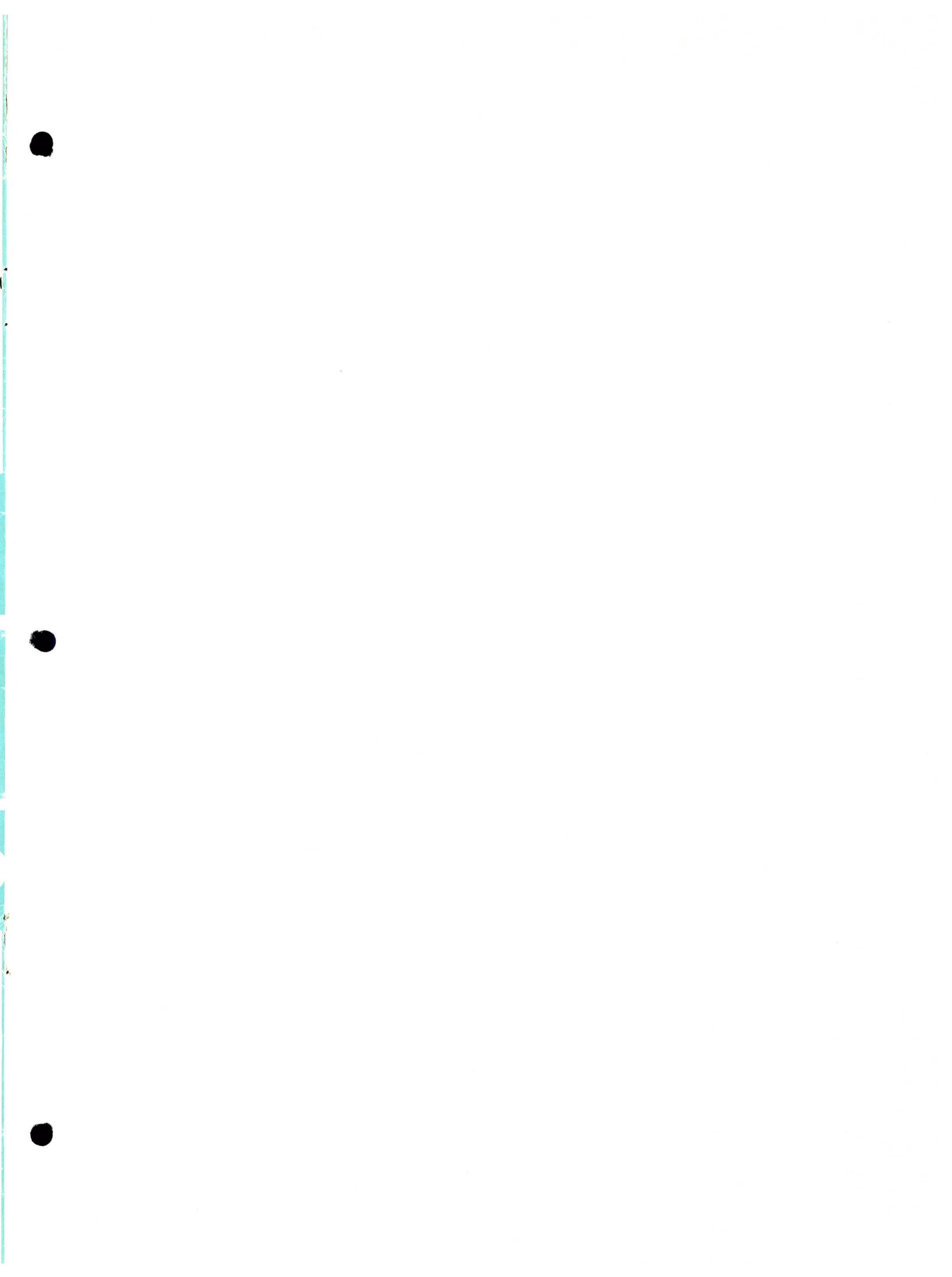

**SN**

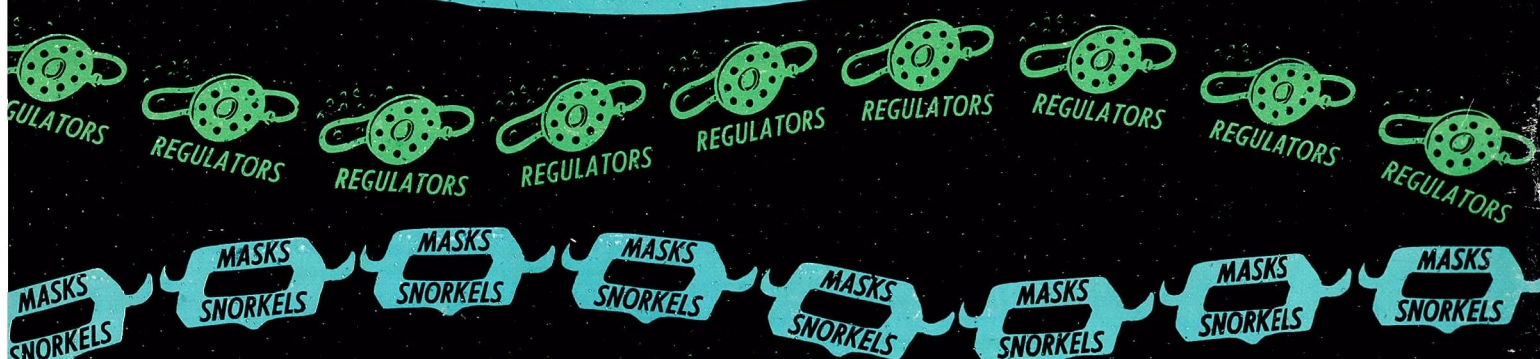
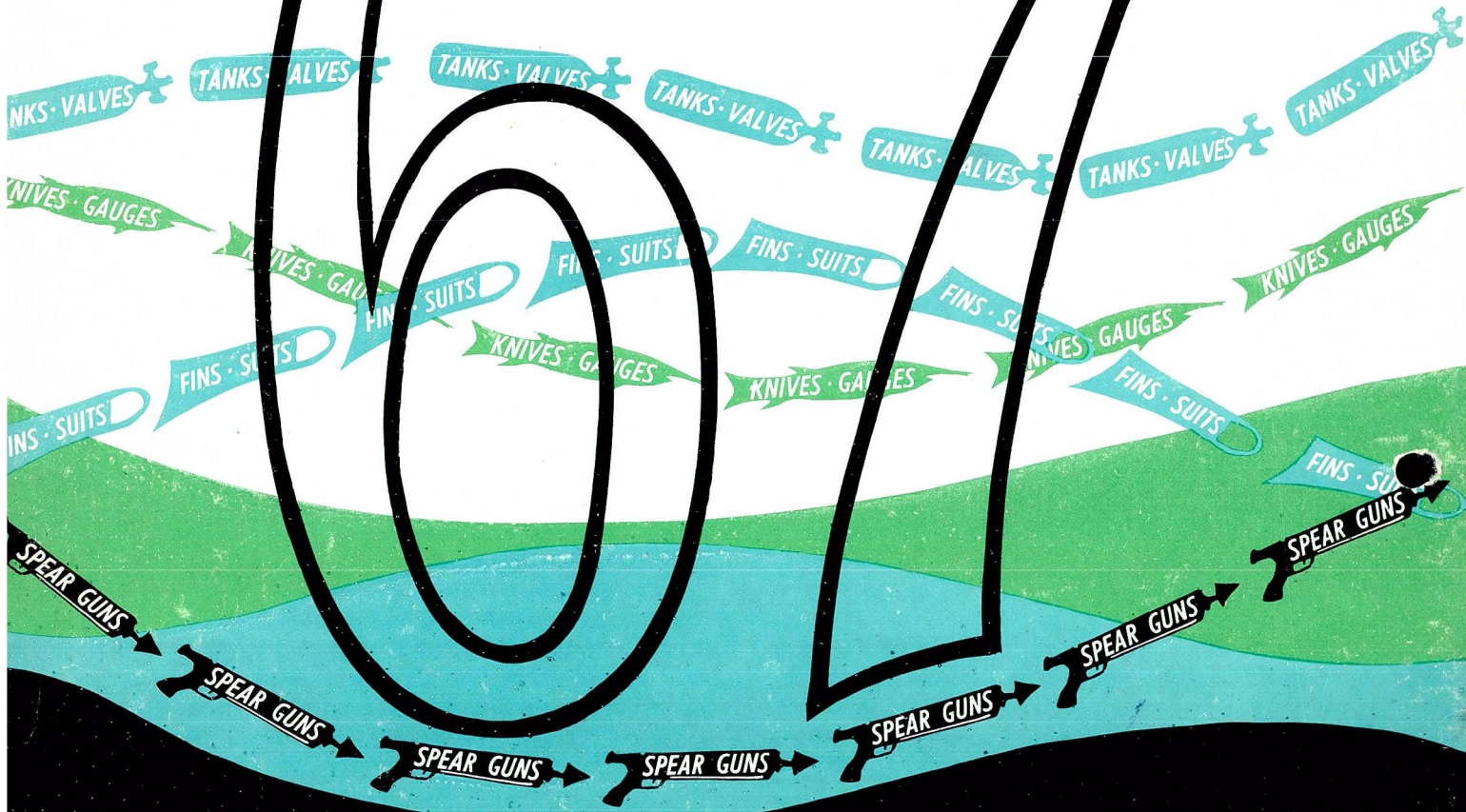

# SPORTSWAYS

7701 EAST COMPTON BLVD. PARAMOUNT, CALIF. 90724, Phone (213) 636-0161